

## Safety Relay with double contacts monostable OA 5621, OA 5622

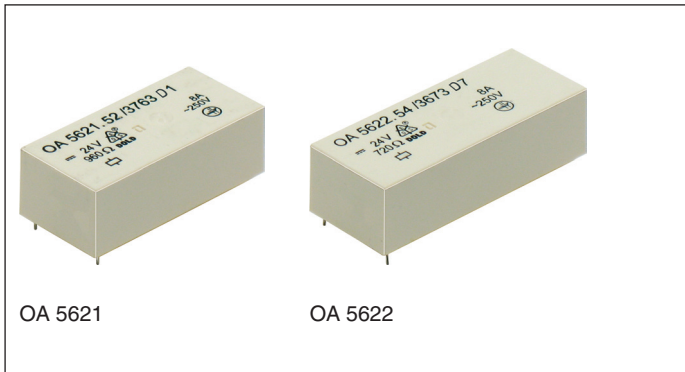

- Acc. to DIN EN 50205, DIN EN 61810-1, DIN EN 60664-1
- High switching safety because of gold plated double contacts
- Low rated power consumption
- Clearance and creepage distances  $\geq 5.5$  mm;
- that means double and reinforced insulation between all circuits
- High mechanical service life
- High temperature range
- High thermal continuous current
- Extremely flat: only 15.5 mm high
- Contact gap  $> 0.5$  mm over entire service life, even when underfault and at  $1.2 U_N$
- Voltage range  $0.75 \dots 1.2 U_N$

### Applications

- To be used in electrical circuits for safety applications
- Escalators and walkways
- Elevators for men and load
- Railway technology

### Approvals and Marking



<sup>1)</sup> pending

### Technical Data

Relay type		OA 5621	OA 5622	OA 5622.50
<b>1.0 Coil</b>				
1.1 Nominal voltage	DC V	6, 12, 24, 48, 60, 110 or others on request		
1.2 Nominal consumption	W	0.6	0.8	0.9
1.11 Voltage range	$U_N$	0.75 ... 1.2		
1.12 Thermal resistance	K/W	55 (mounting distance between relays $\geq 5$ mm)		
1.13 Holding capacity	mW	$\geq 150$	$\geq 200$	$\geq 225$
<b>2.0 Contacts</b>				
2.1 Contact arrangement		2 NO / 2 NC 3 NO / 1 NC	3 NO / 3 NC 4 NO / 2 NC 5 NO / 1 NC	2 NO / 4 NC
2.2 Contact material		AgNi + 5 $\mu$ m Au		
2.3 Rated insulation voltage	AC V	250		
Switching voltage min./max	V	AC/DC 100 mV / AC/DC 60 V (AC 250 V, DC 220 V) <sup>1)</sup>		
2.4 Limiting continuous current $I_{th}$	A	3 x 5	5 x 5 (s. operating voltage limit curve)	
Switching current min./max	A	AC/DC 1 mA / 0.3 A (AC 5 A, DC 3 A) <sup>1)</sup>		
2.5 Switching power min./max.	VA	1 mVA / 7 VA (1250 VA) <sup>1)</sup>		
Switching power min./max.	W	1 mW / 7 W (120 W) <sup>1)</sup>		
2.6 Switching capacity				
to IEC/EN 60947-5-1 AC 15	AC V/A		NO: 250 / 3	NC: 250 / 1
to IEC/EN 60947-5-1 DC 13	DC V/A		NO: 24 / 2	NC: 24 / 2
at 0.1 Hz	DC V/A		NO: 24 / 4	NC: 24 / 4
to UL 508			B300 / Q 300	
2.7 Electrical life		at 1 s On, 1 s Off (see contacts service life)		
at AC 230 V, 5 A, $\cos\phi = 1$	switching cycles	$> 2 \times 10^5$ AgNi 0.15		
at DC 24 V, 3 A ohmic	switching cycles	$> 1.5 \times 10^5$ AgNi 0.15		
2.8 Switching frequency max	switching cycles / s	10		
2.9 Response time / Release time	ms	typically 12 / typically 8		
2.10 Contact force	cN	$\geq 8$		
2.13 Contact resistance	m $\Omega$	$\leq 100$ (DC 2 V, 100 mA)		
2.14 Contact gap	mm	$> 0.5$ <sup>2)</sup>		
<b>3.0 Other</b>				
3.1 Mechanical life	switching cycles	$> 20 \times 10^6$		
3.2 Temperature range	$^{\circ}$ C	- 40 ... + 80		
3.3 Degree of protection, housing		Wash proof RT III		
3.5 Vibration resistance		NO: 10 ... 200 Hz; 10 g; NC: 10 ... 140 Hz $\leq 5$ g; IEC/EN 60068-2-6		
3.6 Climate resistance		Humid heat IEC/EN 60068-2-30		
3.7 Short circuit strength 1 kA / AC 250 V	AgNi	NO: 10 AgL / NC: 6 AgL EN 60947-5-1		

<sup>1)</sup> these higher values are possible but the gold plate will be destroyed

<sup>2)</sup> over entire service life, even when under fault and at  $1.2 \times U_N$

## Technical Data

3.8 Insulation acc. to IEC 60664-1, EN 50178			
Rated insulation voltage	AC V	250	
Contamination level		2	
Overvoltage category		III	
Test voltage			
Contact-coil (1 min)	AC kV eff.	≥ 4	
Contact-contact (1min)	AC kV eff.	≥ 4	
Open contact acc. to DIN EN 61810-1	AC kV eff.	1.5	
Transient voltage			
Contact-coil (1,2 - 50 μs)	kV	≥ 6	
Clearance and creepage distance	mm	≥ 5,5	
3.9 Weight	g	approx. 35	approx. 38
4.0 Packing unit			
4.1 on cardboard in slipcase	piece	25	20
4.2 in case package	piece	250	200
5.0 Solder method			
5.1 Solder method /-temperature /-duration	°C / s	Wafer soldering / 260 / 5	

## Design Versions

U <sub>N</sub> (DC V)	Voltage range (DC V)	OA 5621			OA 5622					
		R <sub>Coil</sub> Ω ± 10%	.48 3NO, 1NC	.52 2NO, 2NC	R <sub>Spule</sub> Ω ± 10%	.18 3NO, 3NC	.54 4NO, 2NC	.60 5NO, 1NC	R <sub>Coil</sub> Ω ± 10%	.50 2NO, 4NC
AgNi 0,15-contacts + 5 μm Au										
6	4,5 ... 8,4	60	3791	3801	45	3821	3831	3841	38	3851
12	9,0 ... 16,8	240	3792	3802	180	3822	3832	3842	150	3852
24	18,08 ... 33,6	960	3793	3803	720	3823	3833	3843	600	3853
48	36,0 ... 67,2	3840	3794	3804	2880	3824	3834	3844	2425	3854
60	45,0 ... 84,0	6000	3795	3805	4500	3825	3835	3845	3790	3855
110	82,5 ... 154,0	20000	3796	3806	15125	3826	3836	3846	12735	3856

## Ordering Example

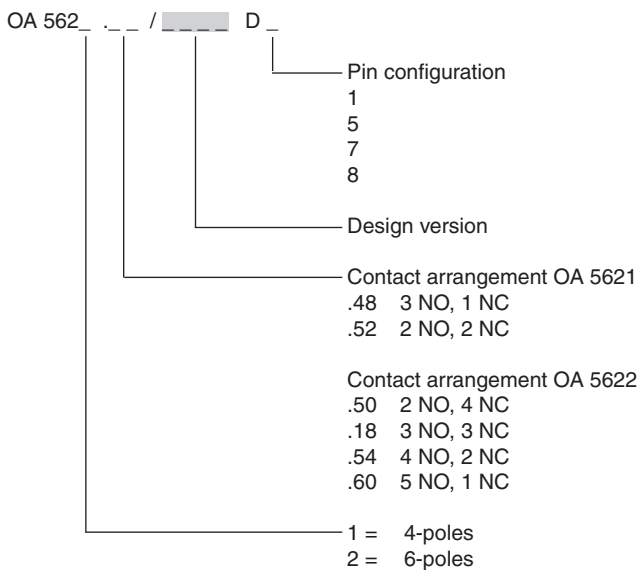

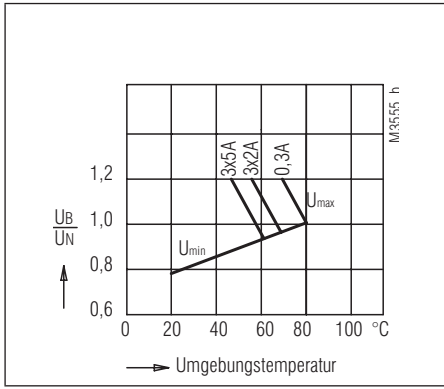

Operating voltage limit curve OA 5621

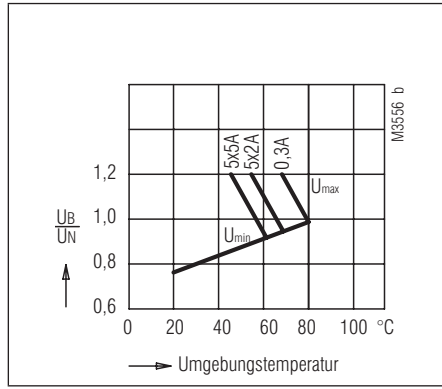

Operating voltage limit curve OA 5622

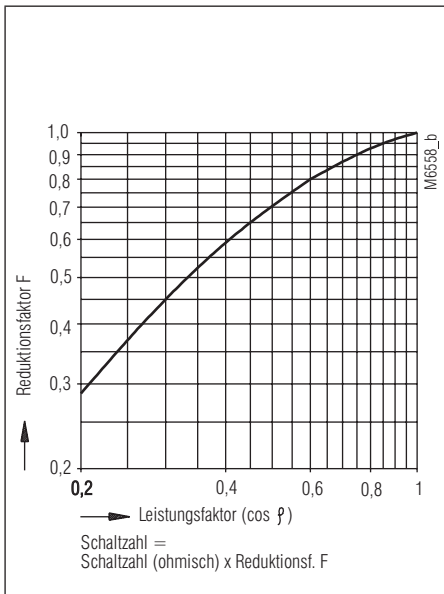

Reduction factor for inductive loads

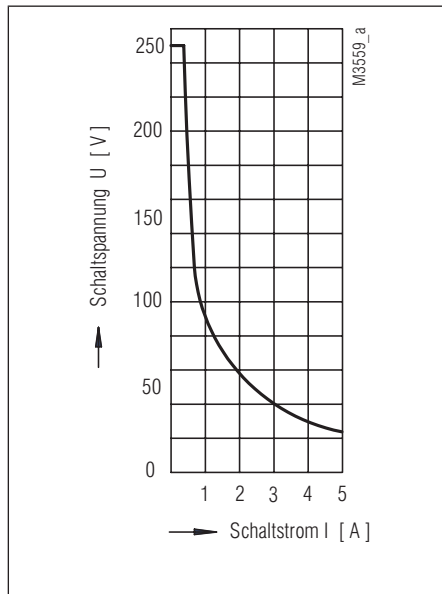

Limit curve for arc-free operation (load limit curve)

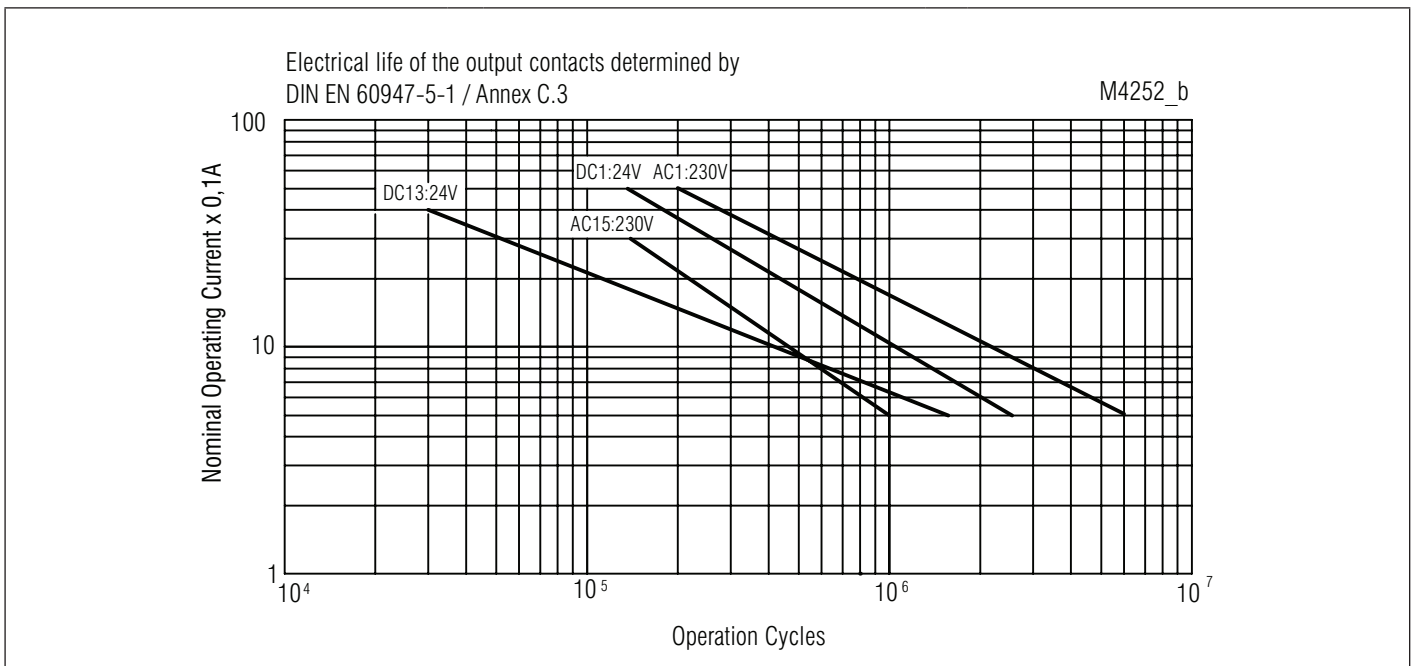

Electrical life

Pin Configurations D1 / D5

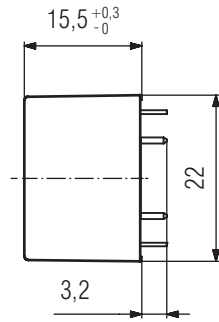
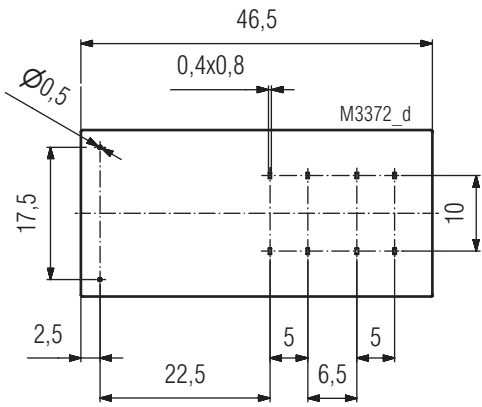

Pin Configuration D1  
Drilling plan (solder side)

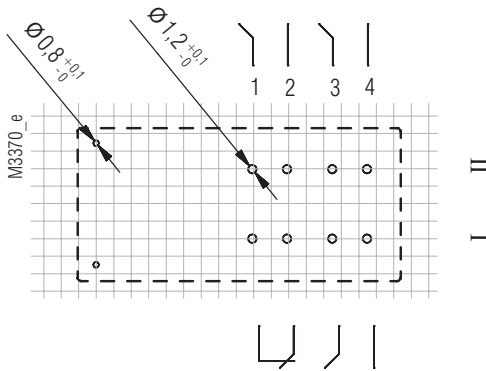

OA5621.48/\_\_\_D1 3NO / 1NC

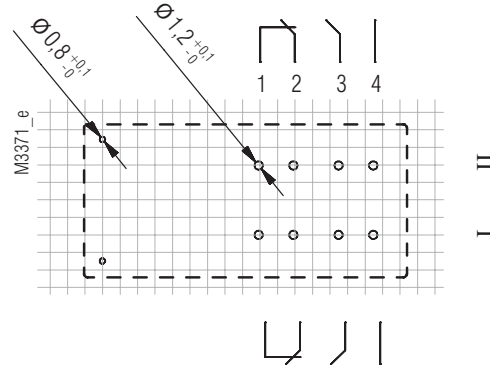

OA5621.52/\_\_\_D1 2NO / 2NC

Pin Configuration D5  
Drilling plan (solder side)

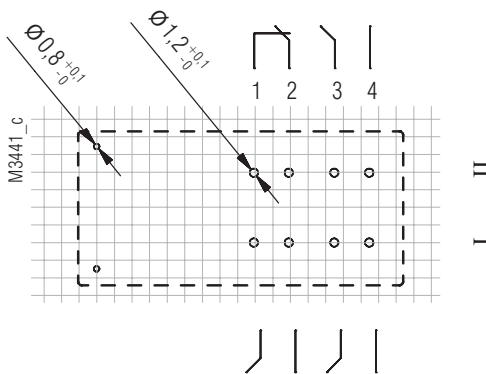

OA5621.48/\_\_\_D5 3NO / 1 NC

Connection for basic grid dimensions 2,50 mm as well as 2,54 mm according to DIN EN 60097, DIN EN 60326

Pin Configurations D7 / D8

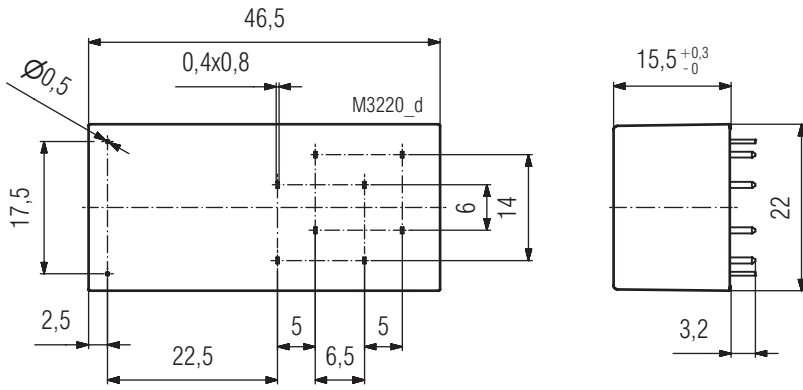

Pin Configuration D7  
Drilling plan (solder side)

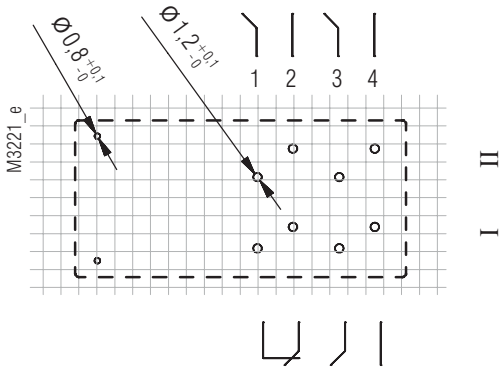

OA5621.48/\_\_\_D7 3NO / 1NC

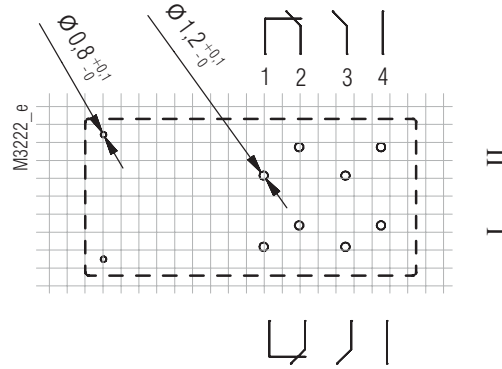

OA5621.52/\_\_\_D7 2NO / 2NC

Pin Configuration D8  
Drilling plan (solder side)

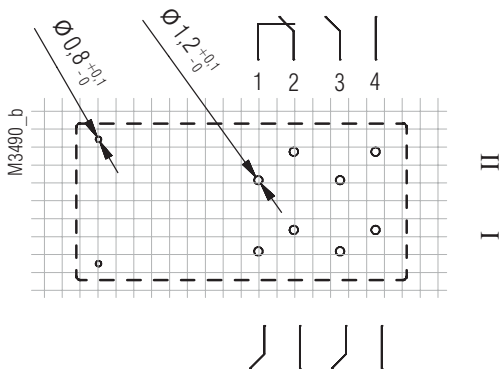

OA5621.48/\_\_\_D8 3NO / 1NC

Connection for basic grid dimensions 2,50 mm as well as 2,54 mm according to DIN EN 60097, DIN EN 60326

Pin Configurations D1 / D5

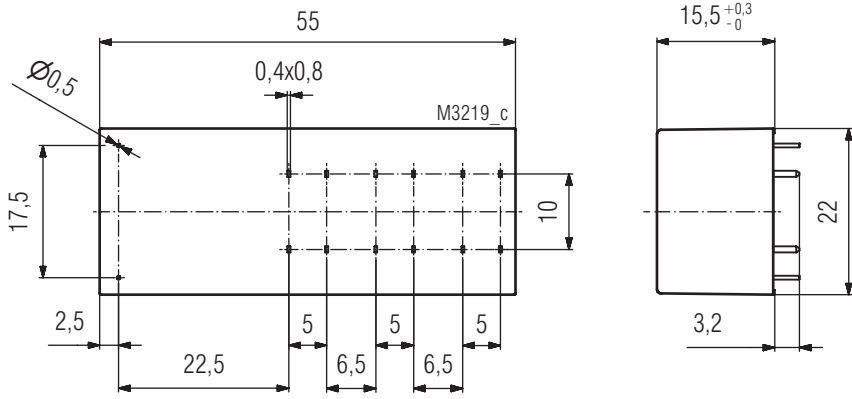

Pin Configuration D1  
Drilling plan (solder side)

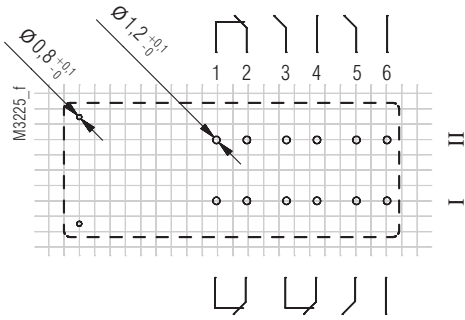

OA 5622.18/\_\_\_D1 3NO / 3NC

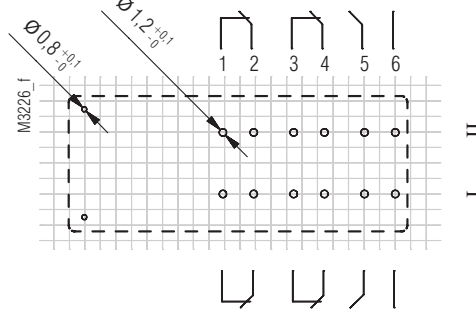

OA 5622.50/\_\_\_D1 2NO / 4NC

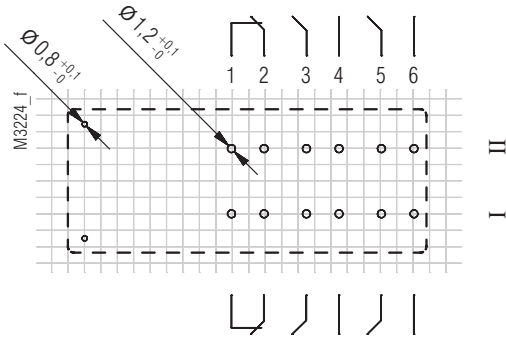

OA 5622.54/\_\_\_D1 4NO / 2NC

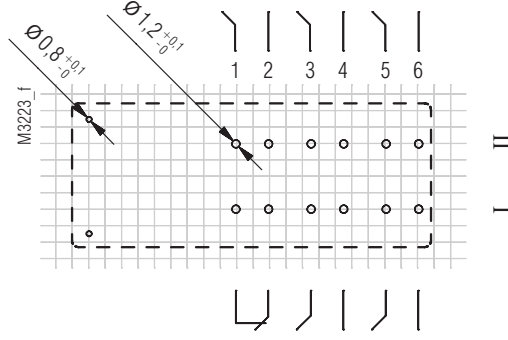

OA 5622.60/\_\_\_D1 5NO / 1NC

Pin Configuration D5  
Drilling plan (solder side)

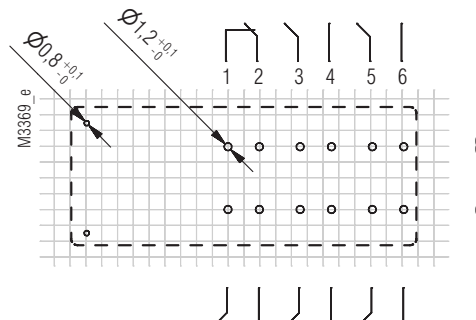

OA 5622.60/\_\_\_D5 5NO / 1NC

Connection for basic grid dimensions 2,50 mm as well as 2,54 mm according to DIN EN 60097, DIN EN 60326

Pin Configuration D7

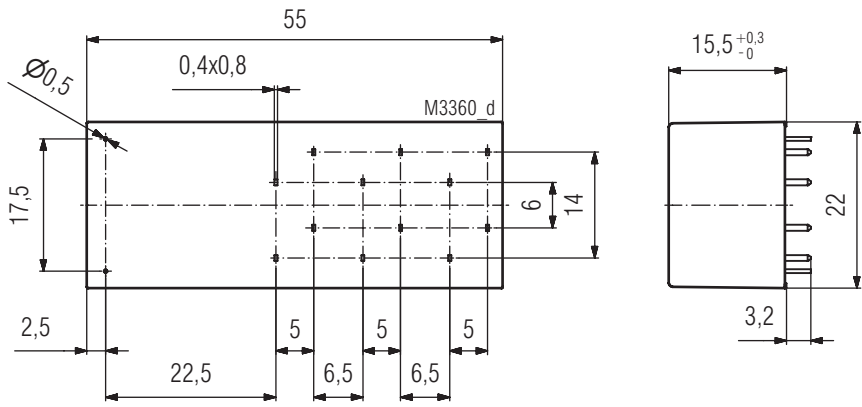

Pin Configuration D7  
Drilling plan (solder side)

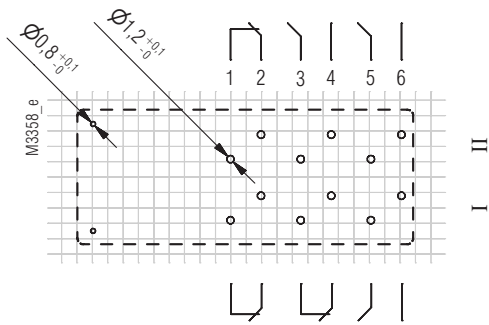

OA 5622.18/\_\_\_D7 3NO / 3NC

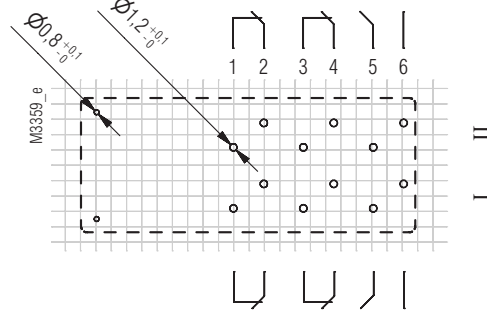

OA 5622.50/\_\_\_D7 2NO / 4NC

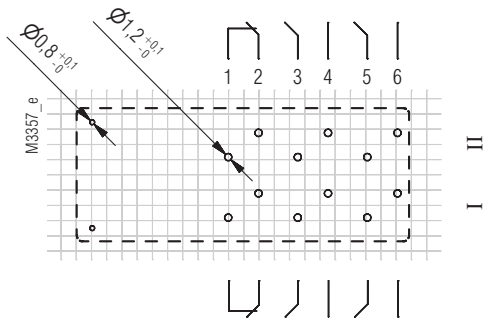

OA 5622.54/\_\_\_D7 4NO / 2NC

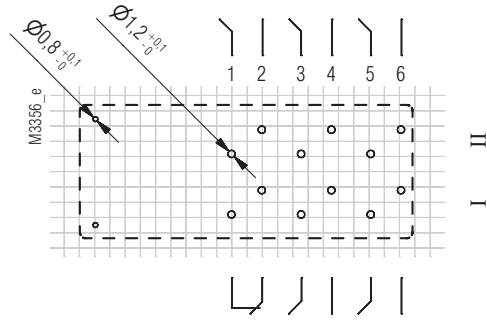

OA 5622.60/\_\_\_D7 5NO / 1NC

Pin Configuration D8  
Drilling plan (solder side)

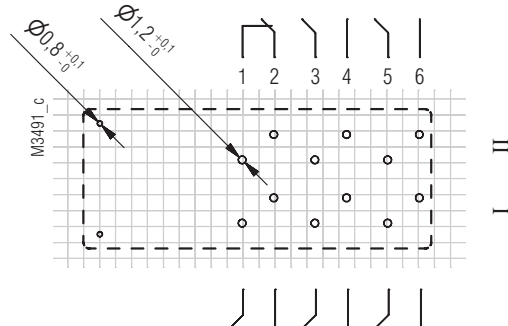

OA 5622.48/\_\_\_D8 3NO / 1NC

OA 5622.60/\_\_\_D8 5NO / 1NC

Connection for basic grid dimensions 2,50 mm as well as 2,54 mm according to DIN EN 60097, DIN EN 60326

Socket ET 1415.035

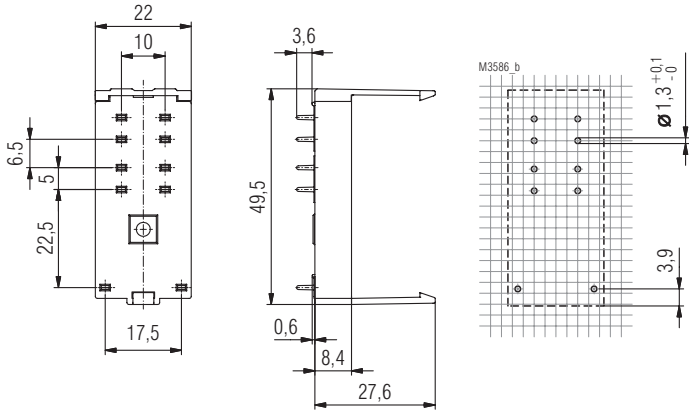

Article number: 0059509

Socket ET 1415.037

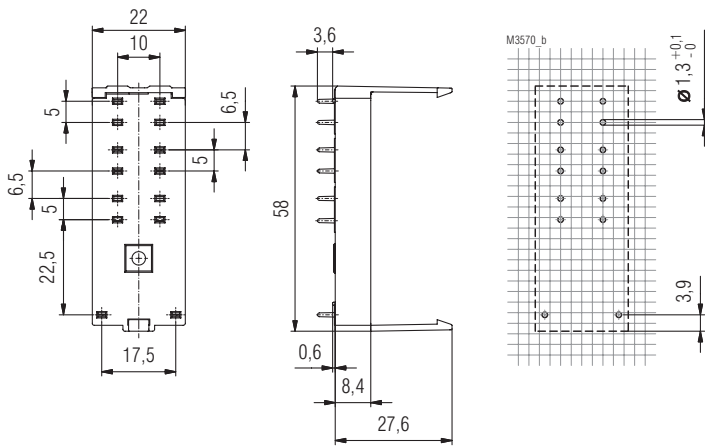

Article number: 0059275