

# 5 WIRE RESISITIVE TOUCH PANEL

## Product Specification

|                       |                              |
|-----------------------|------------------------------|
| <b>CUSTOMER</b>       |                              |
| <b>PRODUCT NUMBER</b> | <b>DTS416-1210-0F Series</b> |

| INTERNAL APPROVALS |             |                  |
|--------------------|-------------|------------------|
| Product Manager    | Engineering | Document Control |
|                    |             |                  |

## TABLE OF CONTENTS

|    |   |    |
|----|---|----|
| 1  | MAIN FEATURES .....                                 | 4  |
| 2  | MECHANICAL DRAWING .....                            | 5  |
| 3  | OPTICAL CHARACTERISTICS .....                       | 6  |
| 4  | ELECTRICAL CHARACTERISTICS .....                    | 6  |
| 5  | MECHANICAL CHARACTERISTICS .....                    | 7  |
| 6  | RELIABILITY .....                                   | 7  |
| 7  | DURABILITY .....                                    | 7  |
| 8  | INSPECTION METHODS.....                             | 8  |
| 9  | APPEARANCE INSPECTION .....                         | 9  |
| 10 | ATTENTION FOR MOUNTING .....                        | 10 |
| 11 | PART NUMBER DESCRIPTION FOR AVAILABLE OPTIONS ..... | 11 |
| 12 | HANDLING PRECAUTIONS .....                          | 11 |

**REVISION RECORD**

| <b>Rev.</b> | <b>Date</b> | <b>Page</b> | <b>Par.</b> | <b>Comment</b>      | <b>ECN no.</b> |
|-------------|-------------|-------------|-------------|---------------------|----------------|
| A           | 07/26/10    | --          | --          | Initial DCA Release | E4338          |
|             |             |             |             |                     |                |
|             |             |             |             |                     |                |
|             |             |             |             |                     |                |
|             |             |             |             |                     |                |
|             |             |             |             |                     |                |
|             |             |             |             |                     |                |
|             |             |             |             |                     |                |
|             |             |             |             |                     |                |

# 1 MAIN FEATURES

| ITEM                  | CONTENTS  | UNIT |
|-----------------------|---|------|
| Type                  | Five-Wire Analog Resistive                              | --   |
| Input Mode            | Stylus or Finger  | --   |
| Construction          | Glass-Film-Glass  | --   |
| Frame Size            | 271.27 ± 0.30 (W) x 205.74 ± 0.30 (H) x 2.47 ± 0.30 (D) | mm   |
| Top Glass Area        | 260.77 ± 0.30 (W) x 202.74 ± 0.30 (H)                   |      |
| Viewing Area          | 252.87 ± 0.20 (W) x 191.4 ± 0.20 (H)                    | mm   |
| Active Area           | 248.87 ± 0.20 (W) x 187.4 ± 0.20 (H)                    | mm   |
| Tail Length           | 205.00 ± 6.00   | mm   |
| Operation Temperature | -10 ~ +70 (20% RH ~ 90% RH) (note 1.1)                  | °C   |
| Storage Temperature   | -40 ~ +80 (10% RH ~ 90% RH) (note 1.1)                  | °C   |
| RoHS Compliant        | Yes   | --   |

Note 1.1: All terms under 1 atmosphere:

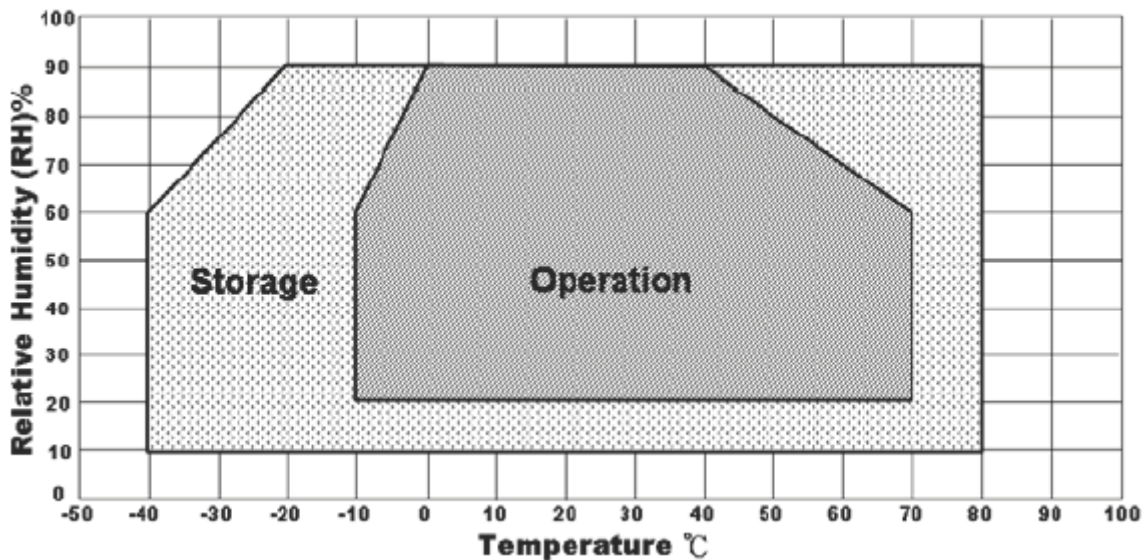

## 2 MECHANICAL DRAWING

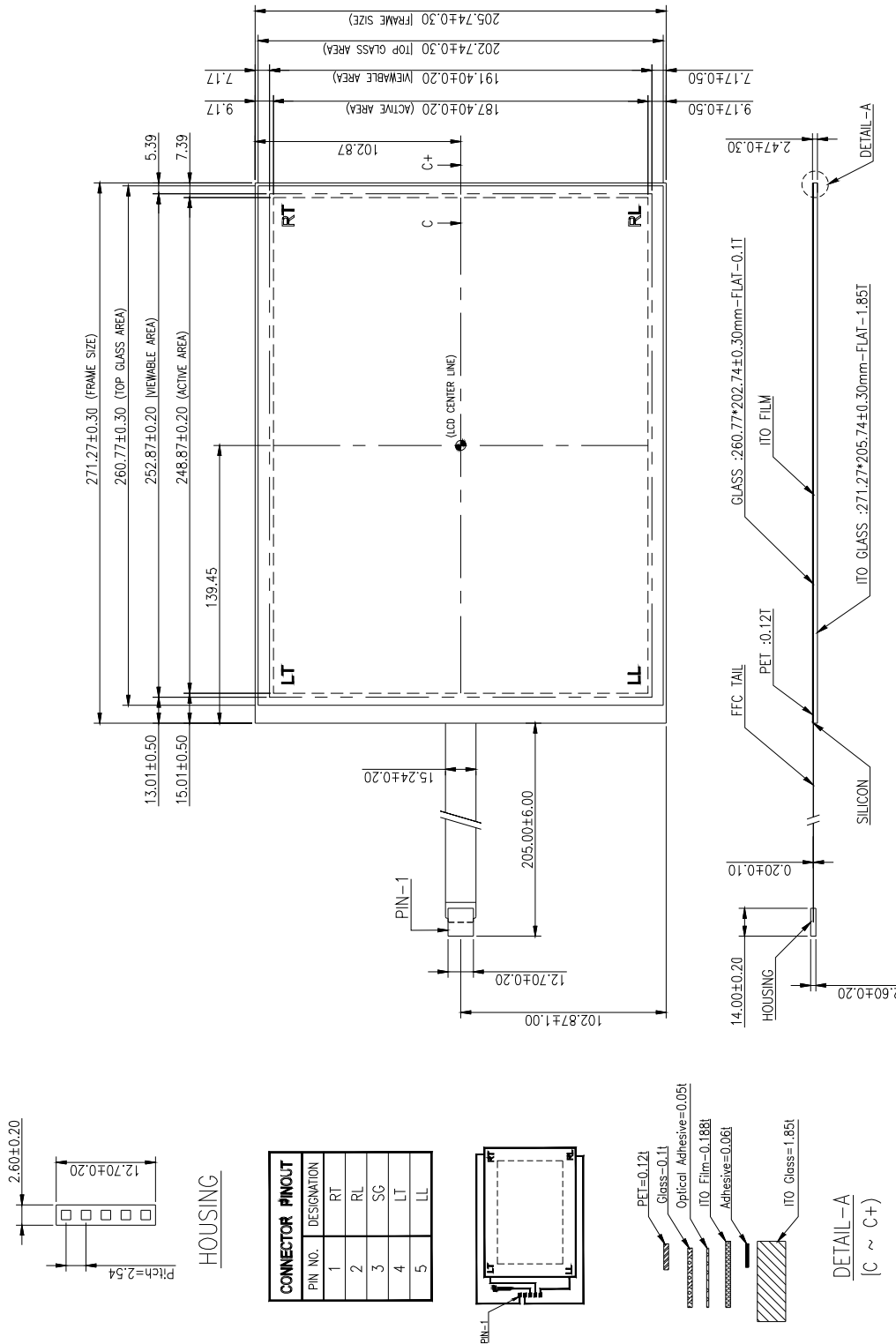

Recommended touch decoder kit:  
Controller: TSC400-12E-000 (USB)  
TSC600-02E-000 (RS-232)  
Cable: TSC-2P30-000 (Pin to Pin Cable)  
TSCC-1E-000 (USB External Cable)  
TSCC-0E-000 (RS-232 External Cable)

Recommended Mating Connector:  
Molex 0015912055  
Molex 0022052051

### 3 OPTICAL CHARACTERISTICS

| Item         | Specifications   |
|--------------|--|
| Transparency | 80% ± 3% (clear type measured by BYK-Gardner at 550nm) |
| Haze         | 4.5% ± 3%  |

### 4 ELECTRICAL CHARACTERISTICS

| Item            | Specifications                                 |
|-----------------|--|
| Loop Resistance | X: 20 ~ 500Ω, Y: 20 ~ 500Ω (see note 4.1)      |
| Linearity       | $X \leq 1.5\%$ , $Y \leq 1.5\%$ (see note 8.1) |
| Chattering      | ≤ 15ms   |
| Insulation      | ≥ 20MΩ / 25V (DC)                              |
| Endurance       | No acting damage at DC 50V / 60 sec.           |

Note 4.1:

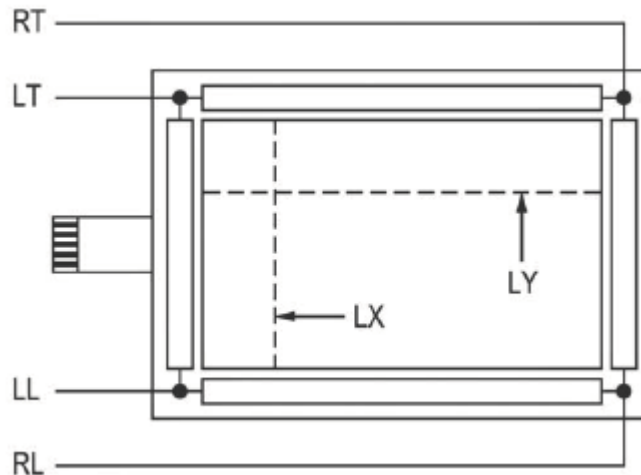

Loop Resistance X = short RT and RL, short LT and LL,  
measure the resistance between RT and LT  
Loop Resistance Y = short RT and LT, short RL and LL,  
measure the resistance between RT and RL

## 5 MECHANICAL CHARACTERISTICS

| Item  |                 | Specifications                                 | Condition  |
|-------|-----------------|--|--|
| Panel | Operating Force | Stylus = R 0.8                                 | ≤ 100g   |
|       | Impact          | 25.0 Dia. Steel Ball / 67g<br>Height = 100 cm  | 1 time, no damage [Impact at center point].        |
|       | Static Load     | 5kg within 10 cm <sup>2</sup> area for 30 sec. | Satisfy (1) of item 7 and (1), (2), (4) of item 6. |
|       | Hardness        | 7 H pencil, pressure 750g / 45°                | ≥ 7 H  |
| FFC   | Peeling         | 800g by vertical 90°                           | Satisfy (1) of item 6.                             |
|       | Bending         | 90° 10 times Up & Down                         | Satisfy (1) of item 6.                             |

## 6 RELIABILITY

| Item  |                      | Specifications   | Condition  |
|-------|----------------------|--|--|
| Panel | High Temp./ Humidity | 70°C/ 90% RH, 240 hrs, allow panel to stay in normal environment for 4 hrs.                        | Reliability test may cause the film puffed yet the electric characteristics stay intact. (1), (2) of item 5; (1), (4) of item 6; (2) of item 6 satisfies X ≤ 2.5%, Y ≤ 3.0%. |
|       | High Temp.           | 70°C/ 240 hrs allow panel to stay in normal environment for 4 hrs.                                 |  |
|       | Low Temp.            | -40°C/ 1000 hrs allow panel to stay in normal environment for 4 hrs.                               |  |
|       | Thermal Cycle        | -40°C ~ 70°C<br>[60 min./cycle] x 100 cycles. Allow panel to stay in normal environment for 4 hrs. |  |

## 7 DURABILITY

| Item  |            | Specifications   | Condition  |
|-------|------------|------------------|--|
| Panel | Knock Test | 10,000,000 times | Satisfy (1), (2) of item 5; (1), (4) of item 6; (2) of item 6 satisfies.<br>X ≤ 2.5%, Y ≤ 3.0% |

## 8 INSPECTION METHODS

### (1). Linearity

Step 1: Short RT and RL (or short RL and LL).

Step 2: Apply voltage DC 5V.

Step 3: Short LT and LL (or short RT and LT).

Step 4: Apply grounding.

Step 5: Draw points along Lx and Ly at 5.0 mm intervals within pattern area and detect the voltage at SG.

Step 6: Measure the voltage differences between RT and LT (or RT and RL) (see note 8.1 & 8.2)

Note 8.1:

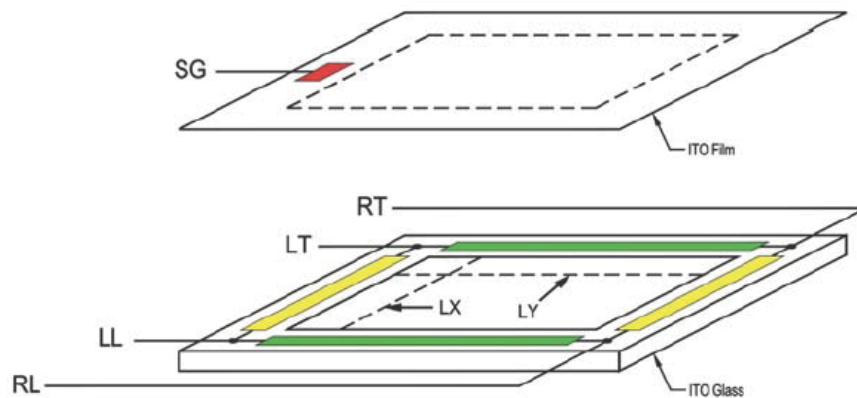

Note 8.2:

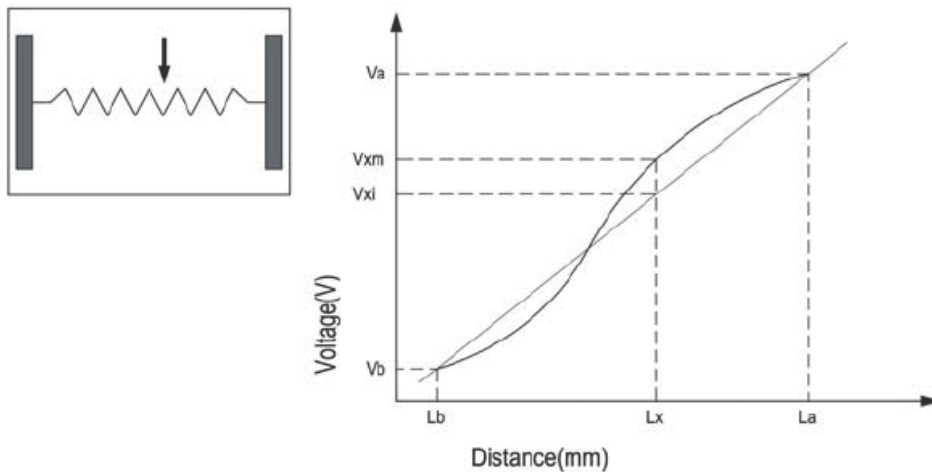

$$\text{Linearity: } [ V_{xm} - V_{xi} ] / (V_a - V_b) \times 100\%$$

### (2) Specification

Linearity must meet the electrical characteristics specified in item 6.

|             |                       |        |
|-------------|-----------------------|--------|
| Product No. | DTS416-1210-0F Series | REV. A |
|-------------|-----------------------|--------|

|      |        |
|------|--------|
| Page | 8 / 11 |
|------|--------|



## 9 APPEARANCE INSPECTION

(1) A 17W fluorescent luminant lamp is used for appearance inspection. Detail settings are shown in notes 9.1 & 9.2.

Note 9.1:

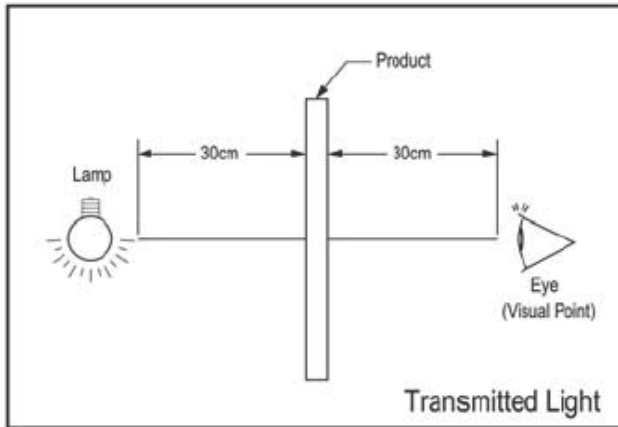

Note 9.2:

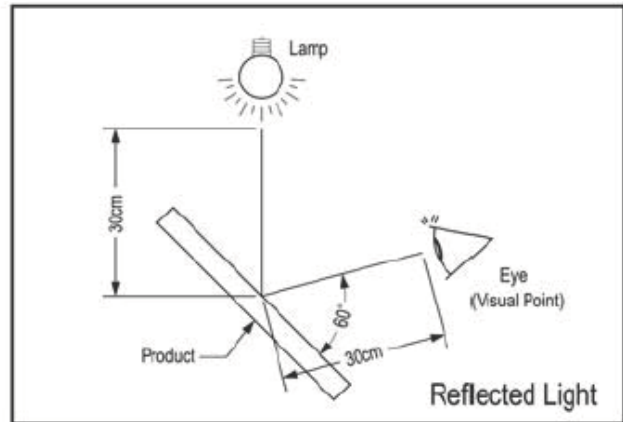

(2) Minor impurities outside viewing area are acceptable unless their existence affect electrical functions.

(3) Glass Flaw:

| Item             | Picture | Specification  |
|------------------|---------|--|
| Corner Flaw      |         | $X \leq 3.0 \text{ mm}$<br>$Y \leq 3.0 \text{ mm}$<br>$Z \leq T$ |
| Edge Flaw        |         | $X \leq 3.0 \text{ mm}$<br>$Y \leq 3.0 \text{ mm}$<br>$Z \leq T$ |
| Progressive Flaw |         | Not allowed  |

Note: T = Glass thickness

**10 ATTENTION FOR MOUNTING**

(1) The gasket support of touch panel must allocate outside of viewable area. Reserve enough clearance between panel surface and enclosure for normal panel operation.

To avoid pressing error, please retain enough space between surface panel and Bezel.

(2) Bezel opening must not touch Viewable Area, Bezel opening must be designed between Viewable Area and Active Area.

(3) We recommend elastic material support.

(4) Due to the conductive characteristic of the panel backside, prevent metal contact after mounting.

(5) Proper grounding of controller at all times assure normal operation.

Note 10.1:

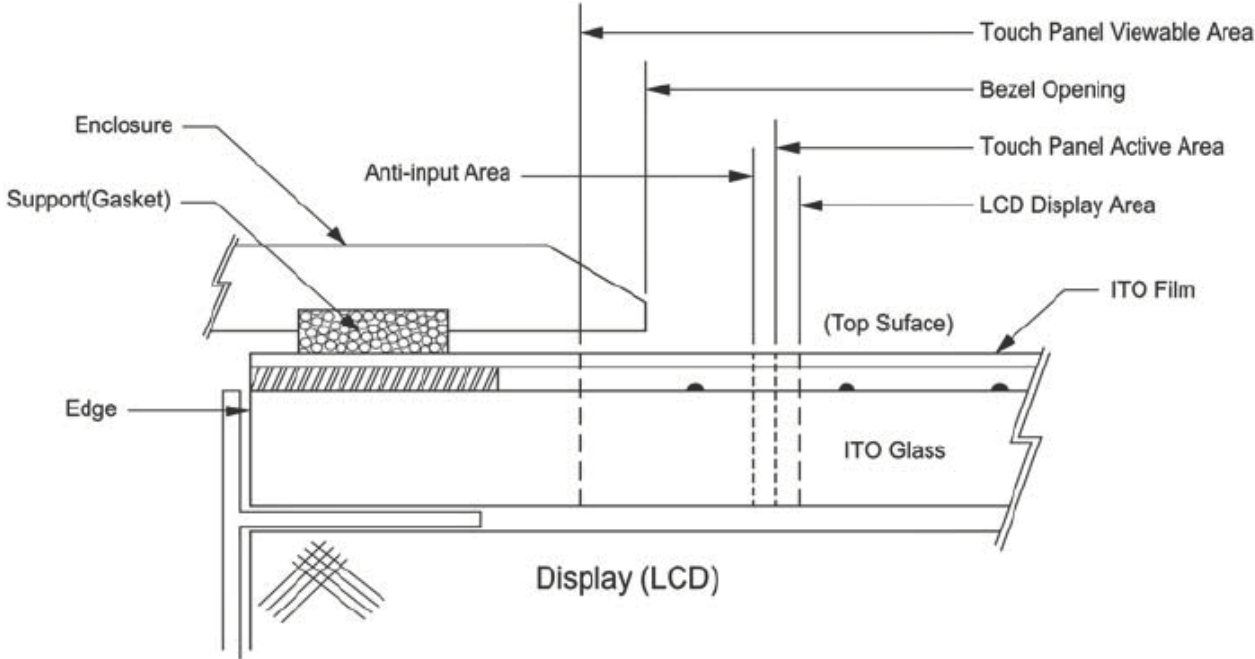

**11 PART NUMBER DESCRIPTION FOR AVAILABLE OPTIONS**

**DTS416-1210-0F①-000**

① **Surface Treatment Type**  
 X= Clear  
 G = Antiglare Finish

**12 HANDLING PRECAUTIONS**

|                           |   |
|---------------------------|---|
| Storage                   | Store panel under the temperature and humidity range pre-specified. Direct sunlight exposure or piling should be avoided.   |
| Unpack                    | Unpack the box with the printed red arrow pointing up.  |
| Handling                  | (1) Use clean sacks or glove to prevent fingerprints and/or stains left on the panel. Extra attention and carefulness should be taken while handling the glass edge.<br>(2) Avoid touching the viewing area before installation /integration.<br>(3) Holding the panel instead of the tail at all time. |
| Cleaning                  | (1) Use neutral detergent or isopropyl alcohol on a clean soft cloth to clean the panel surface.<br>(2) Prevent using any kind of chemical solvent, acidic or alkali solution.  |
| Installing and Assembling | (1) Excessive force or strain to the panel or tail is prohibited.<br>(2) Retain at least 0.3 mm clearance between panel and display module.<br>(3) Gasket or cushion pads around the edge of the panel may segregate water and/or dust contamination.   |
| Operating                 | (1) Touch the panel with your finger or stylus only to assure normal operation. Any sharp edged or hard objects are prohibited.<br>(2) Operate the panel in a steady environment. Abrupt variation on temperature and humidity may cause malfunction of the panel.                                      |
| Others                    | (1) Keep the panel surface clean. Prevent any kind of adhesive applied on the surface.<br>(2) Avoid high voltage and/or static charge.  |