

LIQUID CRYSTAL DISPLAY MODULE

Product Specification

PRODUCT NUMBER	LMR4053
-----------------------	----------------

INTERNAL APPROVALS		
Product Manager	Engineering	Document Control
Date:	Date:	Date:

TABLE OF CONTENTS

1	GENERAL SPECIFICATIONS	4
2	FEATURES	4
3	MECHANICAL DRAWING	5
3.1	WITH WHITE LED B/L	5
3.2	WITH YELLOW-GREEN LED B/L.....	6
4	ABSOLUTE MAXIMUM RATINGS	7
5	ELECTRONIC CHARACTERISTICS	7
5.1	DC CHARACTERISTICS	7
5.2	LCD CURRENT CONSUMPTION & DRIVING VOLTAGE.....	7
6	OPTOELECTRONIC CHARACTERISTICS	8
7	EDGE LED BACKLIGHT ELECTRICAL CHARACTERISTICS	10
7.1	WHITE LED B/L.....	10
7.2	YELLOW-GREEN LED B/L.....	11
8	RELIABILITY TEST	12
8.1	RELIABILITY CHARACTERISTICS (WIDE TEMP.).....	12
8.2	MTBF OF LIQUID CRYSTAL PANEL.....	12
9	OPERATING INSTRUCTIONS	13
9.1	I/O PIN FUNCTION (EDGE LED B/L).....	13
9.2	AC CHARACTERISTICS	14
9.3	CHARACTER FONT.....	16
10	POWER SUPPLY	17
11	BLOCK DIAGRAM	18
12	PART NUMBER DESCRIPTION FOR AVAILABLE OPTIONS	19
13	QUALITY ASSURANCE SPECIFICATION	20
13.1	CONFORMITY.....	20
13.2	DELIVERY ASSURANCE	20
14	HANDLING PRECAUTIONS	24

REVISION RECORD

Rev.	Date	Page	Par.	Comment	ECN no.
A	04/16/09	--	--	Initial DCA Release	E4055
B	7/23/09	--	--	Added 3V/5V and White LED version.	E4147
C	12/13/11	6	--	B/L post added to fix alignment issue.	E4556

1 GENERAL SPECIFICATIONS

ITEM	DESCRIPTION	UNIT
Module Outline Dimensions	96.0 (W) x 22.0 (H) x 7.8 Max (D) (5V White B/L) 96.0 (W) x 22.0 (H) x 8.6 Max (D) (3V White B/L) 89.0 (W) x 24.0 (H) x 7.8 Max (D) (5V Y-G B/L) 89.0 (W) x 24.0 (H) x 8.6 Max (D) (3V Y-G B/L) (Not Including Cable)	mm
Viewing Area	75.0 (W) x 15.0 (H)	mm
Active Display Area	68.5 (W) x 10.7 (H)	mm
LCM Configuration	20 Characters x 2 Lines	--
Character Dimensions	2.95 (W) x 5.15 (H)	mm
Character Pitch	3.45 (W) x 5.55 (H)	mm
LCD Type	STN or FSTN	--
Backlight Type	Edge LED / Yellow-Green or white	--
Duty Ratio	1/16	--
Bias Drive	1/4	--
Controller / Interface	Sitronix ST7066 / Parallel interface	--
Power Supply	Vdd (+5) or Vdd(+3V)	V
RoHS Complaint	Yes	--

2 FEATURES

- With high transparency LCD.

3.2 WITH YELLOW-GREEN LED B/L

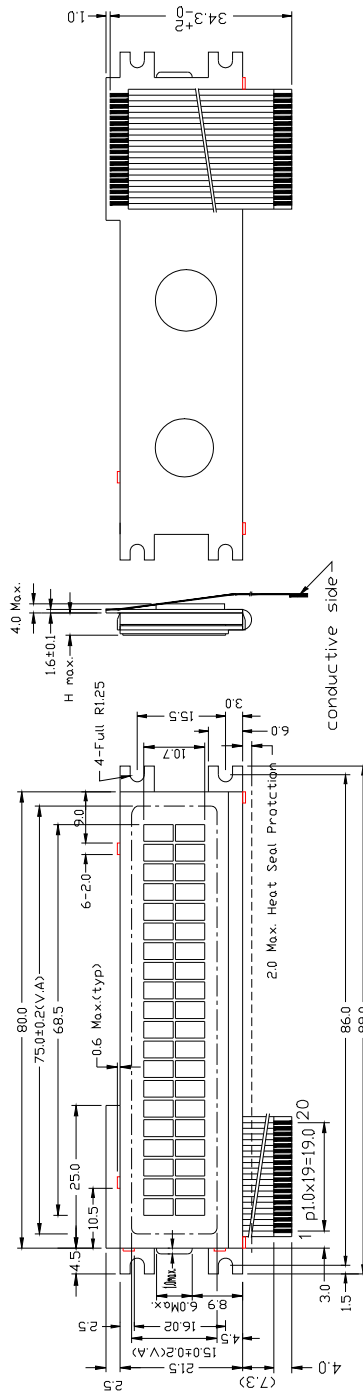

MODULE	H
TRANSFLCTIVE WITHOUT B/L	2.0
LED EDGE	4.6

General tolerance ±0.3 , UNIT:mm

4 ABSOLUTE MAXIMUM RATINGS

Item	Symbol	Conditions	Min.	Max.	Unit
Power Supply Voltage	Vdd	Ta = 25°C, 50 ± 10% RH	0	7.0	V
Operating Temperature	Topr	< 65% RH (Wide Temp.)	-20	70	°C
Storage Temperature	Tstg	< 65% RH (Wide Temp.)	-30	80	°C
		< 48 hrs	20	90	% RH
		< 1000 hrs	20	65	% RH

5 ELECTRONIC CHARACTERISTICS

5.1 DC CHARACTERISTICS

(Vss = 0 V, Ta = 25°C)

Item		Symbol	Conditions	Min.	Typ.	Max.	Unit
Operating Voltage (5V)		Vdd	--	4.75	--	5.25	V
Operating Voltage (3V)		Vdd		2.7	--	4.5	V
Input Voltage	High	Vihc		0.7Vdd	--	Vdd	V
	Low	Vilc		0	--	0.6	
LCD Driving Voltage		Vdd - Vo		3.0	--	10.0	V

5.2 LCD CURRENT CONSUMPTION & DRIVING VOLTAGE

(Vdd - Vss = 5.0 V)

		STN TEMPERATURE	
		Normal Temp.	Wide Temp.
Supply Current, (Idd) Typ., mA		N/A	6
Supply Current, (Iee) Typ., mA		N/A	N/A
Recommended LCD Driving voltage			
LCD Driving Voltage (Vdd - Vo)	Ta = -20 °C	N/A	4.5
	Ta = 0 °C	N/A	4.5
	Ta = 25 °C	N/A	4.5
	Ta = 50 °C	N/A	4.5
	Ta = 70 °C	N/A	4.5

6 OPTOELECTRONIC CHARACTERISTICS

(Ta = 25°C)

Item	Symbol	Conditions	Min.	Typ.	Max.	Unit	Note
Viewing Angle	θ1 (down)	CR ≥ 2	--	45	--	deg.	6.1
	θ2 (up)	CR ≥ 2	--	30	--	deg.	6.1
	θ3 (right)	CR ≥ 2	--	30	--	deg.	6.2
	θ4 (left)	CR ≥ 2	--	30	--	deg.	6.2
Contrast Ratio	CR	Ta = 25°C	2	4	--	--	6.3
Response Time	Tr	Ta = 25°C	--	170	300	ms	6.4
	Tf	Ta = 25°C	--	165	300		
Viewing Direction	6 O'clock						

Note 6.1: Definition of Viewing angle, θ1 & θ2 Note 6.2: Definition of Viewing angle, θ3 & θ4

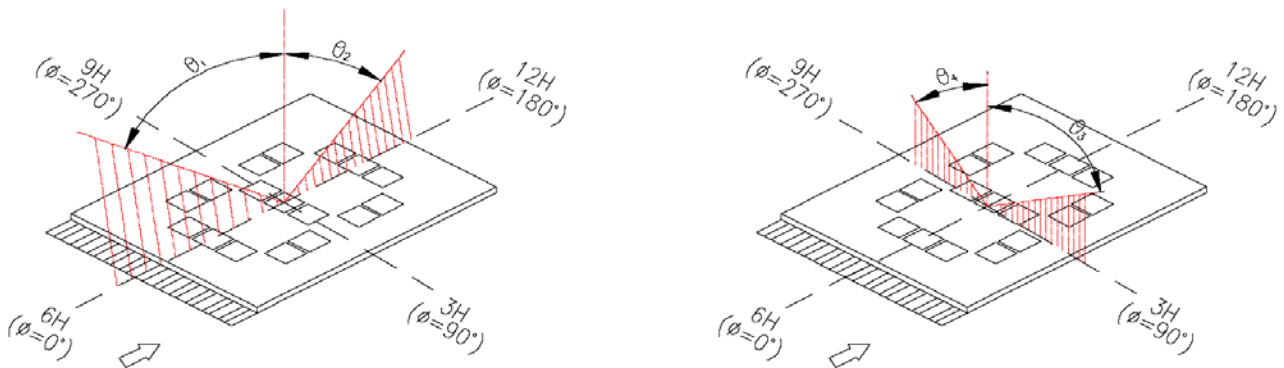

Note 6.3: Definition of Contrast Ratio (CR)

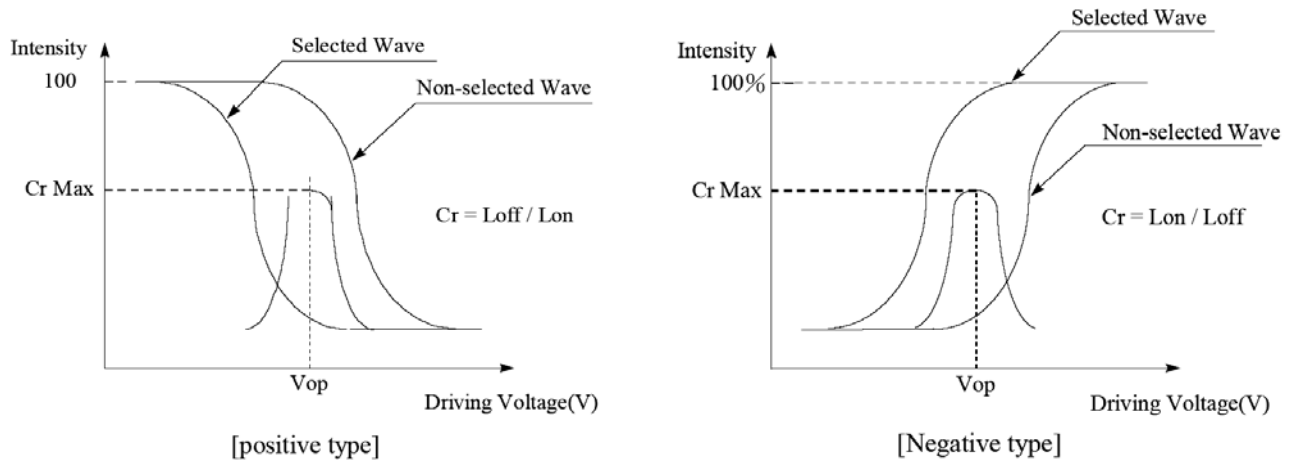

Note 6.4: Definition of Response Time

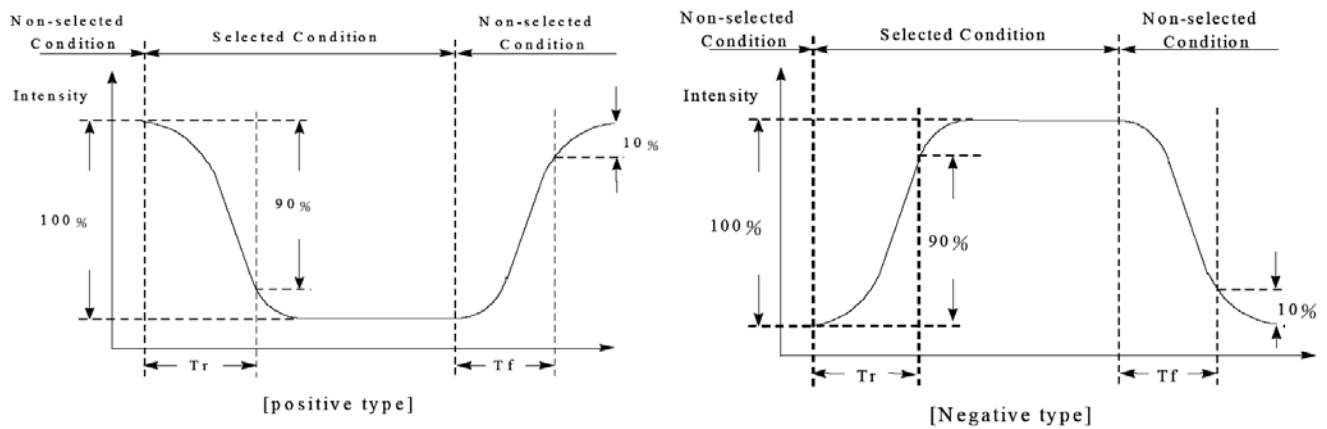

7 EDGE LED BACKLIGHT ELECTRICAL CHARACTERISTICS

7.1 WHITE LED B/L

Item	Conditions	Standard			Unit
		Min.	Typ.	Max.	
Input voltage	T _a = 25 °C	---	3.3	---	V(DC)
Current consumption	T _a = 25 °C		30	40	mA
Average brightness (B/L only) (T _a = 25 °C , I _L = 30 mA)	Test when connecting after 3 min. T _a = 25 °C (max. contrast)				cd/m ² (Note 3)
	White B/L	300	---	---	
Color chromaticity (T _a = 25 °C , I _L = 30 mA)	X	0.26	---	0.33	
	Y	0.26	---	0.33	
Brightness uniformity	T _a = 25 °C , I _L = 30 mA	75	---	---	% (Note 4)
Lamp life	T _a = 25 °C , I _L = 30 mA Humidity : 30%RH ~ 85%RH	---	50,000	---	Hrs (Note 5)
Operating Temp.	Humidity : 30%RH ~ 85%RH	-20	---	70	°C
Storage Temp.	Humidity : 30%RH ~ 85%RH	-30	---	80	°C
limit resistor (R2)	T _a = 25 °C	---	0	---	OHM (Note 1)

Note :

1: R2:Built-in BL current limit resistor at customer board .

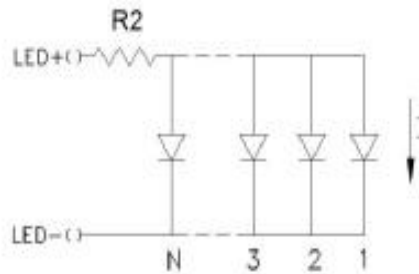

$$N = 2 , I = 10 \text{ mA}$$

3 : Average brightness of 3 points when B/L is used at the beginning.

4 : Brightness uniformity = (MIN / MAX) x 100 %

5 : Half of the original average brightness

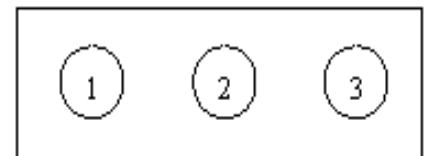

7.2 YELLOW-GREEN LED B/L

Item	Conditions	Min.	Typ.	Max.	Unit
Input voltage	Ta = 25°C	--	5.0	--	V (DC)
Current consumption	Ta = 25°C	--	40	--	mA
Average brightness (B/L only)(Ta = 25°C, IL = 40 mA)	Test when connected for 3 min., Ta = 25 °C				cd/m ² (Note 7.1)
	Yellow-Green Array LED B/L	20	--	--	
Peak Emission Wavelength	Ta = 25°C , IL = 40 mA	570	--	575	nm
Brightness uniformity	Ta = 25°C , IL = 40 mA	75	--	--	% (Note 7.2)
Lamp life	Ta = 25°C , IL = 40 mA Humidity: 30% RH ~ 85% RH	--	50,000	--	Hrs (Note 7.3)
Operating Temp.	Humidity: 30% RH ~ 85% RH	-20	--	70	°C
Storage Temp.	Humidity: 30% RH ~ 85% RH	-30	--	80	°C
Limit Resistor (R1)	Ta = 25°C	--	75	--	Ohm (Note 7.4)

Note 7.1: Average brightness of 3 points when B/L is used at the beginning.

Note 7.2: Brightness uniformity = (MIN / MAX) x 100 %.

Note 7.3: Half of the original average brightness.



Note 7.4: The limit resistor R2 of LED Backlight is built-in to the LED board.

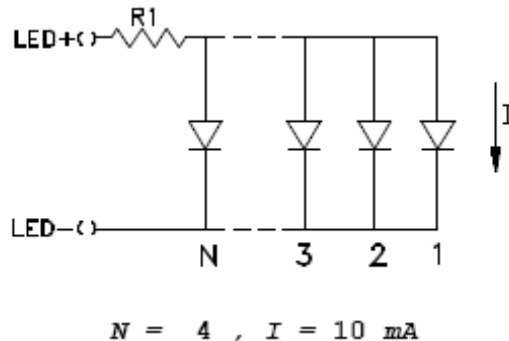

8 RELIABILITY TEST

8.1 RELIABILITY CHARACTERISTICS (WIDE TEMP.)

Test Item	Test Condition	Remarks
High Temperature Operation	240 HR , 70°C ± 2°C	No abnormalities in function and appearance
Low Temperature Operation	240 HR , -20°C ± 2°C	No abnormalities in function and appearance
Thermal Shock Storage (NO operation state)	-30 °C (30 min.) → 25 °C (5 min.) → 80 °C (30 min.) → 25 °C (5 min.) 5 cycles	No abnormalities in function and appearance
Vibration (No operation state)	10 Hz ~ 55 Hz 0.3 mm / 1 Octave 55 Hz ~ 500 Hz 3g / 1 Octave 20 cycles per axis	No abnormalities in function and appearance

8.2 MTBF OF LIQUID CRYSTAL PANEL

50,000 hours, 90% Confidence Level at 25 °C and 65% RH Max.

If any of the following occurs after the MTBF test, the LCD is deemed to be failed:

- Current consumption increases three times the initial value.
- Damaged glass, plug and/or polarizer of the LCD.
- Non-operational display.

9 OPERATING INSTRUCTIONS

9.1 I/O PIN FUNCTION (EDGE LED B/L)

5V VERSION

Pin No.	Function	Level	Description
1	NC	-	No connection
2	NC	-	No connection
3	VSS	-	Ground (0V)
4	VDD	-	Logic Supply Voltage (+5V)
5	Vo	-	Voltage Level for LCD Control Adjustment
6	RS	I	Register Select 0: Instruction Register 1: Data Register
7	R/W	I	Read / Write 0: Data Write (Module-MPU) 1: Data Read (Module-MPU)
8	E	I	Enable Signal Active High (H - L)
9 ~ 16	DB0 ~ 7	I/O	Bi-directional data bus line 0 ~ 7
17	LED(+)		Anode of LED B/L
18	LED(-)		Cathode of LED B/L
19	NC	-	No connection
20	NC	-	No connection

3V VERSION

Pin No.	Function	Level	Description
1	NC	-	No connection
2	NC	-	No connection
	Vss	-	Ground (0V)
4	Vdd	-	Logic Supply Voltage (+3V)
5	Vo	-	Voltage Level for LCD Control Adjustment
6	RS	I	Register Select 0: Instruction Register 1: Data Register
7	R/W	I	Read / Write 0: Data Write (Module-MPU) 1: Data Read (Module-MPU)
8	E	I	Enable Signal Active High (H - L)
9 ~ 16	DB0 ~ 7	I/O	Bi-directional data bus line 0 ~ 7
17	LED(+)	-	Anode of LED B/L
18	LED(-)	-	Cathode of LED B/L
19	Vee	-	Power Supply for LCD Drive
20	NC	-	No connection

9.2 AC CHARACTERISTICS

ST7066U

■ AC Characteristics

(TA = 25°C, VCC = 5V)

Symbol	Characteristics	Test Condition	Min.	Typ.	Max.	Unit
<i>Internal Clock Operation</i>						
f _{OSC}	OSC Frequency	R = 91KΩ	190	270	350	KHz
<i>External Clock Operation</i>						
f _{EX}	External Frequency	-	125	270	410	KHz
	Duty Cycle	-	45	50	55	%
T _R , T _F	Rise/Fall Time	-	-	-	0.2	μs
<i>Write Mode (Writing data from MPU to ST7066U)</i>						
T _C	Enable Cycle Time	Pin E	1200	-	-	ns
T _{PW}	Enable Pulse Width	Pin E	140	-	-	ns
T _R , T _F	Enable Rise/Fall Time	Pin E	-	-	25	ns
T _{AS}	Address Setup Time	Pins: RS, RW, E	0	-	-	ns
T _{AH}	Address Hold Time	Pins: RS, RW, E	10	-	-	ns
T _{DSW}	Data Setup Time	Pins: DB0 - DB7	40	-	-	ns
T _H	Data Hold Time	Pins: DB0 - DB7	10	-	-	ns
<i>Read Mode (Reading Data from ST7066U to MPU)</i>						
T _C	Enable Cycle Time	Pin E	1200	-	-	ns
T _{PW}	Enable Pulse Width	Pin E	140	-	-	ns
T _R , T _F	Enable Rise/Fall Time	Pin E	-	-	25	ns
T _{AS}	Address Setup Time	Pins: RS, RW, E	0	-	-	ns
T _{AH}	Address Hold Time	Pins: RS, RW, E	10	-	-	ns
T _{DDR}	Data Setup Time	Pins: DB0 - DB7	-	-	100	ns
T _H	Data Hold Time	Pins: DB0 - DB7	10	-	-	ns
<i>Interface Mode with LCD Driver(ST7065)</i>						
T _{CWH}	Clock Pulse with High	Pins: CL1, CL2	800	-	-	ns
T _{CWL}	Clock Pulse with Low	Pins: CL1, CL2	800	-	-	ns
T _{CST}	Clock Setup Time	Pins: CL1, CL2	500	-	-	ns
T _{SU}	Data Setup Time	Pin: D	300	-	-	ns
T _{CH}	Data Hold Time	Pin: D	300	-	-	ns
T _{DM}	M Delay Time	Pin: M	0	-	2000	ns

ST7066U

■ Timing Characteristics

● Writing data from MPU to ST7066U

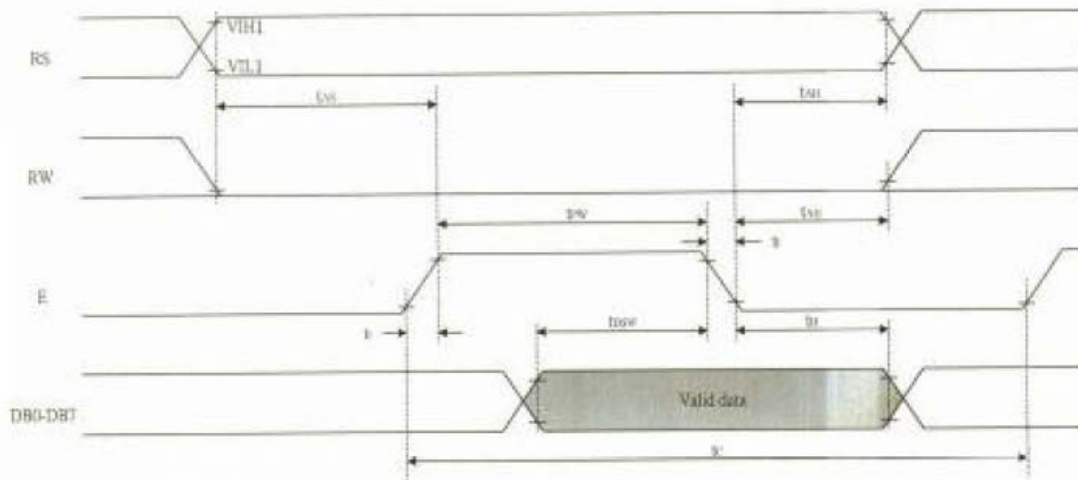

● Reading data from ST7066U to MPU

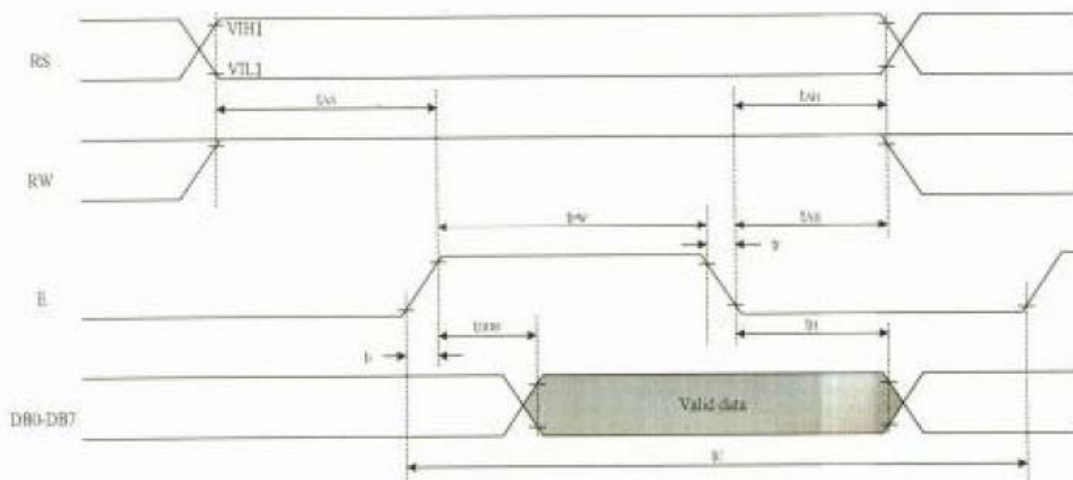

9.3 CHARACTER FONT

NO.7066-0A

b7-b4 b3-b0	0000	0001	0010	0011	0100	0101	0110	0111	1000	1001	1010	1011	1100	1101	1110	1111
0000	CG RAM (1)			0	1	2	3	4			5	6	7	8	9	A
0001	(2)	!	1	A	Q	a	q				2	3	4	5	6	7
0010	(3)	"	2	B	R	b	r				7	8	9	0	1	2
0011	(4)	#	3	C	S	c	s				0	1	2	3	4	5
0100	(5)	\$	4	D	T	d	t				1	2	3	4	5	6
0101	(6)	%	5	E	U	e	u				2	3	4	5	6	7
0110	(7)	&	6	F	V	f	v				3	4	5	6	7	8
0111	(8)	'	7	G	W	g	w				4	5	6	7	8	9
1000	(1)	(8	H	X	h	x				5	6	7	8	9	0
1001	(2))	9	I	Y	i	y				6	7	8	9	0	1
1010	(3)	*	:	J	Z	j	z				7	8	9	0	1	2
1011	(4)	+	;	K	[k	[8	9	0	1	2	3
1100	(5)	,	<	L]	l]				9	0	1	2	3	4
1101	(6)	-	=	M	^	m	^				0	1	2	3	4	5
1110	(7)	.	>	N	~	n	~				1	2	3	4	5	6
1111	(8)	/	?	O	_	o	_				2	3	4	5	6	7

10 POWER SUPPLY

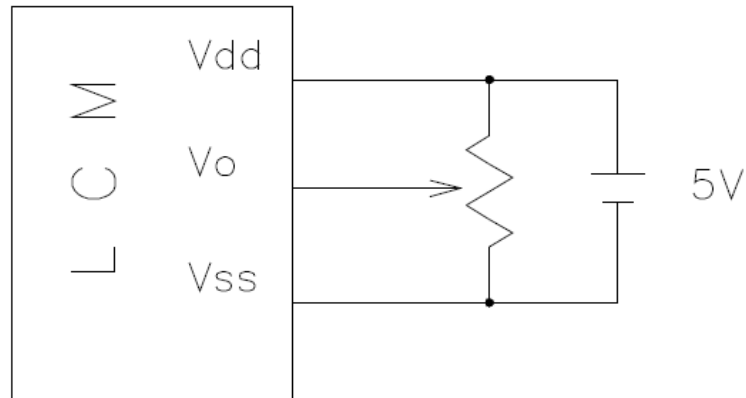
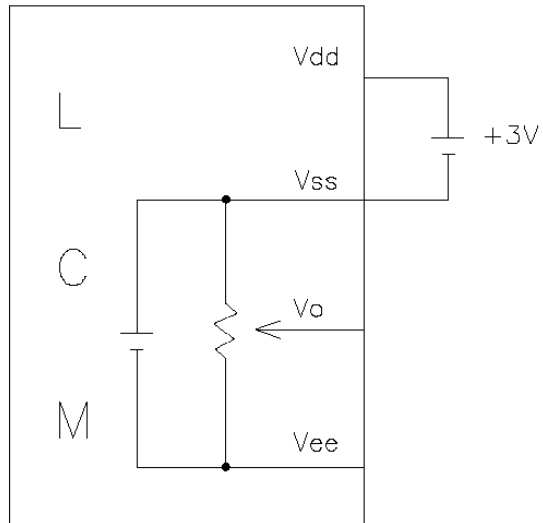

RECOMMENDED V_R : 10K ohm ~ 20K ohm

11 BLOCK DIAGRAM

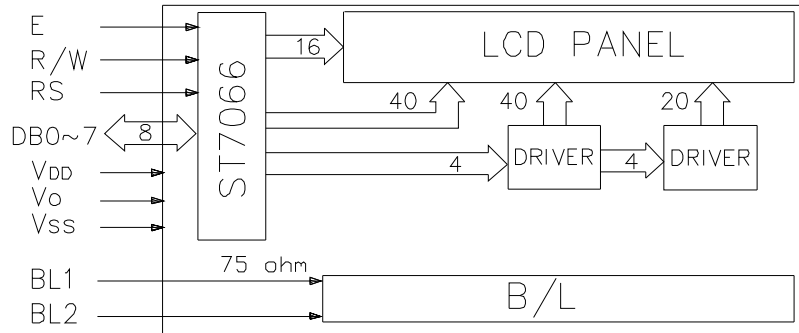

12 PART NUMBER DESCRIPTION FOR AVAILABLE OPTIONS

LMR4053①②2C20③④⑤

①

Polarizer Type

B = Transflective Positive Mode

②

Backlight Color

G = Yellow-Green

W= White

③

Fluid Type and Temperature Range

H =Extended temp. Negative supply voltage required.

W= Extended temp. On board negative supply voltage.

④

Fluid Type and Temperature Compensation

N = STN

F = FSTN

⑤

Background Color

G = Gray mode STN

13 QUALITY ASSURANCE SPECIFICATION

13.1 CONFORMITY

The performance, function and reliability of the shipped products conform to the Product Specification.

13.2 DELIVERY ASSURANCE

11.2.1 Delivery Inspection Standards

- IPC-AA610, Class 2 Electronic assemblies' standard.

The Quality assurance levels are shown below:

Rank	Item Inspected	Defect type	AQL	Remark		
Major defect	Display	No display	0.25%	Fit/Function defect		
		Over current				
		Missing segment				
		Wrong Viewing direction				
		Incorrect operation				
		No Backlight				
	Flickering Backlight					
	Dimensions	PCB and/or Bezel out of Specifications				
Minor defect	LCD	Black and White spots	1.0%	Appearance defect		
		Black and White lines				
		Polarizer Scratches				
		Bubbles in Polarizer				
		Segment deformations, Pin holes				
		Color Defect				
	COB	Glass Chips				
		Wire Bonding Pad exposed				
		Insufficient covering with Resin (Wire Bonding line exposed)				
	PCB	Bubbles or Dust on COB				
		Dust or Solder balls on PCB				
	Tray	Pad Scratches				
Particles			Every Tray			
Total			1.0%			

11.2.2 Zone Definition

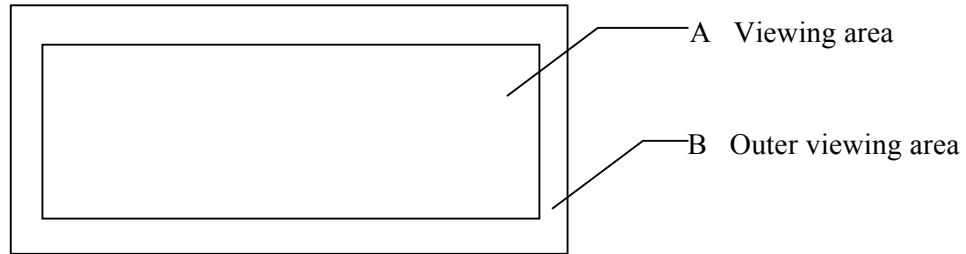

11.2.3 Visual Inspection

- ❖ Inspect under 2 x 20 W or one 40 W fluorescent lamp (approximately 3000 lux.) leaving 25 to 30 cm between the module and the lamp and 30 cm between the module and the eye. (Measuring position).
- ❖ Appearance is inspected at the best contrast voltage (best contrast is adjusted by considering clarity and crosstalk on the screen).
- ❖ Inspect the module at 45° right and left, top and bottom.
- ❖ Use the optimum viewing angle during the contrast inspection.

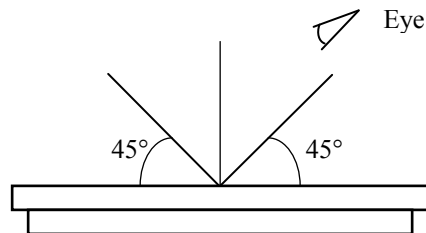

11.2.3.1 Standard of Appearance Inspection

Unit: mm

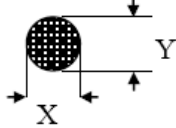
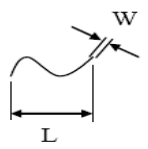
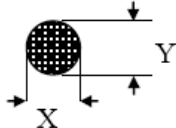
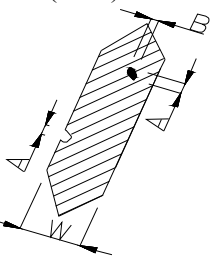
No.	Item	Criteria																															
1	Black spot, White spot, Dust	<p>Round type as shown: $\Phi = (X+Y)/2$</p>  <table border="1" style="margin-left: 200px;"> <thead> <tr> <th colspan="3">Acceptable quantity</th> </tr> <tr> <th>Size</th> <th>Zone A</th> <th>Zone B</th> </tr> </thead> <tbody> <tr> <td>$\Phi < 0.2$</td> <td>Any number</td> <td rowspan="3">Any number</td> </tr> <tr> <td>$0.2 < \Phi < 0.25$</td> <td>2</td> </tr> <tr> <td>$0.25 < \Phi$</td> <td>0</td> </tr> </tbody> </table> <p>Line type as shown:</p>  <table border="1" style="margin-left: 200px;"> <thead> <tr> <th colspan="4">Acceptable quantity</th> </tr> <tr> <th>Length</th> <th>Width</th> <th>Zone A</th> <th>Zone B</th> </tr> </thead> <tbody> <tr> <td>-</td> <td>$W \leq 0.03$</td> <td>Any number</td> <td rowspan="3">Any number</td> </tr> <tr> <td>$L \leq 3$</td> <td>$0.03 < W \leq 0.05$</td> <td>2</td> </tr> <tr> <td>-</td> <td>$0.05 < W$</td> <td>As round type</td> </tr> </tbody> </table> <p>Total acceptable quantity: 5</p>	Acceptable quantity			Size	Zone A	Zone B	$\Phi < 0.2$	Any number	Any number	$0.2 < \Phi < 0.25$	2	$0.25 < \Phi$	0	Acceptable quantity				Length	Width	Zone A	Zone B	-	$W \leq 0.03$	Any number	Any number	$L \leq 3$	$0.03 < W \leq 0.05$	2	-	$0.05 < W$	As round type
Acceptable quantity																																	
Size	Zone A	Zone B																															
$\Phi < 0.2$	Any number	Any number																															
$0.2 < \Phi < 0.25$	2																																
$0.25 < \Phi$	0																																
Acceptable quantity																																	
Length	Width	Zone A	Zone B																														
-	$W \leq 0.03$	Any number	Any number																														
$L \leq 3$	$0.03 < W \leq 0.05$	2																															
-	$0.05 < W$	As round type																															
2	Polarizer Scratch	Scratch on Protective film is permitted. Scratch on Polarizer: Same as 1.																															
3	Polarizer Bubble	<p>$\Phi = (X+Y)/2$</p>  <table border="1" style="margin-left: 200px;"> <thead> <tr> <th colspan="3">Acceptable quantity</th> </tr> <tr> <th>Size</th> <th>Zone A</th> <th>Zone B</th> </tr> </thead> <tbody> <tr> <td>$\Phi < 0.2$</td> <td>Any number</td> <td rowspan="4">Any number</td> </tr> <tr> <td>$0.2 < \Phi < 0.5$</td> <td>3</td> </tr> <tr> <td>$0.5 < \Phi < 1.0$</td> <td>1</td> </tr> <tr> <td>$1.0 < \Phi$</td> <td>0</td> </tr> </tbody> </table> <p>Total acceptable quantity: 4</p>	Acceptable quantity			Size	Zone A	Zone B	$\Phi < 0.2$	Any number	Any number	$0.2 < \Phi < 0.5$	3	$0.5 < \Phi < 1.0$	1	$1.0 < \Phi$	0																
Acceptable quantity																																	
Size	Zone A	Zone B																															
$\Phi < 0.2$	Any number	Any number																															
$0.2 < \Phi < 0.5$	3																																
$0.5 < \Phi < 1.0$	1																																
$1.0 < \Phi$	0																																
4	Segment Deformation	<p>I.a. Pin hole on segmented display:</p> <p>W: Segment Width</p> <p>$\Phi = (A+B)/2$</p>  <table border="1" style="margin-left: 200px;"> <thead> <tr> <th colspan="2">Acceptable quantity</th> </tr> <tr> <th>Width</th> <th>Φ</th> </tr> </thead> <tbody> <tr> <td>$W \leq 0.4$</td> <td>$\Phi \leq 0.2$ and $\Phi \leq \frac{1}{2}W$</td> </tr> <tr> <td>$W > 0.4$</td> <td>$\Phi \leq 0.25$ and $\Phi \leq (1/3)W$</td> </tr> </tbody> </table> <p>Total acceptable quantity: 1 Defect per segment. Pin holes with Φ under 0.10 mm are acceptable.</p>	Acceptable quantity		Width	Φ	$W \leq 0.4$	$\Phi \leq 0.2$ and $\Phi \leq \frac{1}{2}W$	$W > 0.4$	$\Phi \leq 0.25$ and $\Phi \leq (1/3)W$																							
Acceptable quantity																																	
Width	Φ																																
$W \leq 0.4$	$\Phi \leq 0.2$ and $\Phi \leq \frac{1}{2}W$																																
$W > 0.4$	$\Phi \leq 0.25$ and $\Phi \leq (1/3)W$																																

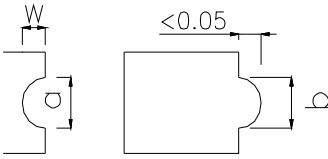
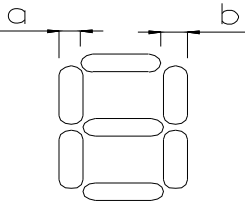
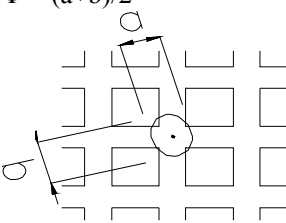
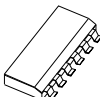
No.	Item	Criteria																												
4	Segment Deformation	<p>1.b. Pin hole on dot matrix display:</p>  <table border="1" data-bbox="876 325 1307 493"> <thead> <tr> <th colspan="2">Acceptable quantity</th> </tr> </thead> <tbody> <tr> <td>Size</td> <td>-</td> </tr> <tr> <td>$a, b < 0.1$</td> <td>Any number</td> </tr> <tr> <td>$(a+b)/2 \leq 0.1$</td> <td>Any number</td> </tr> <tr> <td>$0.5 < \Phi < 1.0$</td> <td>3</td> </tr> </tbody> </table> <p>Total acceptable quantity: 7</p> <p>2. Segments / dots with different width:</p>  <table border="1" data-bbox="876 703 1307 808"> <thead> <tr> <th colspan="2">Acceptable limits</th> </tr> </thead> <tbody> <tr> <td>$a \geq b$</td> <td>$a/b \leq 4/3$</td> </tr> <tr> <td>$a < b$</td> <td>$a/b > 4/3$</td> </tr> </tbody> </table> <p>3. Alignment layer defect:</p> <p>$\Phi = (a+b)/2$</p>  <table border="1" data-bbox="876 955 1307 1155"> <thead> <tr> <th colspan="2">Acceptable quantity</th> </tr> </thead> <tbody> <tr> <td>Size</td> <td>-</td> </tr> <tr> <td>$\Phi \leq 0.4$</td> <td>Any number</td> </tr> <tr> <td>$0.4 < \Phi \leq 1.0$</td> <td>5</td> </tr> <tr> <td>$1.0 < \Phi \leq 1.5$</td> <td>3</td> </tr> <tr> <td>$1.5 < \Phi \leq 2.0$</td> <td>2</td> </tr> </tbody> </table>	Acceptable quantity		Size	-	$a, b < 0.1$	Any number	$(a+b)/2 \leq 0.1$	Any number	$0.5 < \Phi < 1.0$	3	Acceptable limits		$a \geq b$	$a/b \leq 4/3$	$a < b$	$a/b > 4/3$	Acceptable quantity		Size	-	$\Phi \leq 0.4$	Any number	$0.4 < \Phi \leq 1.0$	5	$1.0 < \Phi \leq 1.5$	3	$1.5 < \Phi \leq 2.0$	2
Acceptable quantity																														
Size	-																													
$a, b < 0.1$	Any number																													
$(a+b)/2 \leq 0.1$	Any number																													
$0.5 < \Phi < 1.0$	3																													
Acceptable limits																														
$a \geq b$	$a/b \leq 4/3$																													
$a < b$	$a/b > 4/3$																													
Acceptable quantity																														
Size	-																													
$\Phi \leq 0.4$	Any number																													
$0.4 < \Phi \leq 1.0$	5																													
$1.0 < \Phi \leq 1.5$	3																													
$1.5 < \Phi \leq 2.0$	2																													
5	Color Uniformity	Level of samples for approval is set as the limit.																												
6	Backlight	The backlight color should correspond to the product specification. Flashing / flickering and / or non-functioning backlight is not allowed. Dust larger than 0.25 mm is not allowed.																												
7	COB	Exposed wire bonding pad is not allowed. Insufficient covering with resin is not allowed. (Exposed Wire bonding line) Dust or bubbles on the resin are not allowed.																												
8	 PCB	Non-melted solder paste should not be present on the PCB. Cold solder joints, missing solder connections, or oxidation is not allowed. Residue or solder balls on the PCB are not allowed. Short circuits on components are not allowed.																												

14 HANDLING PRECAUTIONS

Safety

If the LCD panel breaks, be careful not to get the liquid crystal fluid in your mouth or in your eyes.
If the liquid crystal touches your skin or clothes, wash it off immediately using soap and plenty of water.

Mounting and Design

Place a transparent plate (e.g. acrylic, polycarbonate or glass) on the display surface to protect the display from external pressure. Leave a small gap between the transparent plate and the display surface.
When assembling with a zebra connector, clean the surface of the pads with alcohol and keep the surrounding air very clean. Design the system so that no input signal is given unless the power supply voltage is applied.

Caution during LCD cleaning

Lightly wipe the display surface with a soft cloth soaked with Isopropyl alcohol, Ethyl alcohol or Trichlorotrifluoroethane. Do not wipe the display surface with dry or hard materials that will damage the polarizer surface. Do not use aromatic solvents (toluene and xylene), or ketonic solvents (ketone and acetone).

Caution against static charge

As the display uses C-MOS LSI drivers, connect any unused input terminals to VDD or VSS. Do not input any signals before power is turned on. Also, ground your body, work / assembly table and assembly equipment to protect against static electricity.

Packaging

Displays use LCD elements, and must be treated as such. Avoid strong shock and drop from a height.
To prevent displays from degradation, do not operate or store them exposed directly to sunlight or high temperature / humidity.

Caution during operation

It is indispensable to drive the display within the specified voltage limit since excessive voltage shortens its life. Direct current causes an electrochemical reaction with remarkable deterioration of the display quality. Give careful consideration to prevent direct current during ON/OFF timing and during operation.
Response time is extremely delayed at temperatures lower than the operating temperature range while, at high temperatures, displays become dark. However, this phenomenon is reversible and does not mean a malfunction or a display that has been permanently damaged. If the display area is pushed on hard during operation, some graphics will be abnormally displayed but returns to a normal condition after turning off the display once. Even a small amount of condensation on the contact pads (terminals) can cause an electrochemical reaction which causes missing rows and columns. Give careful attention to avoid condensation.

Storage

Store the display in a dark place where the temperature is 25°C ± 10°C and the humidity below 50% RH.
Store the display in a clean environment, free from dust, organic solvents and corrosive gases.
Do not crash, shake or jolt the display (including accessories).

Product No.	LMR4053	REV. C
-------------	---------	--------

Page	24 / 24
------	---------