

OLED DISPLAY MODULE

Product Specification

CUSTOMER	Standard	
PRODUCT NUMBER	DD-2C20YW-2A	
CUSTOMER APPROVAL		Date

INTERNAL APPROVALS		
Product Mgr	Doc. Control	Electr. Eng
Bazile Peter	Bruno Recaldini	Alan Wang
Date: 29 Apr 13	Date: 29 Apr 13	Date: 29 Apr 13

TABLE OF CONTENTS

1	MAIN FEATURES	4
2	MECHANICAL SPECIFICATION	5
2.1	MECHANICAL CHARACTERISTICS	5
2.2	MECHANICAL DRAWING	6
3	ELECTRICAL SPECIFICATION.....	7
3.1	ABSOLUTE MAXIMUM RATINGS	7
3.2	ELECTRICAL CHARACTERISTICS	8
3.3	INTERFACE PIN ASSIGNMENT	9
3.4	BLOCK DIAGRAM	10
3.5	TIMING CHARACTERISTICS	11
4	OPTICAL SPECIFICATION.....	12
4.1	OPTICAL CHARACTERISTICS	12
5	FUNCTIONAL SPECIFICATION	13
5.1	COMMANDS	13
5.2	POWER UP/DOWN SEQUENCE.....	13
5.3	RESET CIRCUIT	13
5.4	ACTUAL APPLICATION EXAMPLE	14
5.5	US2066 CGROM CHARACTER CODE.....	16
6	PACKAGING AND LABELLING SPECIFICATION.....	20
7	QUALITY ASSURANCE SPECIFICATION.....	21
7.1	CONFORMITY	21
7.2	DELIVERY ASSURANCE	21
7.3	DEALING WITH CUSTOMER COMPLAINTS	27
8	RELIABILITY SPECIFICATION	28
8.1	RELIABILITY TESTS	28
8.2	LIFE TIME	28
9	HANDLING PRECAUTIONS.....	29
9.1	HANDLING PRECAUTIONS	29
9.2	STORAGE PRECAUTIONS	30
9.3	DESIGNING PRECAUTIONS.....	30
9.4	OTHER PRECAUTIONS	31
10	SUPPORTED ACCESSORIES	32
10.1	DUO KIT.....	32
10.2	TRANSITION BOARD CARD	32
10.3	CONNECTORS	32
10.4	APPLICATION NOTES AND EXAMPLE CODES	32

Product No.	DD-2C20YW-2A	REV. A

Page	2 / 32
------	--------

REVISION RECORD

Rev.	Date	Page	Chapt.	Comment	ECR no.
A	29 Apr 13			First Issue	

Product No.	DD-2C20YW-2A	REV. A

Page	3 / 32
------	--------

1 MAIN FEATURES

ITEM	CONTENTS
Characters x lines	20 x 2
Character Font	5 x 8
Overall Dimensions	116.0 x 37.0 x 5.8 mm
Colour	Monochrome Yellow
Active Area	73.52 x 11.52 mm
Viewing Area	75.52 x 13.52 mm
Display Mode	Passive Matrix (2.93")
Driving Method	1/16 duty
Driver IC	US2066
Operating temperature	-40 ~ +70
Storage temperature	-40 ~ +85

Product No.	DD-2C20YW-2A	REV. A

Page	4 / 32
------	--------

2 MECHANICAL SPECIFICATION

2.1 MECHANICAL CHARACTERISTICS

ITEM	CHARACTERISTIC	UNIT
Characters x lines	20 x 2	
Overall Dimensions	116.0 x 37.0 x 5.8	mm
Viewing Area	75.52 x 13.52	mm
Active Area	73.52 x 11.52	mm
Dot Size	0.62 x 0.67	mm
Dot Pitch	0.65 x 0.70	mm
Character size	3.22 x 5.57	mm
Weight	25	g
IC Controller/Driver	US2066	

Product No.	DD-2C20YW-2A	REV. A

Page	5 / 32
------	--------

3 ELECTRICAL SPECIFICATION

3.1 ABSOLUTE MAXIMUM RATINGS

VSS = 0 V, Ta = 25 °C

Item	Symbol	Min	Max	Unit	Note
Supply Voltage for logic	V _{DD}	-0.3	6	V	Note 1, 2
Operating Temperature	T _{op}	-40	70	°C	Note 3
Storage Temperature	T _{st}	-40	85	°C	Note 3
Life time (120 cd/m ²)		80,000		Hour	Note 4
Life time (150 cd/m ²)		50,000		Hour	Note 4

Note 1: All the above voltages are on the basis of “VSS=0V”.

Note 2: When this module is used beyond the above absolute maximum ratings, permanent damage to the module may occur. Also for normal operations it's desirable to use this module under the conditions according to Section 3.2 “Electrical Characteristics”. If this module is used beyond these conditions the module may malfunction and the reliability could deteriorate.

Note 3: The defined temperature ranges do not include the polarizer. The maximum withstood temperature of the polarizer should be 80°C.

Note 4: VDD = 5V, Ta = 25°C, 50% Checkerboard.

Software configuration follows section 5.4.

End of lifetime is specified as 50% of initial brightness reached. The average operating lifetime at room temperature is estimated by the accelerated operation at high temperature conditions.

3.2 ELECTRICAL CHARACTERISTICS

Characteristics	Symbol	Conditions	Min	Typ	Max	Unit
Supply Voltage for Display	V_{DD}		4.4	5.0	5.5	V
High Level Input	V_{IH}	$I_{OUT}=0.1mA,$ 3.3MHz -	$0.8 \times V_{DD}$	-	V_{DD}	V
Low Level Input	V_{IL}		0	-	$0.2 \times V_{DD}$	V
High Level Output	V_{OH}		$0.9 \times V_{DD}$	-	V_{DD}	V
Low Level Output	V_{OL}		0	-	$0.1 \times V_{DD}$	V
Operating current for V_{DD}	I_{DD}		Note 5	-	(35)	(45)
		Note 6	-	(50)	(60)	
		Note 7	-	(95)	(115)	
Sleep mode current for V_{DD}	$I_{DD\ SLEEP}$		-	(400)	(600)	μA

Note 5: $V_{DD} = 5.0V$, 30% display area turned on.

Note 6: $V_{DD} = 5.0V$, 50% display area turned on.

Note 7: $V_{DD} = 5.0V$, 100% display area turned on.

Product No.	DD-2C20YW-2A	REV. A

Page	8 / 32
------	--------

3.3 INTERFACE PIN ASSIGNMENT

No.	Symbol	I/O	Function
1	VSS	P	Ground of Logic Circuit This is a ground pin. It also acts as a reference for the logic pins, the OLED driving voltages and the analogue circuits. It must be connected to external ground.
2	VDD	P	Power Supply for Logic It should match with the MCU interface voltage level and must be connected to external source. It will also generate the power supply to the OLED driver through the DC/DC booster on the PCBA.
3	N.C.(GND)	-	Reserved Pin The reserved pin should be left floating
4	D/C#	I	Data/Command Control This is Data/Command control pin. When the pin is pulled high, the input at D7~D0 is treated as display data. When the pin is pulled low, the input at D7~D0 will be transferred to the command register. For detail relationship to MCU interface signals, please refer to the Timing Characteristics Diagrams.
5	R/W#	I	Read/Write Select or Write This pin is MCU interface input. When interfacing to a 68XX-series microprocessor, this pin will be used as Read/Write (R/W#) selection input. Pull this pin to “High” for read mode and pull it to “Low” for write mode.
6	E	I	Read/Write Enable or Read This pin is MCU interface input. When interfacing to a 68XX-series microprocessor, this pin will be used as the Enable (E) signal. Read/write operation is initiated when this pin is pulled high.
7~14	D0~D7	I/O	Host Data Input/Output Bus These pins are 8-bit bi-directional data bus to be connected to the microprocessor’s data bus.
15	N.C.	-	Reserved Pin The reserved pin should be left floating
16	N.C.	-	Reserved Pin The reserved pin should be left floating

Product No.	DD-2C20YW-2A	REV. A

Page	9 / 32
------	--------

3.4 BLOCK DIAGRAM

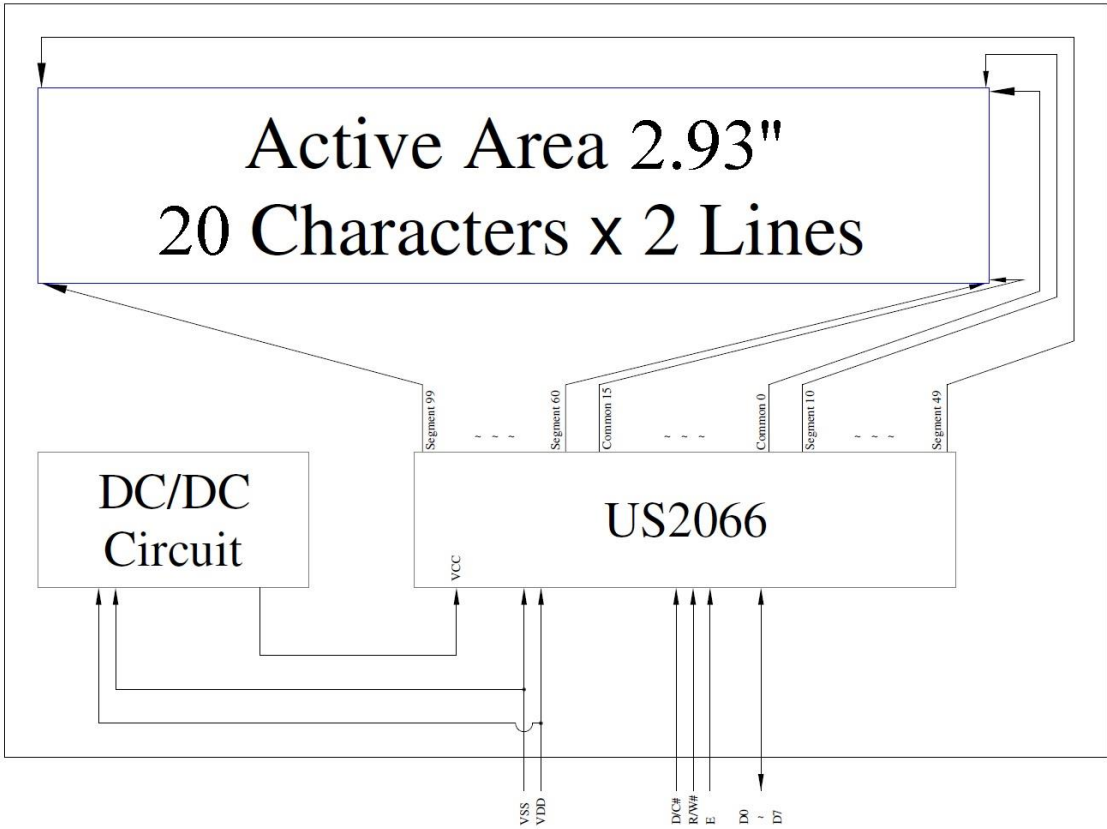

Pins connected to MCU interface: D/C#, R/W#, E#, and D0~D7

Product No.	DD-2C20YW-2A	REV. A

Page	10 / 32
------	---------

3.5 TIMING CHARACTERISTICS

3.5.1 AC CHARACTERISTICS

VDD-VSS = 4.4V to 5.5V, Ta = 25°C

Symbol	Description	Min	Max	Unit
t _{cycle}	System Cycle Time	400	-	ns
t _{AS}	Address Setup Time	13	-	ns
t _{AH}	Address Hold Time	17	-	ns
t _{DSW}	Write Data Setup Time	35	-	ns
t _{DHW}	Write Data Hold Time	18	-	ns
t _{DHR}	Read Data Hold Time	13	-	ns
t _{OH}	Output Disable Time	10	90	ns
t _{ACC}	Access Time (RAM)	-	125	ns
	Access Time (Command)			
PW _{CSL}	Chip Select Low Pulse Width (Read RAM)	250	-	ns
	Chip Select Low Pulse Width (Read Command)	250		
	Chip Select Low Pulse Width (Write)	50		
PW _{CSH}	Chip Select High Pulse Width (Read)	155	-	ns
	Chip Select High Pulse Width (Write)	55		
t _R	Rise Time	-	15	ns
t _F	Fall Time	-	15	ns

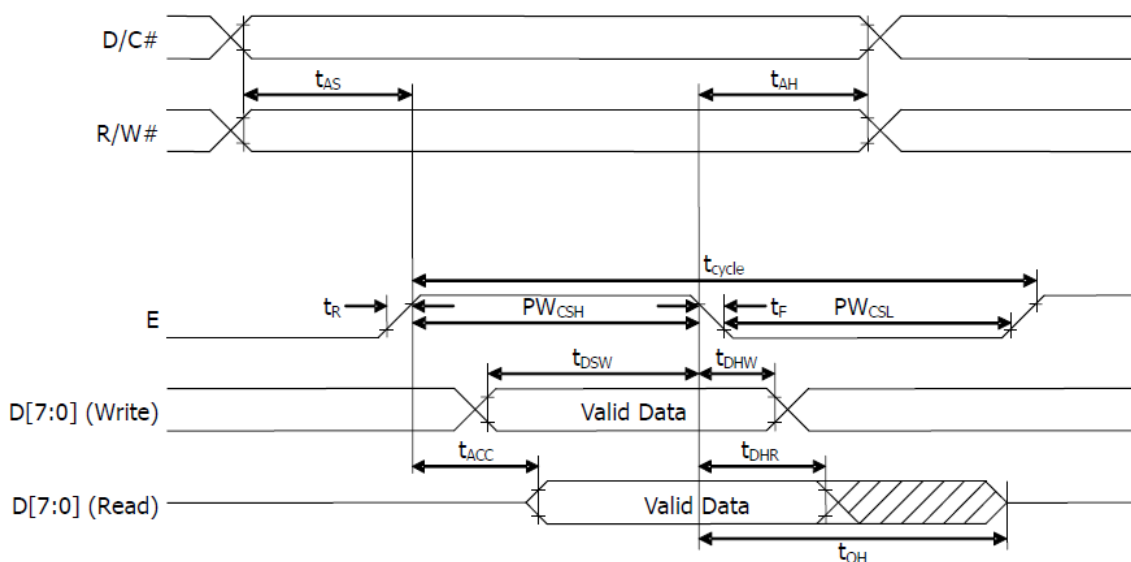

4 OPTICAL SPECIFICATION

4.1 OPTICAL CHARACTERISTICS

Characteristics	Symbol	Condition	Min	Typ	Max	Unit
Brightness	L _{br}	Note 1	100	120	-	cd/m ²
C.I.E.(Yellow)	(X)	C.I.E. 1931	0.46	0.50	0.54	-
	(Y)		0.45	0.49	0.53	
Dark Room Contrast	CR		-	>10,000:1	-	-
Viewing Angle			-	Free	-	degree

Optical measurement taken at V_{DD} = 5.0V
Software configuration follows Section 5.4

Product No.	DD-2C20YW-2A	REV. A

Page	12 / 32
------	---------

5 FUNCTIONAL SPECIFICATION

5.1 COMMANDS

Please refer to the Technical Manual for the US2066

5.2 POWER UP/DOWN SEQUENCE

To protect panel and extend the panel lifetime, the driver IC power up/down routine should include a delay period between high voltage and low voltage power sources during turn on/off. It gives the panel enough time to complete the action of charge and discharge before/after the operation.

5.2.1 POWER UP SEQUENCE

1. Power up V_{DD}
2. Send Display off command
3. Delay 100ms
(when DC/DC booster is stable)
4. Initialisation
5. Clear Screen
6. Send Display on command

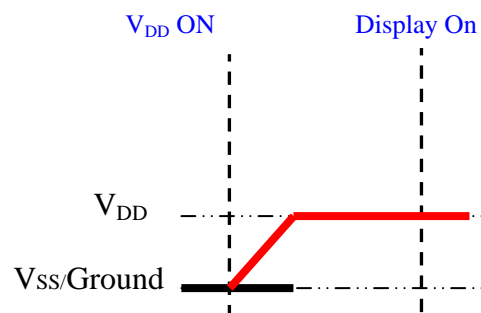

5.2.2 POWER DOWN SEQUENCE

1. Send Display off command
2. Power down V_{DD}

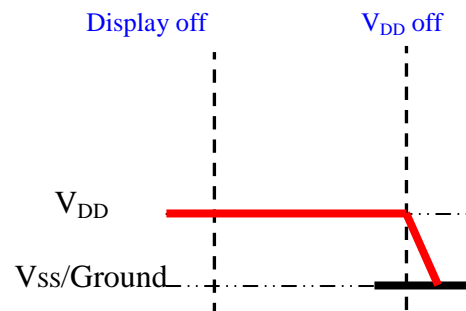

5.3 RESET CIRCUIT

After power up, the chip is initialised with the following status automatically:

1. Display is OFF
2. 5x8 Character Mode
3. Display start position is set at display RAM address 0
4. CGRAM address counter is set at 00h
5. Cursor is OFF
6. Blink is OFF
7. Contrast control register is set at 7Fh
8. OLED command set is disabled

Product No.	DD-2C20YW-2A	REV. A

Page	13 / 32
------	---------

5.4 ACTUAL APPLICATION EXAMPLE

Command usage and explanation of an actual example

<Initialisation Setting>

<Power up Sequence>

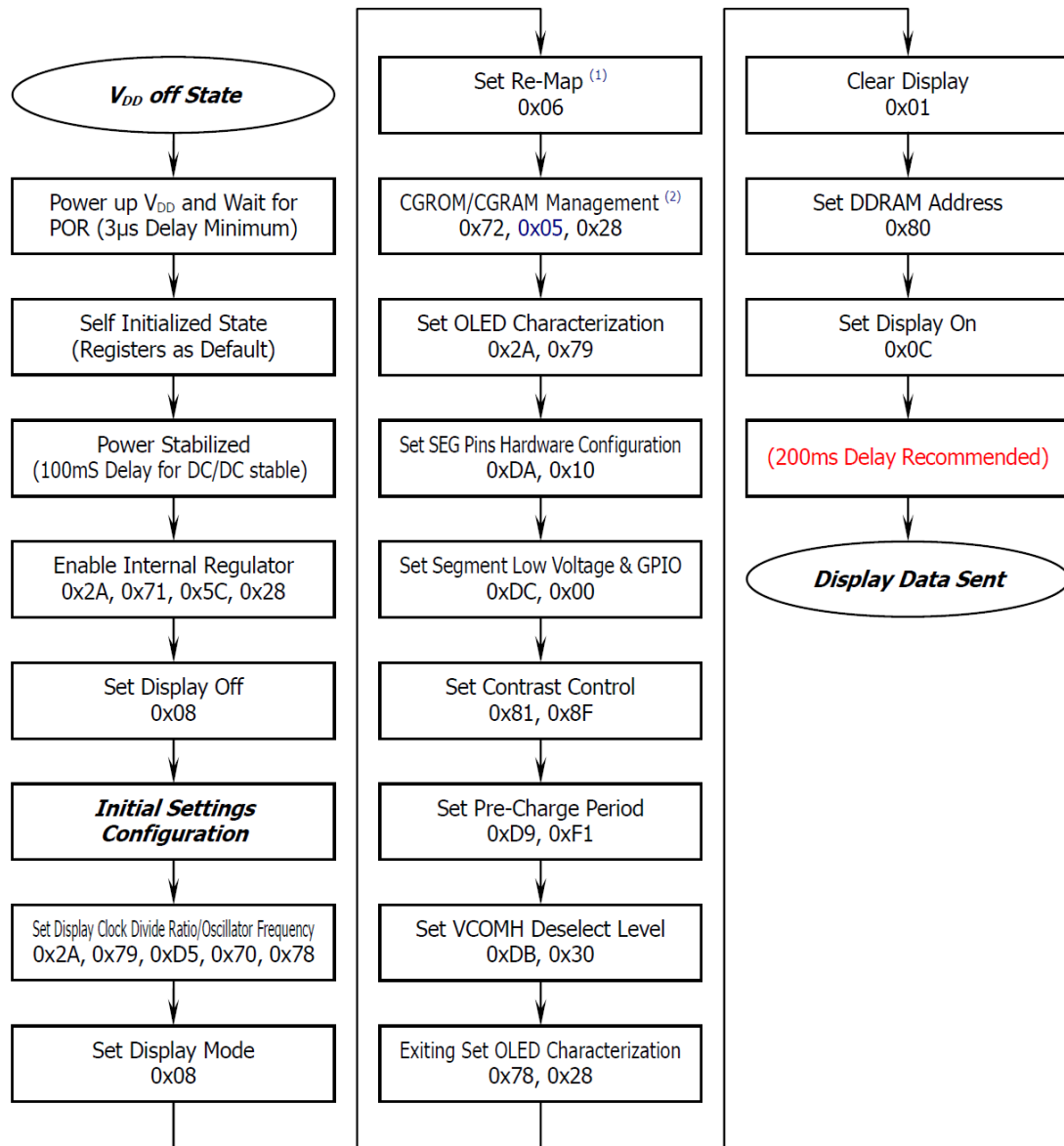

(1) This command could be programmable or defined by pin configuration.

(2) This command could be programmable or defined by pin configuration.

If the noise is accidentally occurred at the displaying window during the operation, please reset the display in order to recover the display function.

Product No.	DD-2C20YW-2A	REV. A

Page	14 / 32
------	---------

<Power down Sequence>

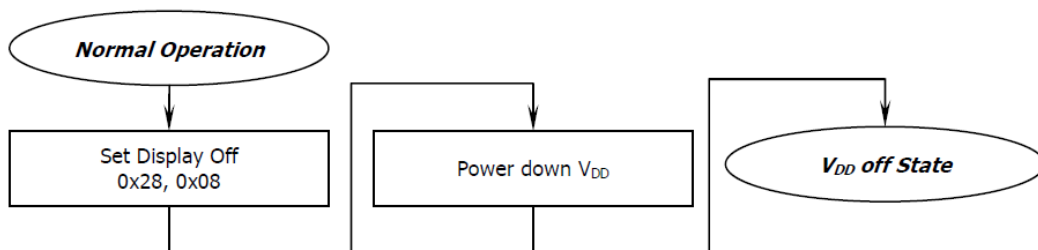

<Entering Sleep Mode>

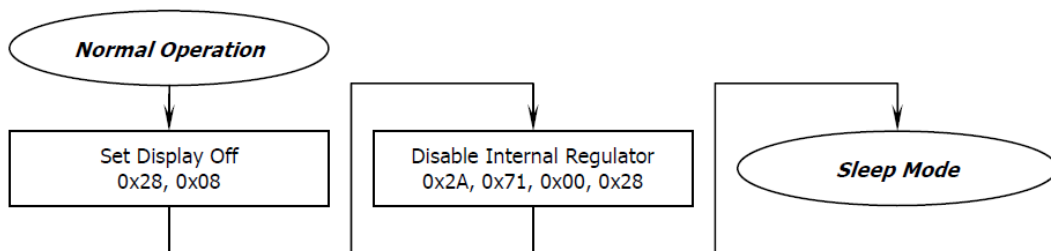

<Exiting Sleep Mode>

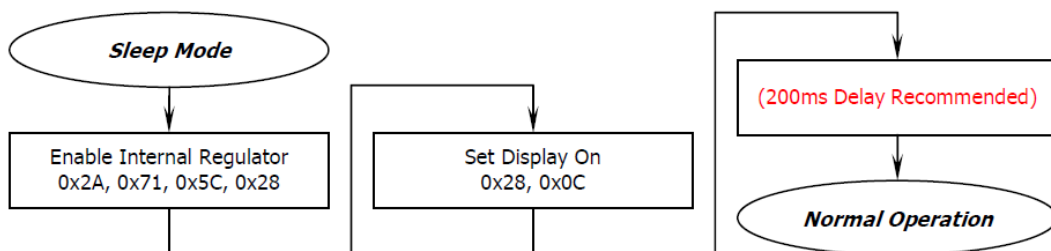

Product No.	DD-2C20YW-2A	REV. A

Page	15 / 32
------	---------

5.5 US2066 CGROM CHARACTER CODE

5.5.1 ROMA (ROM[1:0] = 01b)

10-4	0000	0001	0010	0011	0100	0101	0110	0111	1000	1001	1010	1011	1100	1101	1110	1111
0000	[img]	[img]	[img]	[img]	[img]	[img]	[img]	[img]	[img]	[img]	[img]	[img]	[img]	[img]	[img]	[img]
0001	[img]	[img]	[img]	[img]	[img]	[img]	[img]	[img]	[img]	[img]	[img]	[img]	[img]	[img]	[img]	[img]
0010	[img]	[img]	[img]	[img]	[img]	[img]	[img]	[img]	[img]	[img]	[img]	[img]	[img]	[img]	[img]	[img]
0011	[img]	[img]	[img]	[img]	[img]	[img]	[img]	[img]	[img]	[img]	[img]	[img]	[img]	[img]	[img]	[img]
0100	[img]	[img]	[img]	[img]	[img]	[img]	[img]	[img]	[img]	[img]	[img]	[img]	[img]	[img]	[img]	[img]
0101	[img]	[img]	[img]	[img]	[img]	[img]	[img]	[img]	[img]	[img]	[img]	[img]	[img]	[img]	[img]	[img]
0110	[img]	[img]	[img]	[img]	[img]	[img]	[img]	[img]	[img]	[img]	[img]	[img]	[img]	[img]	[img]	[img]
0111	[img]	[img]	[img]	[img]	[img]	[img]	[img]	[img]	[img]	[img]	[img]	[img]	[img]	[img]	[img]	[img]
1000	[img]	[img]	[img]	[img]	[img]	[img]	[img]	[img]	[img]	[img]	[img]	[img]	[img]	[img]	[img]	[img]
1001	[img]	[img]	[img]	[img]	[img]	[img]	[img]	[img]	[img]	[img]	[img]	[img]	[img]	[img]	[img]	[img]
1010	[img]	[img]	[img]	[img]	[img]	[img]	[img]	[img]	[img]	[img]	[img]	[img]	[img]	[img]	[img]	[img]
1011	[img]	[img]	[img]	[img]	[img]	[img]	[img]	[img]	[img]	[img]	[img]	[img]	[img]	[img]	[img]	[img]
1100	[img]	[img]	[img]	[img]	[img]	[img]	[img]	[img]	[img]	[img]	[img]	[img]	[img]	[img]	[img]	[img]
1101	[img]	[img]	[img]	[img]	[img]	[img]	[img]	[img]	[img]	[img]	[img]	[img]	[img]	[img]	[img]	[img]
1110	[img]	[img]	[img]	[img]	[img]	[img]	[img]	[img]	[img]	[img]	[img]	[img]	[img]	[img]	[img]	[img]
1111	[img]	[img]	[img]	[img]	[img]	[img]	[img]	[img]	[img]	[img]	[img]	[img]	[img]	[img]	[img]	[img]

Product No.	DD-2C20YW-2A	REV. A

Page	16 / 32
------	---------

5.5.2 ROMB (ROM[1:0] = 01b for default setting)

b5-4 b3-0	0000	0001	0010	0011	0100	0101	0110	0111	1000	1001	1010	1011	1100	1101	1110	1111
0000																
0001																
0010																
0011																
0100																
0101																
0110																
0111																
1000																
1001																
1010																
1011																
1100																
1101																
1110																
1111																

Product No.	DD-2C20YW-2A	REV. A

Page	17 / 32
------	---------

5.5.3 ROMC (ROM[1:0] = 10b)

b7-4 b3-0	0000	0001	0010	0011	0100	0101	0110	0111	1000	1001	1010	1011	1100	1101	1110	1111
0000																
0001																
0010																
0011																
0100																
0101																
0110																
0111																
1000																
1001																
1010																
1011																
1100																
1101																
1110																
1111																

Product No.	DD-2C20YW-2A	REV. A

Page	18 / 32
------	---------

5.5.4 Self-defined CGRAM (Character Generator RAM)

8 Addresses Available for Self-Defined Characters (OPR[1:0] = 00b')

b3-0 \ b7-4	0000	0001	0010	0011	0100	0101	0110	0111	1000	1001	1010	1011	1100	1101	1110	1111
0000																
0001																

8 Addresses Available for Self-Defined Characters (OPR[1:0] = 01b for default setting)

b3-0 \ b7-4	0000	0001	0010	0011	0100	0101	0110	0111	1000	1001	1010	1011	1100	1101	1110	1111
0000																
0001																

6 Addresses Available for Self-Defined Characters (OPR[1:0] = 10b)

b3-0 \ b7-4	0000	0001	0010	0011	0100	0101	0110	0111	1000	1001	1010	1011	1100	1101	1110	1111
0000																
0001																

0 Address Available for Self-Defined Characters (OPR[1:0] = 11b)

b3-0 \ b7-4	0000	0001	0010	0011	0100	0101	0110	0111	1000	1001	1010	1011	1100	1101	1110	1111
0000																
0001																

6 PACKAGING AND LABELLING SPECIFICATION

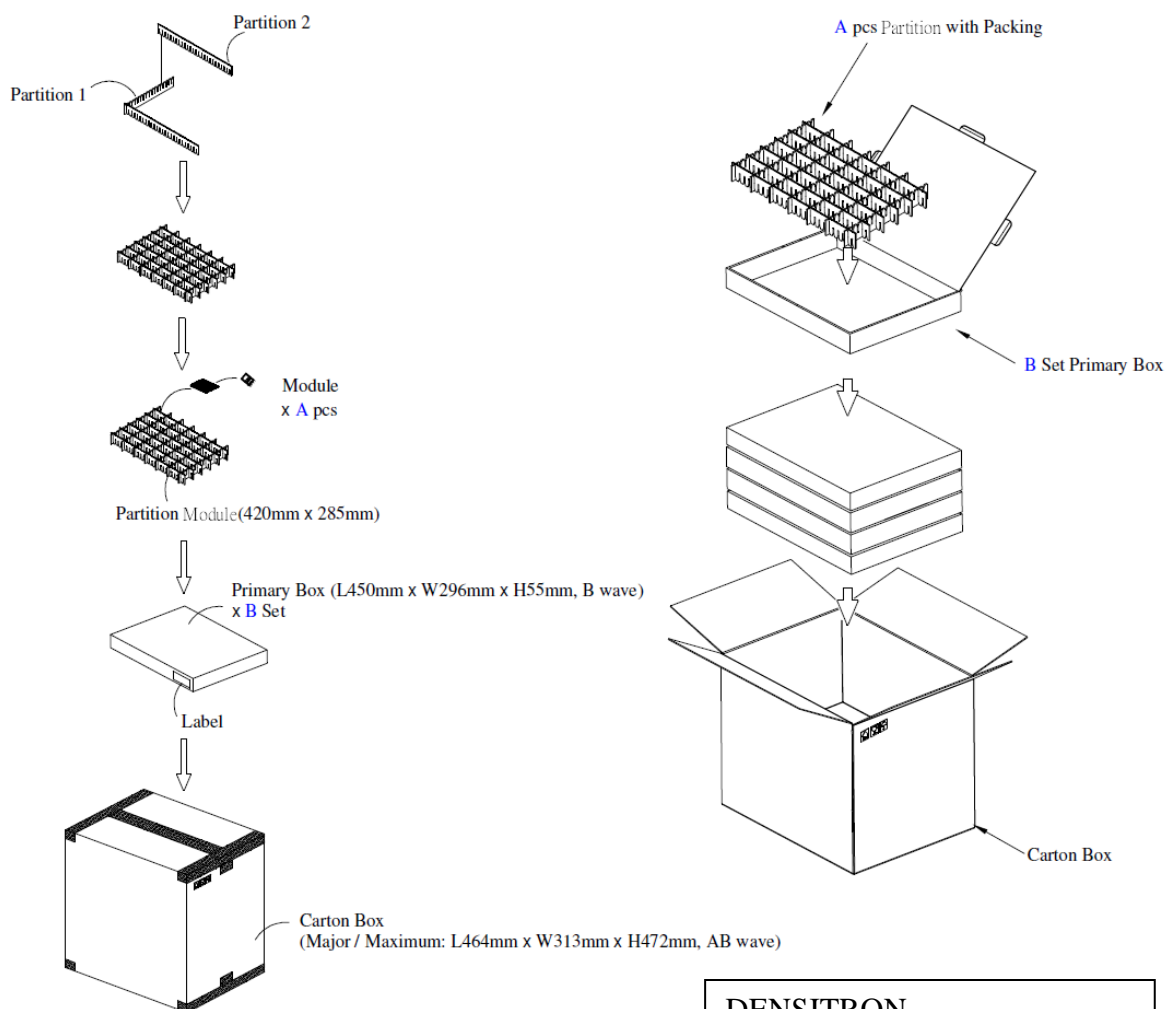

DENSITRON
DD-2C20YW-2A
TW YY MM

36 Pieces per box
1~8 boxes per carton

Product No.	DD-2C20YW-2A	REV. A

Page	20 / 32
------	---------

7 QUALITY ASSURANCE SPECIFICATION

7.1 CONFORMITY

The performance, function and reliability of the shipped products conform to the Product Specification.

7.2 DELIVERY ASSURANCE

7.2.1 DELIVERY INSPECTION STANDARDS

IPC-AA610, class 2 electronic assemblies standard

7.2.2 Zone definition

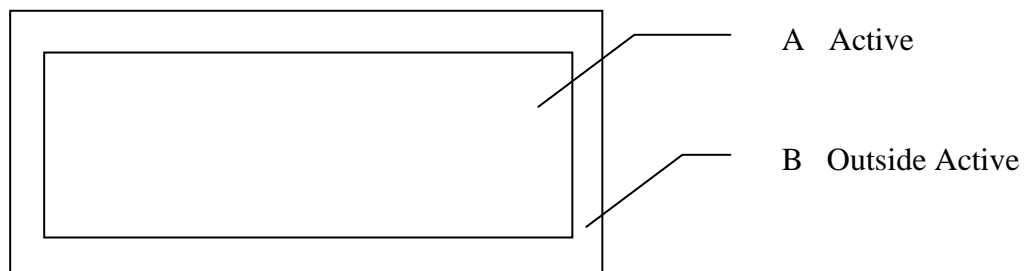

7.2.3 Visual inspection

Test and measurement to be conducted under following conditions :

Temperature:	23±5°C
Humidity:	55±15%RH
Fluorescent lamp:	30 W
Distance between the Panel & Eyes of the Inspector:	≥30cm
Distance between the Panel & the lamp:	≥50cm
Finger glove (or finger cover) must be worn by the inspector.	
Inspection table or jig must be anti-electrostatic	

Product No.	DD-2C20YW-2A	REV. A

Page	21 / 32
------	---------

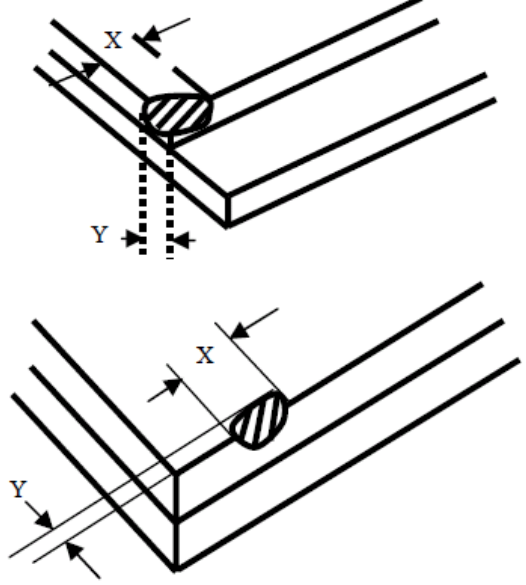

7.2.4 Standard of appearance inspection

Partition	AQL	Definition
Major	0.65	Defects in Pattern Check (Display On)
Minor	1.0	Defects in Cosmetic Check (Display Off)

Check Item	Classification	Criteria
Panel General Chipping	Minor	<p> $X > 6 \text{ mm}$ (Along with Edge) $Y > 1 \text{ mm}$ (Perpendicular to edge) </p> 

Product No.	DD-2C20YW-2A	REV. A

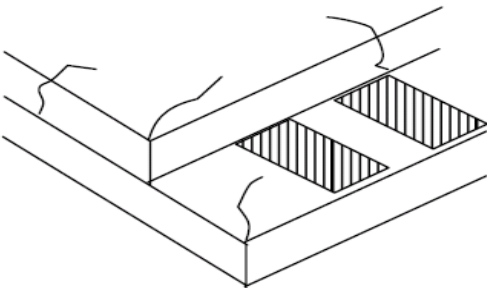
Page	22 / 32
------	---------

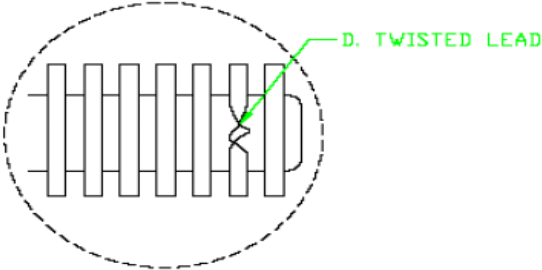
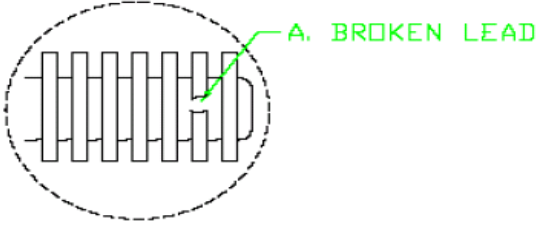
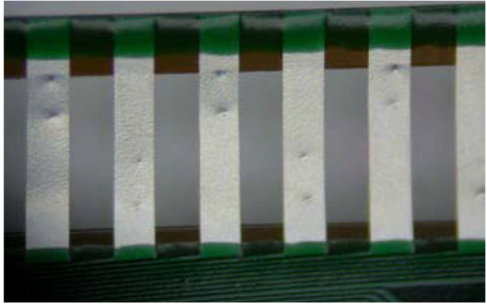
Check Item	Classification	Criteria
Panel Crack	Minor	Any crack is not allowable.  A 3D perspective diagram of a rectangular panel with a crack running across its top surface. The crack is shown as a jagged line.
Copper Exposed (Even Pin or Film)	Minor	Not Allowable by Naked Eye Inspection
Film or Trace Damage	Minor	 A close-up photograph of a yellow printed circuit board (PCB) showing a circular hole in the copper film, exposing the underlying substrate.
Terminal Lead Twist	Minor	Not Allowable  A schematic diagram of a terminal lead assembly. A dashed circle highlights a lead that is twisted. A green arrow points to the twisted lead with the label "D. TWISTED LEAD".
Terminal Lead Broken	Minor	Not Allowable  A schematic diagram of a terminal lead assembly. A dashed circle highlights a lead that is broken. A green arrow points to the broken lead with the label "A. BROKEN LEAD".
Terminal Lead Prober Mark	Acceptable	 A photograph of several vertical terminal leads. Each lead has a small, dark, rectangular mark on its top surface, which is a prober mark.

Product No.	DD-2C20YW-2A	REV. A

Page	23 / 32
------	---------

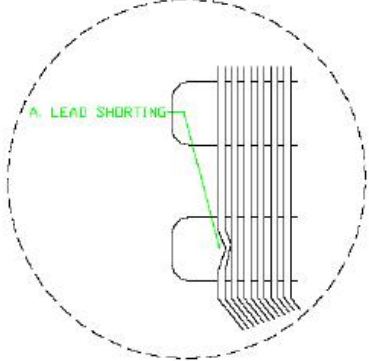
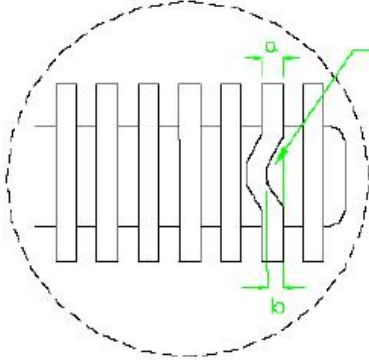
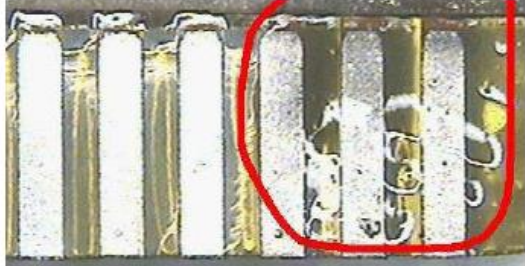
Check Item	Classification	Criteria
Terminal Lead Bent (Not Twist or Broken)	Minor	<p>NG if any bent lead cause lead shorting.</p> 
	Minor	<p>NG for horizontally bent lead more than 50% of its width.</p> 
Glue or Contamination on Pin (Couldn't Be Removed by Alcohol)	Minor	
Ink Marking on Back Side of panel (Exclude on Film)	Acceptable	Ignore for Any

Product No.	DD-2C20YW-2A	REV. A

Page	24 / 32
------	---------

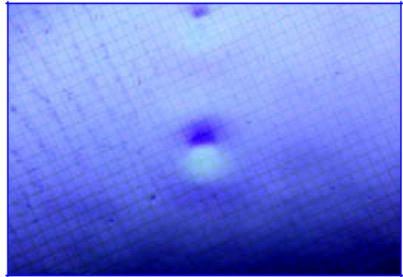
Check Item	Classification	Criteria
Any Dirt & Scratch on Polarizer's Protective Film	Acceptable	Ignore for not Affect the Polarizer
Scratches, Fiber, Line-Shape Defect (On Polarizer)	Minor	$W \leq 0.1$ Ignore $W > 0.1, L \leq 2$ $n \leq 1$ $L > 2$ $n = 0$
Dirt, Black Spot, Foreign Material, (On Polarizer)	Minor	$\Phi \leq 0.1$ Ignore $0.1 < \Phi \leq 0.25$ $n \leq 1$ $0.25 < \Phi$ $n = 0$
Dent, Bubbles, White spot (Any Transparent Spot on Polarizer)	Minor	$\Phi \leq 0.5$ → Ignore if no Influence on Display $0.5 < \Phi$ $n = 0$ 
Fingerprint, Flow Mark (On Polarizer)	Minor	Not Allowable

* Protective film should not be tear off when cosmetic check.

** Definition of W & L & Φ (Unit: mm): $\Phi = (a + b) / 2$

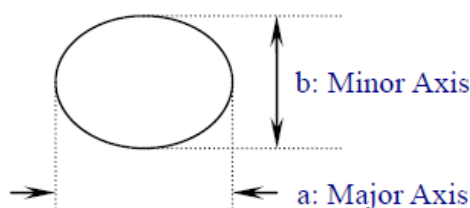
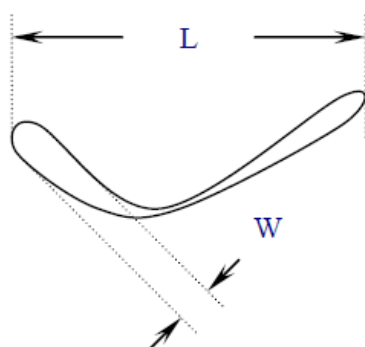

Product No.	DD-2C20YW-2A	REV. A

Page	25 / 32
------	---------

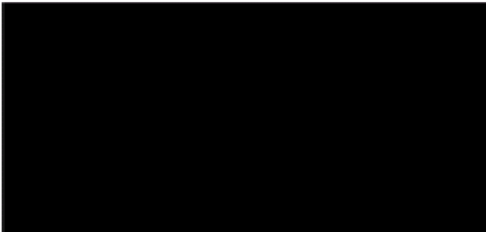
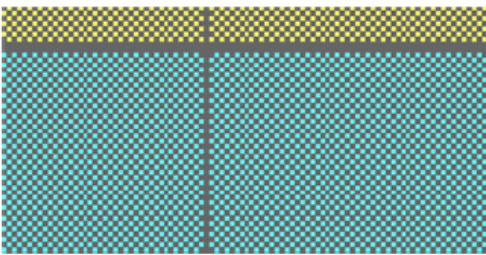
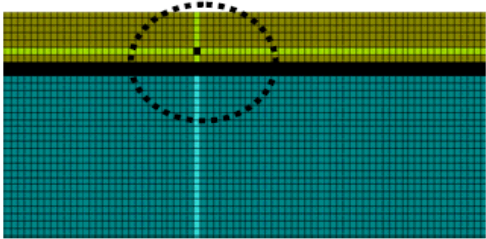
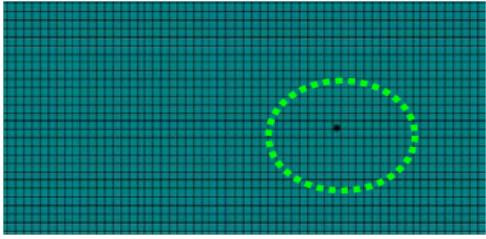
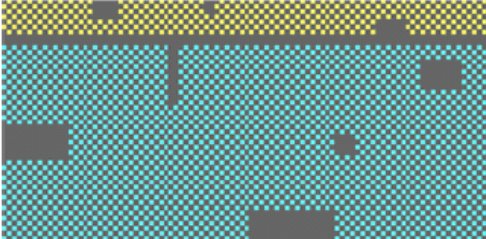
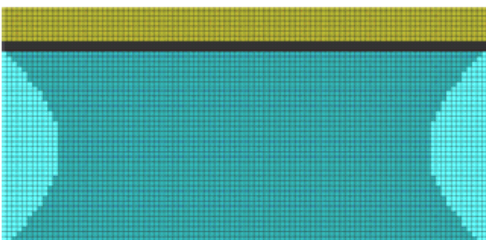
Check Item	Classification	Criteria
No Display	Major	
Flicker	Major	Not Allowable
Missing Line	Major	
Pixel Short	Major	
Darker Pixel	Major	
Wrong Display	Major	
Un-uniform	Major	

Product No.	DD-2C20YW-2A	REV. A

Page	26 / 32
------	---------

7.3 DEALING WITH CUSTOMER COMPLAINTS

7.3.1 Non-conforming analysis

Purchaser should supply Densitron with detailed data of non-conforming sample.

After accepting it, Densitron should complete the analysis in two weeks from receiving the sample.

If the analysis cannot be completed on time, Densitron must inform the purchaser.

7.3.2 Handling of non-conforming displays

If any non-conforming displays are found during customer acceptance inspection which Densitron is clearly responsible for, return them to Densitron.

Both Densitron and customer should analyse the reason and discuss the handling of non-conforming displays when the reason is not clear.

Equally, both sides should discuss and come to agreement for issues pertaining to modification of Densitron quality assurance standard.

Product No.	DD-2C20YW-2A	REV. A

Page	27 / 32
------	---------

8 RELIABILITY SPECIFICATION

8.1 RELIABILITY TESTS

Test Item	Test Condition	Evaluation and assessment
High Temperature Operation	70°C, 240 hours	No abnormalities in function and appearance
Low Temperature Operation	-40°C, 240 hours	No abnormalities in function and appearance
High Temperature Storage	85°C, 240 hours	No abnormalities in function and appearance
Low Temperature Storage	-40°C, 240 hours	No abnormalities in function and appearance
High Temperature & High Humidity Storage	60°C, 90%RH, 120 hours	No abnormalities in function and appearance
Thermal Shock	24 cycle of -40°C 1 Hour, 85°C 1 Hour. 60 Mins dwell	No abnormalities in function and appearance

- The samples used for above tests do not include polarizer.
- No moisture condensation is observed during tests.

8.1.1 FAILURE CHECK STANDARD

After the completion of the described reliability test, the samples were left at room temperature for 2 hrs prior to conducting the failure test at 23±5 °C; 55±15% RH

8.2 LIFE TIME

Item	Description
1	Function, performance, appearance, etc. shall be free from remarkable deterioration more than 80,000 hours under 120 cd/m ² brightness and 50% Checkerboard, humidity (50% RH), and in area not exposed to direct sunlight. VDD=5.0V, Ta=25°C, 50% Checkerboard. Software configuration follows Section 5.4 Initialization.
2	End of lifetime is specified as 50% of initial brightness. The average operating lifetime at room temperature is estimated by the accelerated operation at high temperature conditions.

Product No.	DD-2C20YW-2A	REV. A
-------------	--------------	--------

Page	28 / 32
------	---------

9 HANDLING PRECAUTIONS

9.1 HANDLING PRECAUTIONS

- 1) Since the display panel is being made of glass, do not apply mechanical impacts such as dropping from a high position.
- 2) If the display panel is broken by some accident and the internal organic substance leaks out, be careful not to inhale nor lick the organic substance.
- 3) If pressure is applied to the display surface or its neighborhood of the OLED display module, the cell structure may be damaged and be careful not to apply pressure to these sections.
- 4) The polarizer covering the surface of the OLED display module is soft and easily scratched. Please be careful when handling the OLED display module.
- 5) When the surface of the polarizer of the OLED display module has soil, clean the surface. It takes advantage of by using following adhesion tape.
 - * Scotch Mending Tape No. 810 or an equivalent
 Never try to breathe upon the soiled surface nor wipe the surface using cloth containing solvent such as ethyl alcohol, since the surface of the polarizer will become cloudy.
 Also, pay attention that the following liquid and solvent may spoil the polarizer:
 - * Water
 - * Ketone
 - * Aromatic Solvents
- 6) Hold OLED display module very carefully when placing OLED display module into the system housing. Do not apply excessive stress or pressure to OLED display module. And, do not over bend the film with electrode pattern layouts. These stresses will influence the display performance. Also, secure sufficient rigidity for the outer cases.

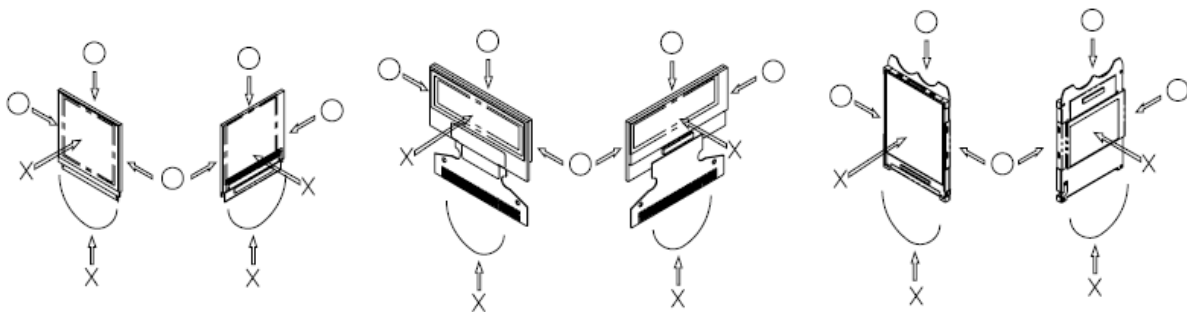

- 7) Do not apply stress to the LSI chips and the surrounding molded sections.
- 8) Do not disassemble nor modify the OLED display module.
- 9) Do not apply input signals while the logic power is off.
- 10) Pay sufficient attention to the working environments when handling OLED display modules to prevent occurrence of element breakage accidents by static electricity.
 - * Be sure to make human body grounding when handling OLED display modules.
 - * Be sure to ground tools to use or assembly such as soldering irons.
 - * To suppress generation of static electricity, avoid carrying out assembly work under dry environments.

Product No.	DD-2C20YW-2A	REV. A

Page	29 / 32
------	---------

* Protective film is being applied to the surface of the display panel of the OLED display module. Be careful since static electricity may be generated when exfoliating the protective film.

- 11) Protection film is being applied to the surface of the display panel and removes the protection film before assembling it. At this time, if the OLED display module has been stored for a long period of time, residue adhesive material of the protection film may remain on the surface of the display panel after removed of the film. In such case, remove the residue material by the method introduced in the above Section 5).
- 12) If electric current is applied when the OLED display module is being dewed or when it is placed under high humidity environments, the electrodes may be corroded and be careful to avoid the above.

9.2 STORAGE PRECAUTIONS

- 1) When storing OLED display modules, put them in static electricity preventive bags avoiding exposure to direct sun light nor to lights of fluorescent lamps, etc. and, also, avoiding high temperature and high humidity environments or low temperature (less than 0°C) environments. (We recommend you to store these modules in the packaged state when they were shipped from Densitron Technologies Plc.) At that time, be careful not to let water drops adhere to the packages or bags nor let dewing occur with them.
- 2) If electric current is applied when water drops are adhering to the surface of the OLED display module, when the OLED display module is being dewed or when it is placed under high humidity environments, the electrodes may be corroded and be careful about the above.

9.3 DESIGNING PRECAUTIONS

- 1) The absolute maximum ratings are the ratings which cannot be exceeded for OLED display module, and if these values are exceeded, panel damage may be happen.
- 2) To prevent occurrence of malfunctioning by noise, pay attention to satisfy the VIL and VIH specifications and, at the same time, to make the signal line cable as short as possible.
- 3) We recommend you to install excess current preventive unit (fuses, etc.) to the power circuit (VDD). (Recommend value: 0.5A)
- 4) Pay sufficient attention to avoid occurrence of mutual noise interference with the neighboring devices.
- 5) As for EMI, take necessary measures on the equipment side basically.
- 6) When fastening the OLED display module, fasten the external plastic housing section.
- 7) If power supply to the OLED display module is forcibly shut down by such errors as taking out the main battery while the OLED display panel is in operation, we cannot guarantee the quality of this OLED display module.
- 8) The electric potential to be connected to the rear face of the IC chip should be as follows: US2066
* Connection (contact) to any other potential than the above may lead to rupture of the IC.

Product No.	DD-2C20YW-2A	REV. A

Page	30 / 32
------	---------

9.4 OTHER PRECAUTIONS

- 1) When an OLED display module is operated for a long of time with fixed pattern may remain as an after image or slight contrast deviation may occur. Nonetheless, if the operation is interrupted and left unused for a while, normal state can be restored. Also, there will be no problem in the reliability of the module.
- 2) To protect OLED display modules from performance drops by static electricity rapture, etc., do not touch the following sections whenever possible while handling the OLED display modules.
 - * Pins and electrodes
 - * Pattern layouts such as the FPC
- 3) With this OLED display module, the OLED driver is being exposed. Generally speaking, semiconductor elements change their characteristics when light is radiated according to the principle of the solar battery. Consequently, if this OLED driver is exposed to light, malfunctioning may occur.
 - * Design the product and installation method so that the OLED driver may be shielded from light in actual usage.
 - * Design the product and installation method so that the OLED driver may be shielded from light during the inspection processes.
- 4) Although this OLED display module stores the operation state data by the commands and the indication data, when excessive external noise, etc. enters into the module, the internal status may be changed. It therefore is necessary to take appropriate measures to suppress noise generation or to protect from influences of noise on the system design.
- 5) We recommend you to construct its software to make periodical refreshment of the operation statuses (re-setting of the commands and re-transference of the display data) to cope with catastrophic noise.

Product No.	DD-2C20YW-2A	REV. A

Page	31 / 32
------	---------

10 SUPPORTED ACCESSORIES

10.1 DUO KIT

Densitron has developed an easy to use yet powerful development and demonstration tool for driving its range of Passive Matrix OLED displays from the USB port of a PC.

DUO (Densitron USB OLED) kit is hot pluggable and does not require extra cables or power supply to run, allowing users to be up and running in minutes.

The kit consists of an OLED display with transition Board, USB controller card, mini USB cable and a CD with software application and drivers.



Part number: TBD

10.2 TRANSITION BOARD CARD

A Transition board card is like a daughterboard which is meant to be a circuit board for connections between the baseboards (DUO).

It has connector pins for interfacing between the display and the baseboards.

It also includes the OLED display.

Part number: TBD

10.3 CONNECTORS

Type: Pin Through Hole

No. of connections: 16

Pitch: 2.54mm

10.4 APPLICATION NOTES AND EXAMPLE CODES

On request to Densitron

Product No.	DD-2C20YW-2A	REV. A

Page	32 / 32
------	---------