

SAFEMASTER Emergency Stop Module With Time Delay LG 5928



Your advantage

- Compact, flexible and safe
- Short response time
- Ideal for designs according to the new safety standards

Features

- **According to**
 - Performance Level (PL) e and category 4 to EN ISO 13849-1: 2008
 - SIL Claimed Level (SIL CL) 3 to IEC/EN 62061
 - Safety Integrity Level (SIL) 3 to IEC/EN 61508 and IEC/EN 61511
- Output: 2 NO instantaneous contacts and 1 release delay contact
- 1- or 2-channel connection
- Line fault detection at the ON pushbuttons at connection on terminals S33-S34
- Manual restart with button on S33-S34 or automatic restart with bridge between S13-S34
- With or without cross fault monitoring in the E-stop loop
- Indication for released time circuit
- LED indication for supply, channel 1/2 and release delayed contacts
- Wire connection: also 2 x 1.5 mm² stranded ferruled (isolated), DIN 46 228-1/-2/-3/-4 or 2 x 2.5 mm² stranded ferruled DIN 46 228-1/-2/-3
- As option with pluggable terminal blocks for easy exchange of devices
 - with screw terminals
 - or with cage clamp terminals
- Width 22.5 mm

Function Diagram

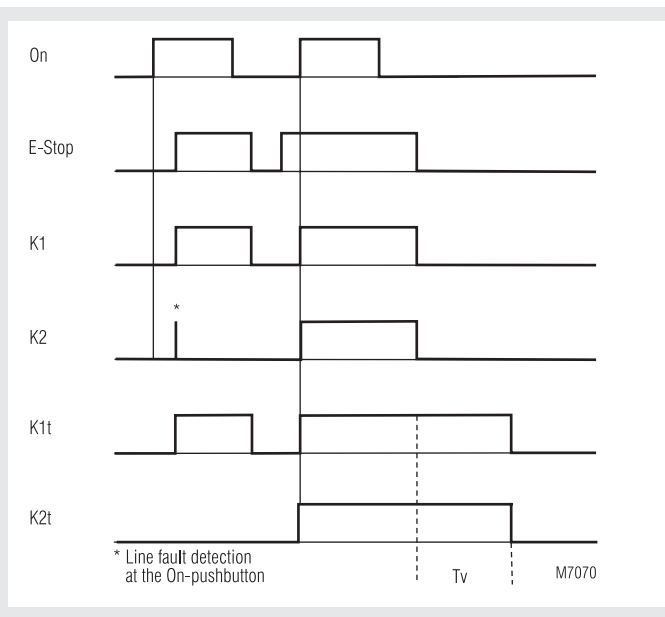

Approval and Marking



*) see variants

Application

- Protection of people and machines
- Emergency stop circuits on machines, Stop category 1 can be realised
 - Monitoring of safety gates

Block Diagram

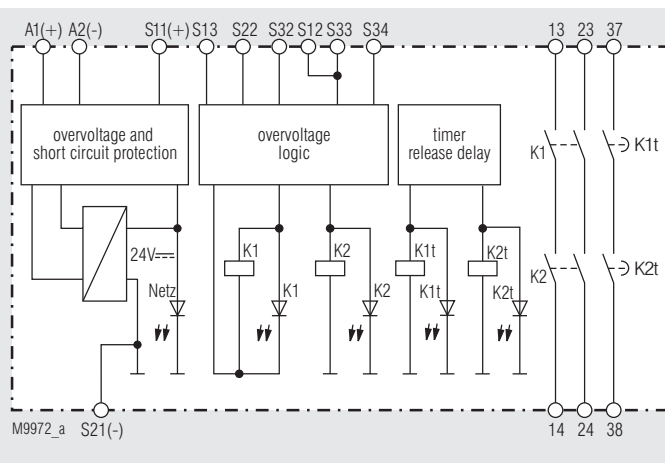

Indication

- upper LED: on when supply connected
lower LEDs: on, when relay K₁ and K₂ resp. K_{1t} and K_{2t} energized

Circuit Diagram

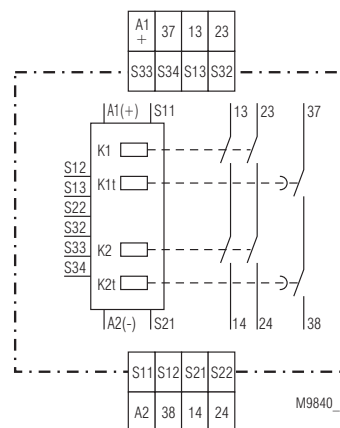

LG 5928.41

Connection Terminals	
Terminal designation	Signal designation
A1(+)	+ / L
A2 (-)	- / N
S11, S21, S13, S33	Inputs
S12, S22, S32, S34	Outputs
13, 14, 23, 24	Positive driven NO contacts for release circuit
37, 38	Positive guided No contacts for release delay circuit

Notes

To select automatic restart terminals S13 - S34 must be bridged, S33 - S34 must be opened. Open terminals S13 - S34 select manual restart, the On-button must then be connected to S33 - S34.

Line fault detection on On-button:

The line fault detection is only active when the time delayed relays K1₁ and K2₁ have released and then S12 (channel A) and S32 (channel B) are switched simultaneously. If the On-button is closed before S12, S32 is connected to voltage (also when line fault across On-button), the output contacts will not close. The unit will not restart before the time delay is finished.

A line fault across the On-button which occurred after activation of the relay, will be detected with the next activation and the output contacts will not close. If a line fault occurs after the voltage has been connected to S12, S32, the unit will be activated because this line fault is similar to the normal On-function.

The unit can be operated with single channel and 2-channel operation with cross fault monitoring. For connection please refer to application examples.

The terminal S21 permits the operation of the device in IT-systems with insulation monitoring, serves as a reference point for testing the control voltage and is used to connect the E-stop loop when cross fault monitoring is selected. Connecting the terminal S21 to the protective ground bridges the internal short-circuit protection of Line A2(-). The short-circuit protection of line A1(+) remains active.

ATTENTION - AUTOMATIC START!



According to IEC/EN 60 204-1 part 9.2.5.4.2 it is not allowed to restart automatically after emergency stop. Therefore the machine control has to disable the automatic start after emergency stop.

Technical Data

Input

Nominal voltage U_N:	DC 24 V
Voltage range:	0.9 ... 1.1 U _N
Nominal consumption:	approx. 3.5 W
Min. Off-time:	1 s
Control voltage S11:	DC 23 V at U _N device not activated
Control current via S12, S32:	each 40 mA at U _N
Min. voltage to terminals S12, S32:	DC 19 V device not activated
Short-circuit protection:	Internal PTC
Overvoltage protection:	Internal VDR

Output

Contacts:	2 NO contacts instantaneous, and 1 contact release delay
Operating time typ. at U_N:	
manual start:	25 ms
automatic start at U _N :	100 ms
Release delay typ. at U_N:	
in case of break of supply voltage:	20 ms
in case of break of S12, S22 and S32:	10 ms

Technical Data

Time delay tv

(release delayed):

Auxiliary supply must be connected for time delay

Time ranges:

0.1 ... 1 s	3.0 ... 30 s
0.3 ... 3 s	6.0 ... 60 s
0.5 ... 5 s	30 ... 300 s
1.0 ... 10 s	

Other ranges or values on request

± 1 % of setting value

Repeat accuracy:

Contact type:

Nominal output voltage:

forcibly guided

AC 250 V

DC: see limit curve for arc-free operation

DC: see limit curve for arc-free operation

Max switching current:

Thermal current I_{th}:

in 1 contact path:

13 / 14 or 23 / 24:

max. 8 A (see quadratic total current limit curve)

37 / 38:

max. 6 A (see quadratic total current limit curve)

Switching capacity

to AC 15

NO contact:

3 A / AC 230V

IEC/EN 60 947-5-1

to DC 13

NO contacts:

2 A / DC 24 V

Electrical life

to AC 15 at 2 A, AC 230 V:

10⁵ switching cycles IEC/EN 60 947-5-1

Permissible operating frequency:

max. 360 switching cycles / h

with short release delay time

Short circuit strength

max. fuse rating

13 / 14 or 23 / 24:

10 A gL

IEC/EN 60 947-5-1

37 / 38:

4 A gL

IEC/EN 60 947-5-1

Line circuit breaker:

B 6 A

(max. short circuit current + 300 A)

Mechanical life:

10 x 10⁶ switching cycles

General Data

Operating mode:

Continuous operation

Temperature range:

- 15 ... + 55 °C

Clearance and creepage distances

rated impuls voltage /

pollution degree:

4 kV / 2

IEC 60 664-1

EMC

Electrostatic discharge:

8 kV (air)

IEC/EN 61 000-4-2

HF irradiation:

10 V / m

IEC/EN 61 000-4-3

Fast transients:

2 kV

IEC/EN 61 000-4-4

Surge voltages

between

wires for power supply:

1 kV

IEC/EN 61 000-4-5

between wire and ground:

2 kV

IEC/EN 61 000-4-5

HF-wire guided:

10 V

IEC/EN 61 000-4-6

Interference suppression:

Limit value class B

EN 55 011

Degree of protection

Housing:

IP 40

IEC/EN 60 529

Terminals:

IP 20

IEC/EN 60 529

Housing:

Thermoplastic with V0 behaviour

according to UL subject 94

Vibration resistance:

Amplitude 0.35 mm,

frequency 10 ... 55 Hz IEC/EN 60 068-2-6

Climate resistance:

15 / 055 / 04

IEC/EN 60 068-1

Terminal designation:

EN 50 005

Wire connection

DIN 46 228-1/-2/-3/-4

screw terminal

(fixed):

1 x 4 mm² solid or

1 x 2.5 mm² stranded ferruled (isolated) or

2 x 1.5 mm² stranded ferruled (isolated) or

2 x 2.5 mm² solid

Insulation of wires

or sleeve length:

8 mm

Terminal blocks

with screw terminals

Max. cross section:

1 x 2.5 mm² solid or

1 x 2.5 mm² stranded ferruled (isolated)

Insulation of wires

or sleeve length:

8 mm

Technical Data

Terminal blocks

with cage clamp terminals

Max. cross section:	1 x 4 mm ² solid or 1 x 2.5 mm ² stranded ferruled (isolated)
Min. cross section:	0.5 mm ²
Insulation of wires or sleeve length:	12 ±0.5 mm
Wire fixing:	Plus-minus terminal screws M3.5 box terminals with wire protection

Insulation of wires

or sleeve length:	8 mm	
Mounting:	DIN rail	IEC/EN 60 715
Weight:	approx. 210 g	

Dimensions

Width x height x depth:

LG 5928:	22.5 x 90 x 121 mm
LG 5928PC:	22.5 x 111 x 121 mm
LG 5928PS:	22.5 x 104 x 121 mm

Safety Related Data (only instantaneous contacts)

Values according to EN ISO 13849-1:

Category:	4	
PL:	e	
MTTF _d :	351.8	a
DC / DC _{avg} :	99.0	%
d _{op} :	365	d/a (days/year)
h _{op} :	24	h/d (hours/day)
t _{Zyklus} :	3600	s/Zyklus
	± 1	/h (hour)

Values according to IEC/EN 62061 / IEC/EN 61508 / IEC/EN 61511:

SIL CL:	3	IEC/EN 62061
SIL:	3	IEC/EN 61508 / IEC/EN 61511
HFT:	1	
DC / DC _{avg} :	99.0	%
SFF:	99.7	%
PFH _D :	1.37E-10	h ⁻¹
PFD:	1.18E-05	
T ₁ :	20	a (year)

Safety Related Data (only delayed contacts)

Values according to EN ISO 13849-1:

Category:	3	
PL:	d	
MTTF _d :	495.4	a
DC / DC _{avg} :	97.3	%
d _{op} :	365	d/a (days/year)
h _{op} :	24	h/d (hours/day)
t _{Zyklus} :	3600	s/Zyklus
	± 1	/h (hour)

Values according to IEC/EN 62061 / IEC/EN 61508 / IEC/EN 61511:

SIL CL:	2	IEC/EN 62061
SIL:	2	IEC/EN 61508 / IEC/EN 61511
HFT:	1	
DC / DC _{avg} :	97.3	%
SFF:	99.1	%
PFH _D :	2.76E-10	h ⁻¹
PFD:	2.34E-05	
T ₁ :	20	a (year)

¹⁾ HFT = Hardware-Failure Tolerance



The values stated above are valid for the standard type.
Safety data for other variants are available on request.

The safety relevant data of the complete system has to be determined by the manufacturer of the system.

UL-Data

The safety functions were not evaluated by UL. Listing is accomplished according to requirements of Standard UL 508, "general use applications"

Nominal voltage U_N: DC 24 V

Ambient temperature: -15 ... +55°C

Switching capacity:
Ambient temperature 45°C

Contact 13/14 and 23/24:
Pilot duty R300
6A 250Vac Resistive
6A 24Vdc Resistive or G.P.
Contact 37/38:
8A 250Vac Resistive
8A 24Vdc Resistive or G.P.

Ambient temperature 55°C:

Contact 13/14 and 23/24:
Pilot duty R300
5A 250Vac Resistive
5A 24Vdc Resistive or G.P.
Contact 37/38:
7A 250Vac Resistive
7A 24Vdc Resistive or G.P.

Wire connection:

Screw terminals fixed: 60°C / 75°C copper conductors only
AWG 20 - 12 Sol/Str Torque 0.8 Nm
Plug in screw: AWG 20 - 14 Sol Torque 0.8 Nm
AWG 20 - 16 Str Torque 0.8 Nm
Plug in cage clamp: AWG 20 - 12 Sol/Str



Technical data that is not stated in the UL-Data, can be found in the technical data section.

Standard Type

LG 5928.41/61 DC 24 V 1 ... 10 s

Article number: 0061683

- Output: 2 NO contacts instantaneous and
1 NO contacts release delayed
- Nominal voltage U_N: DC 24 V
- Time delay tv: 1 ... 10 s
- Width: 22.5 mm

Variants

LG 5928.41/61:	with redundant time circuits to disconnect K1t and K2t, adjustable time. Each time circuit operates one output relay
LG 5928.41/001/61:	as LG 5928.41/61, but with fixed time delay Fixed times: 1 s, 3 s, 5 s, 10 s, 300 s other values on request
LG 5928.41/100/61:	as LG 5928.41/61, but deactivation of the first time relay deactivates the second time relay i. e. both relays switch off simultaneously
LG 5928.41/101/61:	as LG 5928.41/100/61, but with fixed time delay Fixed times: 1 s, 3 s, 5 s, 10 s, 300 s other times on request

Ordering example for variants:

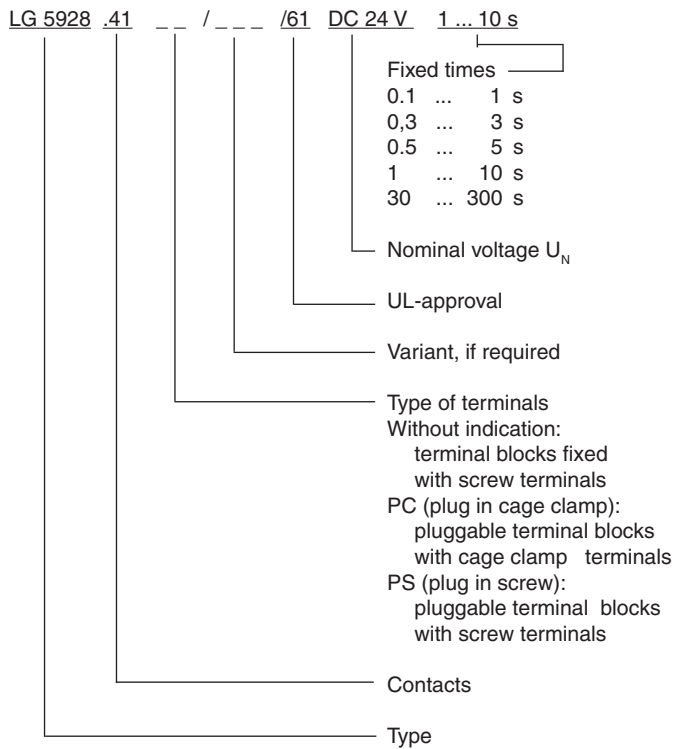

Options with Pluggable Terminal Blocks

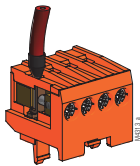

Screw terminal (PS/plugin screw)

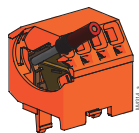

Cage clamp terminal (PC/plugin cage clamp)

Notes

Removing the terminal blocks with cage clamp terminals

- 1 The unit has to be disconnected.
2. Insert a screwdriver in the side recess of the front plate.
3. Turn the screwdriver to the right and left.
4. Please note that the terminal blocks have to be mounted on the belonging plug in terminations.

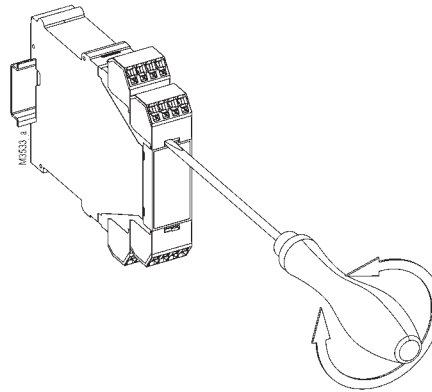

Characteristics

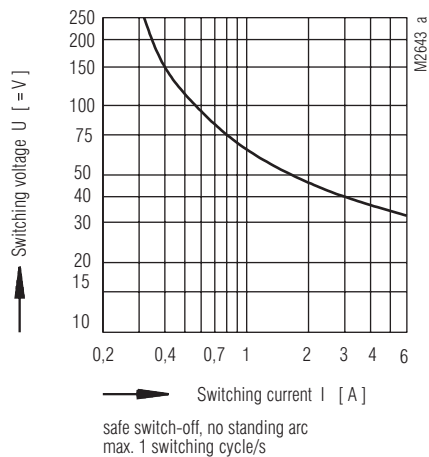

Limit curve for arc-free operation

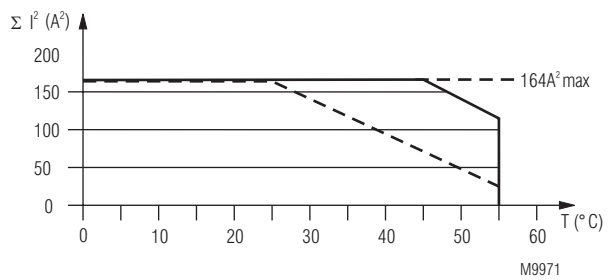

— device mounted on distance with air circulation.
max. current at 55°C over
3 contactrows = $2 \times (7A)^2 + (5A)^2 = 123A^2$

- - - device mounted without distance heated by
devices with same load.
max current at 55°C over
3 contactrows = $3 \times (3A)^2 = 27A^2$

$$\Sigma I^2 = I_1^2 + I_2^2 + I_3^2$$

I_1, I_2, I_3 - current in contactrows

Quadratic total current limit curve

