

VARIMETER EDS Insulation fault locator RR 5887

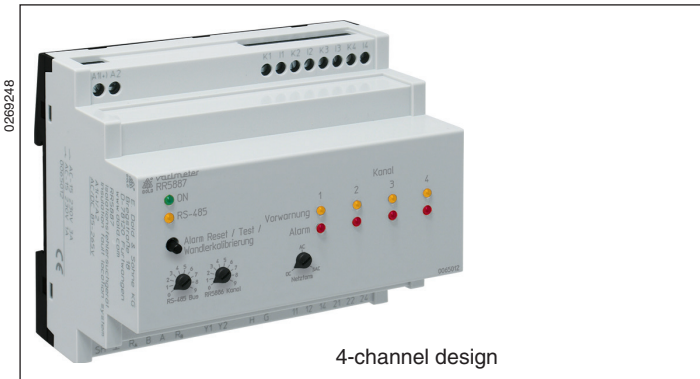

Product description

The locating current generator RR 5886 in connection with the insulation fault locator RR 5887 monitors and localises insulation faults in complex AC/DC networks (IT systems). The external current transformers work independently of each other, calibrate themselves and are simply connected to the measuring channels of the insulation fault locator RR 5887. The number of measuring channels is increased by combining several insulation fault locators via a RS-485 bus connection. The search for insulation faults in extensive networks can be refined in this manner. Two different alarm levels facilitate the timely detection of a dangerous insulation state. The devices are operated easily and intuitively thanks to automatic balancing and a clear layout of the setting elements. The early detection and localisation of insulations faults permits their quick and targeted correction. As user you will benefit from the operating reliability and high availability of your system.

Your Advantages

- Quick correction of insulation faults in complex power networks
- Universal auxiliary voltage range AC/DC 85 ... 265 V
- Easy operation

Features

- Insulation troubleshooting in DC, AC and mixed IT systems in connection with the locating current injector RR 5886 according to DIN EN 61557-9 (VDE 0413-9):2009 and DIN EN 61557-1 (VDE 0413-1)
- Insulation coordination according to IEC 60664-1
- Connection of max. 4 or 8 differential current transformers depending on the design
- RS-485 bus connection to synchronise the test current output and optionally for the connection to the EDS measuring bus for reading insulation fault currents
- Status output of insulation fault detection via external switching output
- Memory characteristics adjustable via bridge Y1-Y2
- Collective signalling relay to output preliminary warning and alarm states
- Pushbutton for manual reset of alarm states as well as testing of differential current transformers and their calibration
- Terminal connection for the storage of alarm states
- Width: 105 mm

Approvals and Markings



Application

- Insulation fault detection in complex AC/DC networks
- Industry, shipbuilding, plant engineering, PV systems
- Quick fault correction of insulation faults in medical facilities

Function Diagram

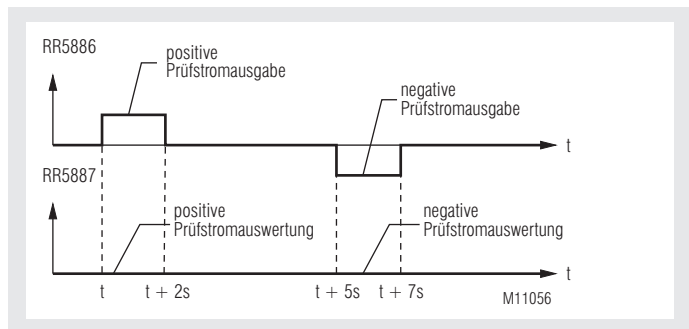

Circuit Diagram

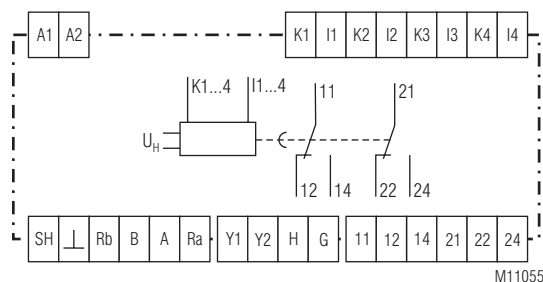

Indication

- green LED "ON": On, when supply connected
- yellow LED Kanal 1..4: Pre-warning: Display of an insulation fault current > 1 mA in the corresponding channel
- red LED Kanal 1..4: Alarm: Display of an insulation fault current > 5 mA in the corresponding channel
- yellow LED „RS-485“: Indicates RS-485 bus activity and active insulation fault detection

Connection Terminals

Terminal designation	Signal designation
A1(+), A2	Auxiliary voltage AC or DC
K1..K4/ I1..I4	Current transformer measur. channel
SH, GND, Rb, B, A, Ra	RS-485 Bus (galvanic separation)
Y1, Y2	Switching input Alarm storage
G, H	Status switching output Insulation fault detection
11, 12, 14	Indicator relay prewarning (changeover contact)
21, 22, 24	Indicator relay alarm (changeover contact)



Notes



Switching input

The device is equipped with a switching input (terminals Y1, Y2), which can be furnished either with a simple wire bridge or selected actively as digital control input from an external device with max. 24 V DC.

The input is low-active, i.e. when applying a low-level, the function "ALARM MEMORY" is active, otherwise it is inactive.

If the function is active, no prewarning/alarm states are reset following an insulation fault locating cycle. A reset takes place only after pushing the "Alarm reset/ Test/ Transformer calibration" button for at least 2 sec.

Y1  *ALARM MEMORY active*
Y2  - Alarm states are preserved
- Manually resettable via pushbutton

Y1  *ALARM MEMORY inactive*
Y2  - Alarm states are updated after each measuring cycle

Technical Data

Auxiliary voltage

Nominal voltage range

A1(+) / A2: AC/DC 100 ... 230 V

Voltage range: AC/DC 85 ... 265 V

Nominal consumption: < 3 VA

Monitored network

Nominal voltage: DC / AC / 3AC 24 ... 360 V

Voltage range AC / 3AC

L1/L2/L3: 21 ... 400 V, 40 ... 60 Hz

Voltage range DC

L1(+)/L2(-): 21 ... 400 V

Rated current range for

insulation test currents: 1 ... 5 mA

Maximum test current output: 6.5 mA

Response sensitivity: 0.5 mA

Bus

(galvanic separation): RS-485

Differential current transformer

Terminals: K1, I1 ... K4, I4

Differential current transformer: ND 5017

Burden: 180 Ω

Rated voltage: 500 V

Rated frequency: 40 ... 60 Hz

Response sensitivity: 0.2 mA

Measuring range: 0.5 ... 10 mA

Number of measuring channel: 4

Switching input

Terminals: Y1, Y2

Configuration (passive)

Low-level: Bridge set / input low resistance

High-level: Input open / input high-resistance

Configuration (active)

Voltage range (low/high): 0V / 12 ... 24 V

Max. switching current (24 V): 0.5 mA

Switching output

Terminals: H(+), G(-)

Switching output (passive): transistor outputs

Test current output: Output low resistance
(minimal 220 Ω via PTC)

No test current output: Output high resistance

Switching voltage max.: 24 V

Switching current max. (24 V): 10 mA

Technical Data

RS-485 Bus

Terminals: SH, L, Rb, B, A, Ra

Bus: galvanic separation

Device mode

Bus-Master/Slave: adjustable via rotational switch

Transmission medium: twisted, shielded two-wire line (SH)

Data transmission rate: 115.2 kBit/s

Network termination: Bus termination via bridges Rb, B and Ra, A

Connection alarm signalling relay

Output: 2 changeover contacts

Nominal voltage: AC/DC 24 ... 240 V

Limiting continuous current

($I_{th, max}$): 2 x 5 A

Switching capacity

to AC 15

NO contact: 3 A / AC 230V IEC/EN 60 947-5-1

NC contact: 1 A / AC 230V IEC/EN 60 947-5-1

Elektrical life

to AC 15

at 3 A, AC 230V: 2 x 10⁵ switching cycl. IEC/EN 60 947-5-1

Short circuit strength

max. fuse rating: 6 A gL IEC/EN 60 947-5-1

Mechanical life:

> 20 x 10⁶ switching cycles

Terminal designation relay:

Prewarning:

Alarm:

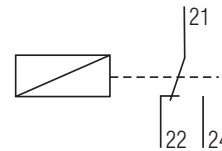
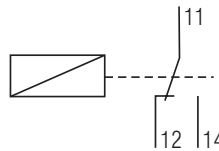

M11062

General Data

Nominal operating mode: continuous operation

Temperature range: -20 ... + 60 °C

Clearance and creepage distance

rated impulse voltage/

pollution degree: 4 kV / 3 IEC 60 664-1

EMC

Electro static discharge (ESD): 8 kV (air) IEC/EN 61000-4-2

HF irradiation: 10 V / m IEC/EN 61000-4-3

Fast transients: 2 kV IEC/EN 61000-4-4

Surge voltage

between

wires for power supply: 2 kV IEC/EN 61 000-4-5

between wire and ground: 4 kV IEC/EN 61 000-4-5

HF-wire guided: 10 V IEC/EN 61 000-4-6

Interference suppression: Limit value class B EN 55 011

Degree of protection

Housing: IP 40 IEC/EN 60 529

Terminals: IP 20 IEC/EN 60 529

Housing: thermoplastic with VO behaviour acc. to UL subject 94

Vibration resistance: Amplitude 0.35 mm

Frequenz 10...55 Hz, IEC/EN 60 068-2-6

20 / 060 / 04

EN 50 005

Wire connection

screw terminals: fixed

max. 4 mm² solid or

2.5 mm² stranded wire with sleeve

min. 0.20 mm²

clamping screw: M2.5

Mounting: DIN-rail IEC/EN 60 715

Weight: approx: ca. 225 g

Dimensions

Width x height x depth: 105 x 90 x 71 mm

Function

Switching output

The device is equipped with a transistor switching output (terminals G, H), which is protected by a series-connected PTC (RN = 220 Ω).

In the idle state, the output is high-resistance. During insulation fault detection, the output is low-resistance (RN) and delivers a low-level in conjunction with a series resistor and an external voltage source.

RS-485 bus connection

The insulation fault locator RR 5887 generally works in slave mode. It synchronises itself independently with the test current output by monitoring the RS485 telegram. All connected insulation fault locators RR 5887 work in parallel and independently from each other.

A bus address can be defined for the device via a rotary switch (RS-485 Bus). If the devices are integrated in an EDS measuring bus system for insulation fault detection, it must be remembered that each insulation fault locator receives its own channel number. An EDS measuring bus master can read insulation fault current values from the connected devices via this channel number.

The bus address of the associated locating current injector RR 5886 can be set via another rotary switch (RR 5886 Channel). A unique reference between a locating current injector and one or several insulation fault locators is established here. This way, several device combinations can be connected jointly to a RS-485 bus and monitor separate networks.

In the absence of an EDS measuring bus connection, the bus address does not have any special significance and be chosen arbitrarily.

The RS-485 LED is permanently on during the insulation fault detection and bus activity and flashes when bus failures occur.

Influence of discharge capacities

The insulation fault locator is also able to perform reliable measurements under the influence of discharge capacities up to a certain size. The influence of discharge capacities depends on the insulation resistance and the mains voltage. Reliable detection of insulation resistance is ensured up to a discharge capacity of 1 µF.

The lower the mains voltage, the greater the permissible discharge capacity may be. For example, with mains voltages of 50 V, 20µF and more can also be processed without problem.

Insulation fault detection is no longer possible if the influence of the discharge capacities becomes too great. The measuring result may become poorer, in addition, when the discharge capacities are distributed unevenly in the network.

However, the symmetry relationships of the insulation fault resistances themselves do not affect the quality of the measurement.

If insulation faults are present between several conductors and PE, mains compensation currents flow through the insulation fault resistances overlaying the actual insulation fault currents. The measured insulation fault current can be reduced by half here in the extreme case.

Current transformer calibration

Current transformer calibration is performed after switching on the device or after pushing the "Alarm reset/ Test/ Transformer calibration" push-button to compensate tolerances of the magnetic material of the current transformers and the resulting differences of the magnetic amplification.

Insulation fault measurement in mixed networks

If an alternating current network, containing a downstream rectifier, is monitored, insulation fault detection can also be performed in the direct voltage circuit if the discharge capacities in this circuit are not too high. Because fault detection can be performed simultaneously in two different network forms – alternating current network and direct current network – the indications displayed for prewarning and alarm are quantitatively valid only for the network form set with the rotary switch. The network form not set will deliver results deviating by the factor 2. However, they can still be analysed in terms of their tendency, i.e. a potential insulation fault is still indicate.

Insulation fault current display

The locating current injector takes the power for the test current from the monitored network itself. Insulation fault current measurements are nearly identical both for AC and DC networks. However, a difference in the level of the test current is obtained through the network form itself. With AC networks, the test current is only half the value as with DC networks. With 3AC networks, the factor is 0.67. These differences are taken into account when determining the level of the insulation fault current and with the display of the alarm values.

Indication of alarm- and states

Indication of alarm states

The display of an alarm state as well as the response of the corresponding common alarm signalling relay act at least for the duration of a measuring cycle (12 sec). The alarm state is cancelled again when the respective threshold of the insulation fault current, under consideration of a defined hysteresis, is fallen below again.

The switching terminal "ALARM MEMORY" must be equipped if the alarm state shall persist permanently.

The response threshold for the insulation fault current does not depend on the network form chosen.

Prewarning

Response threshold: 1 mA
Indication: yellow LED continuously on
Common alarm relay: Collective signalling relay "Prewarning" responds
Hysteresis for return: 0.1 mA
Duration of the alarm state: Until response threshold if fallen below

Alarm

Response threshold: 5 mA
Indication: rote LED leuchtet dauer-rot
Common alarm relay: Collective signalling relay "Alarm" responds
Hysteresis for return: 0.5 mA
Duration of the alarm state: Until response threshold if fallen below

No insulation faults present

Indication: The yellow LED briefly (200 ms) lights after the measuring cycle has been completed

Display of current transformer faults

The insulation fault locator does not feature any control elements for setting the completion of current transformers. For this reason, the device must detect the presence of transformers independently. This happens together with the transformer calibration after switching on the device or after pushing the "Alarm Rest/ Test/ Transformer calibration" button.

The device can detect both, a transformer short circuit and a broken supply line (open transformer contact) individually for each channel.

The check for transformer faults is cyclically repeated after an insulation fault measurement has been completed allowing a transformer fault to be detected also under ongoing operation.

Short circuit at current transformer

Indication: red LED flashes
Duration of indication: Until the short circuit is resolved

Indication detected/interrupted differential current transformer

Indication: yellow LED flashes
Duration of indication: Until current transformer test is completed or open current transformer connection is closed again

Indication of invalid insulation fault measurements

If the value determined for the insulation fault current is invalid, e.g. because of excessive discharge capacities, or the direction of line routing through the current transformer is wrong, this condition is also indicated.

Indication: yellow LED flashes
Duration of indication: Until a valid measured value is determined again or the line direction through the transformer was turned around

Indication of alarm- and function states

Summary: Indication of alarm- and function states

Operation	State of transducer	Insulation failure current I _{fs}	Indication
Measuring operation	Transducer connection ok	Prewarning: I _{fs} > 1 mA	yellow LED continuously on
		Alarm: I _{fs} > 5 mA	red LED continuously on
		no Insulation failure: I _{fs} < 1 mA	yellow LED Briefly lights at the end of the measuring cycle
		Messwert ungültig	yellow LED flashes
	short circuit at transducer		red LED flashes
Transducer Test/ calibration	breaking at transducer		yellow LED flashes
	Transducer not connected		No indication
	Transducer connection		red LED flashes
	Transducer detected		yellow LED flashes

Standard Type

RR 5887.12 AC/DC 85 ... 265 V

Article number: 0065012

- Rated current range for insulation test currents: 1 ... 5 mA
- Maximum test current output: 6.5 mA
- Response sensitivity: 0.5 mA
- Prewarning (Hysteresis: 0.1 mA): 1.0 mA
- Alarm (Hysteresis: 0.5 mA): 5.0 mA
- Width: 105 mm

Ordering example

RR 5887 .12 / 00_

Number of measuring channels:
0: 4-channel
1: 8-channel

Contacts

Type

Accessories

Differential current transformer: ND 5017/024

- The differential current transformer ND5017/024 is designed for DIN rail mounting or screw-type mounting
- Mounting on the top-hat rail may be done horizontally or vertically

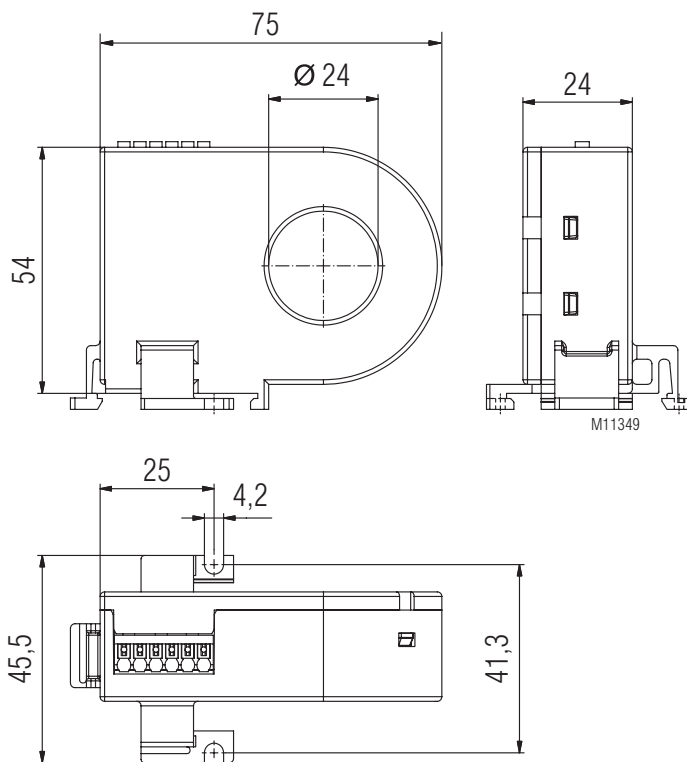

Technical Data

Rated voltage:	500 V
Rated nominal voltage:	1 A
Rated transformation ratio:	1 : 3000
Burden:	180 Ω
Rated frequency:	40 ... 65 Hz
Temperature range:	-20 ... + 60 °C
Rated impulse voltage/ pollution degree:	4 kV / 3
Housing:	thermoplastic with VO behaviour acc. to UL subject 94
Vibration resistance:	Amplitude 0.35 mm frequency 10...55 Hz, IEC/EN 60 068-2-6 20 / 060 / 04
Climate resistance:	
Wire connection	
Single wire	up to 1 m
≥ 0.75 mm ² :	up to 10 m
≥ 0.75 mm ² twisted:	up to 25 m
Cable shield ≥ 0.5 mm ² :	up to 25 m (Shield on one side on I-conductor and not to be earthed)
Weight:	97 g

Dimensions

Width x height x depth: 105 x 90 x 71 mm

Connection Example

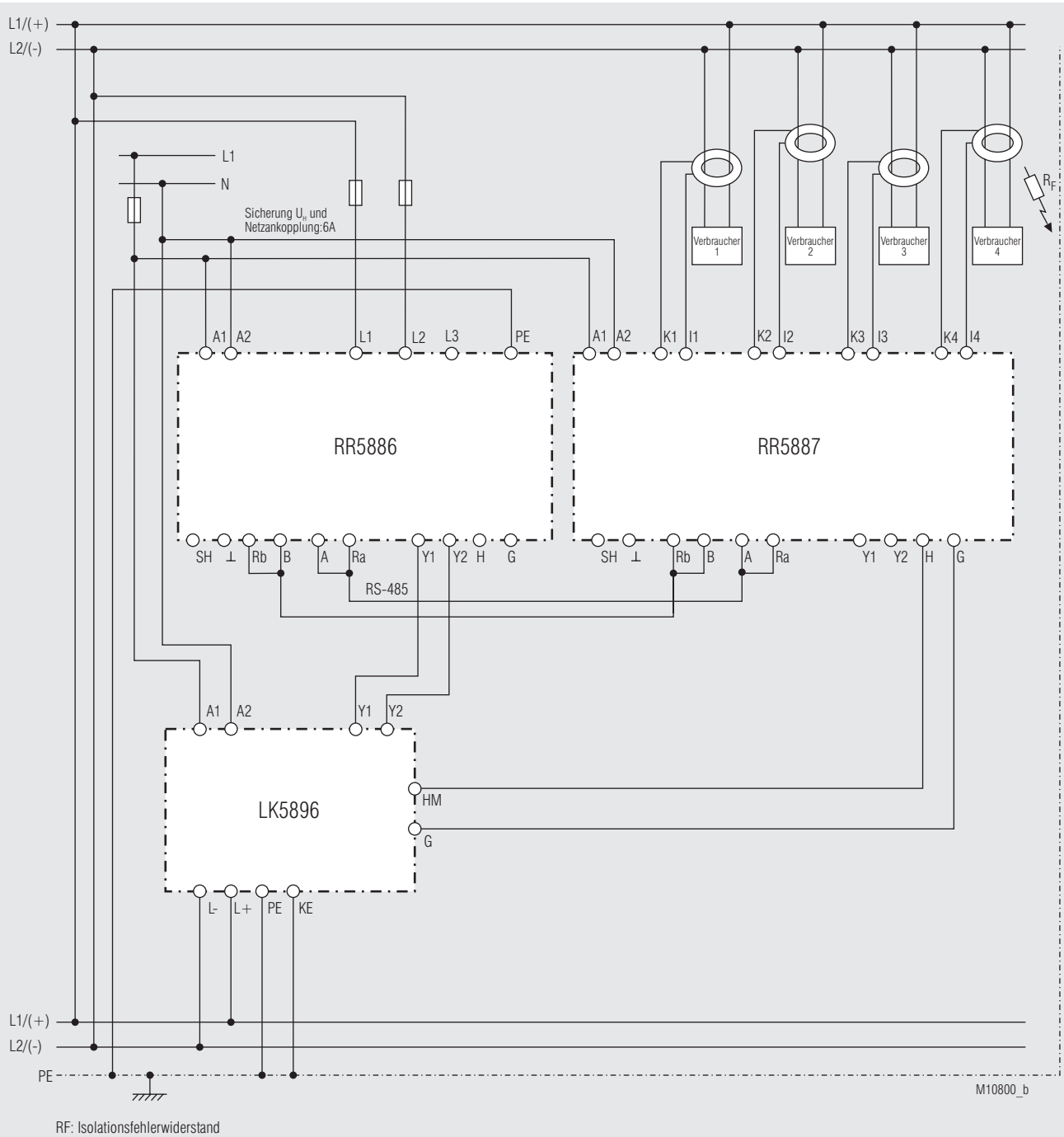

Insulation monitoring and insulation fault detection with 4 connected differential current transformers in a DC/AC network with subdistribution - insulation fault detection can be controlled by the insulation monitor /LK 5896); ALARM MEMORY active, i.e. alarm states are stored; bus termination of the first and last device on the RS-485 bus.

System overview

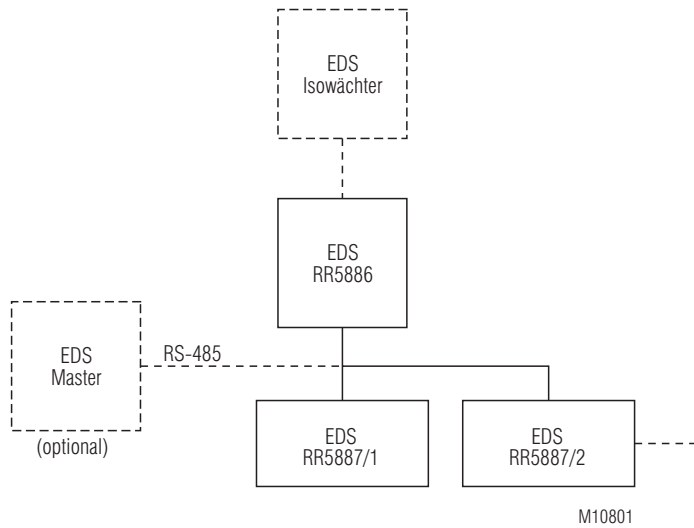

M10801

- Insulation fault detection in DC / AC / 3AC IT networks in connection with the locating current injector RR 5886
- External selection via an insulation monitoring device possible

Connection to measuring bus /Profibus gateway

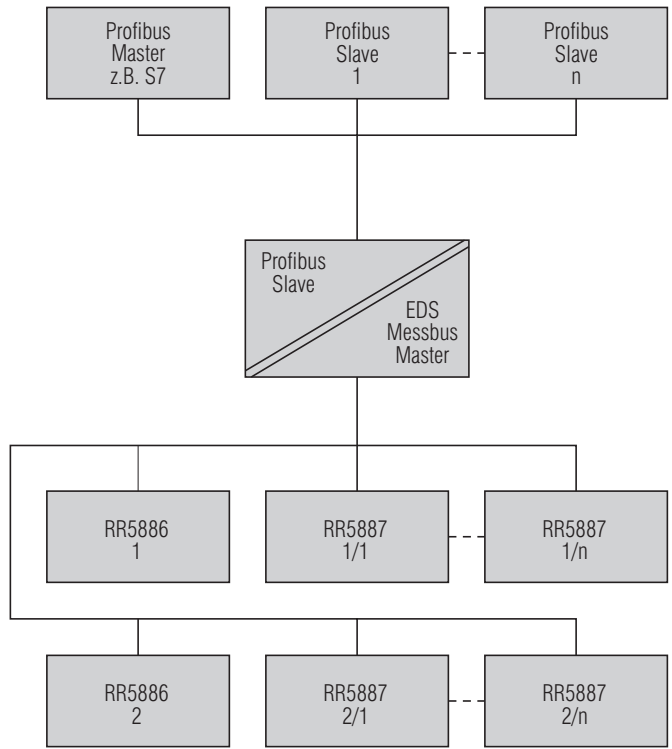

M11061