

### Your Advantages

- Without sensor and safe
- Fast reaction time
- Easy to retrofit
- Combined with Interlock SAFEMASTER STS

### Features

- **According to**
  - Performance Level (PL) e und category 4 to EN ISO 13849-1: 2008
  - SIL-Claimed Level (SIL CL) 3 to IEC/EN 62061
  - Safety Integrity Level (SIL) 3 to IEC/EN 61508 and IEC/EN 61511
- Safe standstill detection on 3- and single-phase motors
- No external sensors necessary
- Independent of direction
- Broken wire detection
- Forcibly guided safety contacts:
  - 3 NO contacts, 1 NC contact for AC 250 V
- 2 semiconductor monitoring outputs
- 1 monitoring output (NO contact)
- Adjustable voltage setting
- Adjustable standstill time delay
- LED indicators for standstill, event of line breakage and operation voltage
- Suitable for operation with inverters
- Width 45 mm

### Function Diagramm

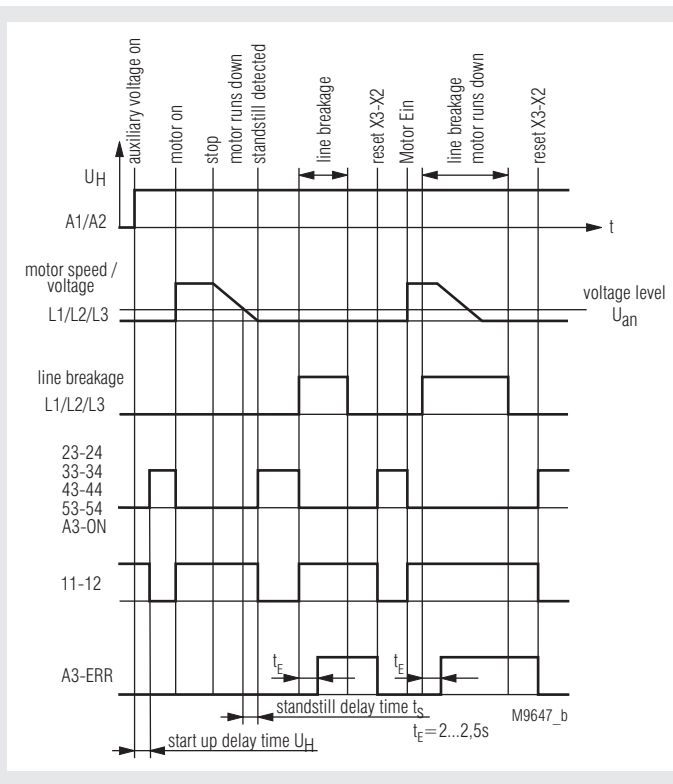

### Approval and Markings



### Applications

Safe standstill detection on 3- and single-phase motors, e.g. to enable gate interlocks on machine tools or to activate hold in brakes.

### Function

The Standstill monitor LH5946 is suitable to monitor the standstill of all electric motors that generate a remanence voltage while coasting to stop. The LH 5946 is connected to the motor terminals and measures the induced back emf voltage. 2 redundant measuring channels are used (L2-L1 and L3 L1). If the back emf voltage drops to 0 simultaneously in both channels this indicates standstill and the output relay is energized.

To adopt the unit to all different types of motors and applications the voltage threshold indicating standstill on LH 5946 is adjustable. Also the time delay between detection and energisation of the relay is adjustable (standstill time  $t_s$ ).

In addition the unit detects broken wire on the measuring inputs L1 / L2 / L3. If broken wire is detected the output relays goes into safe state (as with running motor). This state is stored and can be reset by bridging terminals X3-X2.

The input signals of both channels are permanently compared. If the signals are different for more then 2.5 sec a simultaneity failure is detected. This failure resets when both input channels receive simultaneous signals with a level, above the voltage threshold and hysteresis.

To the terminals X1-X2 the feedback circuit of external contactors (used for contact reinforcement) is connected (NC contact). If no feedback circuit is required, these terminals must be linked. Open terminals will cause a failure message.

### Notes

The terminals X1 - X2 - X3 has no galvanic separation to the measuring circuit L1 - L2 - L3. They must be controlled with volt free contacts.

### Flashing Codes

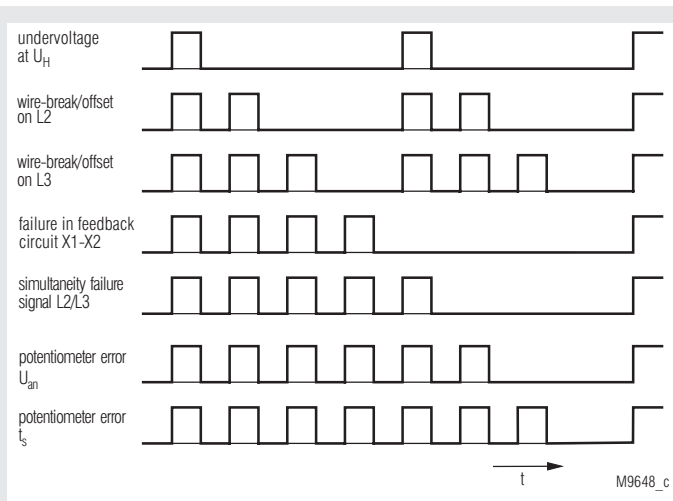

Flashing codes of the LED „ERR“ in sequence of priority

## Circuit Diagram

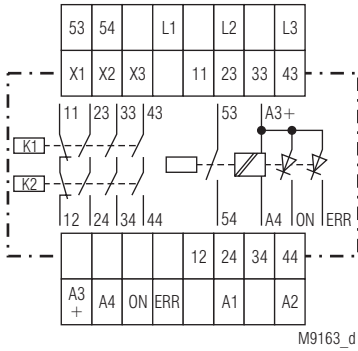

## Connection terminals

Terminal designation	Signal designation
L1 - L2 - L3	Connection to monitored motor
11 - 12	Safety contacts (NC)
23 - 24, 33 - 34, 43 - 44	Safety contacts (NO)
53 - 54	Monitoring contact (NO)
X1 - X2	Connection of feedback circuit (for external contactors)
X2 - X3	Manual reset for external faults
A1 - A2	Auxiliary supply ( $U_H$ )
A3(+)- A4	Supply for semiconductor outputs
ON:	Semiconductor output indicates state of safety contacts
ERR:	Semiconductor output indicates failures

**Attention: The outputs 53-54, ON and ERR are only monitoring outputs and must not be used in safety circuits!**

## Indicators

green-red LED „UH“:	green on, when operation red on, with internal error
yellow-green LED „OUT“:	yellow on, at $EMK > U_{an}$ flashes green at time progression of $t_s$ permanent on, when output contacts are enable
red LED „ERR“:	flashes at error in measuring and feedback circuit and low auxiliary voltage $U_H$ (see flashing codes)

## Technical Data

### Input (L1 - L2 - L3)

<b>Measuring-/Motor voltage:</b>	max. AC 690 V
<b>Input resistance:</b>	500 k $\Omega$
<b>Response value <math>U_{an}</math>:</b>	20 mV ... 400 mV, adjustable or 0.2 ... 4 V, adjustable

### Response value dependent on frequency

Input frequency (Hz):	50	100	200	400	600	1k	1,5 k	2k
Multiplication factor for $U_{an}$ :	1,0	1,1	1,2	1,5	2,0	2,8	5	8

### Hysteresis (for detection of running motor):

100 %

### Release delay for detection of running motor:

< 100 ms

### Standstill time delay $t_s$ :

0.2 ... 6 s adjustable

### Auxiliary voltage $U_H$ (A1 - A2):

AC 115 V, AC 230 V, AC 400 V, DC 24 V

### Recommended fusing:

2 A

### Voltage range

AC:	0.8 ... 1.1 $U_N$
DC:	0.9 ... 1.2 $U_N$
<b>Nominal consumption:</b>	5 VA, $\frac{1}{3}$ W

### Nominal frequency (AC):

50 / 60 Hz

### Frequency range (AC):

45 ... 65 Hz

### max. residual ripple (DC):

10 %

### Start up delay when connecting $U_H$ at standstill:

0,4 ... 0,8 s + adjustable  $t_s$

## Output

### Contacts

#### (safety contacts)

LH 5946.48:

3 NO contacts, 1 NC contact  
relay, positive guide

#### Contact type:

AC 250 V

#### Nominal output voltage:

#### Thermal current $I_{th}$ :

5 A (bis 40°C)

#### Quadratic total current:

see derating curve

#### Switching capacity

to AC 15

NO contact:

3 A / AC 230 V

IEC/EN 60 947-5-1

NC contact

2 A / AC 230 V

IEC/EN 60 947-5-1

to DC 13

NO contact:

1 A / DC 24 V

IEC/EN 60 947-5-1

NC contact

1 A / DC 24 V

IEC/EN 60 947-5-1

to DC 13

NO contact:

4 A / 24 V at 0.1 Hz IEC/EN 60 947-5-1

NC contact

4 A / 24 V at 0.1 Hz IEC/EN 60 947-5-1

#### Fusing of the safety contacts:

max. fuse rating 4AgL  
line circuit breaker C6A  
1200 / h

#### Max. operating frequency:

#### Contact service life

at AC 230 V / 5 A  $\cos\varphi = 0.5$ :

$\geq 2 \times 10^5$  switching cycles

#### Mechanical life:

$\geq 50 \times 10^6$  switching cycles

### Semiconductor monitoring output:

100 mA DC 24 V, plus switching,  
galvanic separation; supply via  
A3+ / A4 for output; „ON“ and „ERR“

### NO monitoring contact:

3 A AC 250 V (closed when enabled)

**Technical Data****General Data**

<b>Nominal operating mode:</b>	continuous operation	
<b>Temperature range</b>		
operation:	- 25 ... + 60°C (+ 40°C with max. contact current, see Derating)	
storage:	- 40 ... + 75°C	
<b>Altitude:</b>	< 2.000 m	
<b>Clearance and creepage distance</b>		
rated impulse voltage / pollution degree:	IEC 60 664-1	
Contacts 11/12, 23/24, 33/34, 43/44 against all others:	6 kV / 2	
Contacts 11/12, 23/24, 33/34, 43/44 against each others:	4 kV / 2	
Indicator contact 53/54 against all others:	4 kV / 2	
Semiconductor outputs A3+/ ON / ERR / A4 against all others:	6 kV / 2	
Auxiliary voltage A1 / A2 against all others		
at auxiliary voltage AC:	6 kV / 2	
at auxiliary voltage DC:	4 kV / 2	
Control terminal X1 / X2 / X3:	no galvanic separation to L1 / L2 / L3	
<b>EMC</b>		
Electrostatic discharge (ESD):	8 kV (air)	IEC/EN 61 000-4-2
HF irradiation:	20 V/m	IEC/EN 61 000-4-3
Fast transients: surge voltage between measuring input L1 / L2 / L3: wires for power supply A1 / A2 at AC - U <sub>H</sub> : at DC 24 V: HF-wire guided: Interference suppression:	2 kV 2 kV 1 kV 10 V limit value class B	IEC/EN 61 000-4-4 IEC/EN 61 000-4-5 IEC/EN 61 000-4-5 IEC/EN 61 000-4-6 EN 55 011
<b>Degree of protection</b>		
Housing:	IP 40	IEC/EN 60 529
Terminals:	IP 20	IEC/EN 60 529
<b>Enclosure:</b>	thermoplastic with VO behaviour according to UL subject 94	
<b>Vibration resistance:</b>	amplitude 0.35 mm frequency 10 ... 55 Hz, IEC/EN 60 068-2-6 25 / 060 / 04 IEC/EN 60 068-1	
<b>Climate resistance:</b>	EN 50 005	
<b>Terminal designation:</b>	DIN 46 228-1/-2/-3/-4	
<b>Wire connection</b>	60°C Copper conductors only	
<b>UL detail:</b>		
<b>Screw terminals (integrated):</b>	1 x 4 mm <sup>2</sup> solid or 1 x 2.5 mm <sup>2</sup> stranded ferruled or 2 x 1.5 mm <sup>2</sup> stranded ferruled or 2 x 2.5 mm <sup>2</sup> solid	
Insulation of wires or sleeve length:	8 mm	
<b>Plugin with screw terminals</b>		
max. cross section for connection:	1 x 2.5 mm <sup>2</sup> solid or 1 x 2.5 mm <sup>2</sup> stranded ferruled	
Insulation of wires or sleeve length:	8 mm	
<b>Plugin with cage clamp terminals</b>		
max. cross section for connection:	1 x 4 mm <sup>2</sup> solid or 1 x 2.5 mm <sup>2</sup> stranded ferruled	
min. cross section for connection:	0.5 mm <sup>2</sup>	
Insulation of wires or sleeve length:	12 ±0.5 mm	
<b>Wire fixing:</b>	Plus-minus terminal screws M 3.5 box terminals with wire protection or cage clamp terminals	
<b>Mounting:</b>	DIN-rail IEC/EN 60 715	
<b>Weight:</b>	approx. 400 g	

**Dimensions**

**Width x height x depth:** 45 x 90 x 121 mm

**Technical Data****Safety Related Data****Values according to EN ISO 13849-1:**

Category:	4	
PL:	e	
MTTF <sup>d</sup> :	93	a
DC <sup>avg</sup> :	99.0	%
d <sub>op</sub> :	365	d/a (days/year)
h <sub>op</sub> :	24	h/d (hours/day)
t <sub>Zyklus</sub> :	28.8E+03	s/Zyklus
	≥ 1	/8 h (hours)

**Values according to IEC/EN 62061 / IEC/EN 61508 / IEC/EN 61511:**

SIL CL:	3	IEC/EN 62061
SIL	3	IEC/EN 61508 / IEC/EN 61511
HFT <sup>1)</sup> :	1	
DC <sup>avg</sup> :	99.0	%
SFF:	99.7	%
PFH <sub>D</sub> :	4.10E-10	h <sup>-1</sup>
PFD:	1,42E-04	
T <sub>i</sub> :	20	a (year)

<sup>1)</sup> HFT = Hardware-Failure Tolerance



The values stated above are valid for the standard type.  
Safety data for other variants are available on request.

The safety relevant data of the complete system has to be  
determined by the manufacturer of the system.

**UL-Data**

**The safety functions were not evaluated by UL. Listing is accomplished according to requirements of Standard UL 508, "general use applications"**

**Auxiliary voltage U<sub>H</sub>**

for DC 24 V: Device must be supplied with a Class 2 or  
a voltage / current limited power supply  
(max. 4 A).

**Measuring-/Motor voltage:** max. AC 600 V

**Ambient temperature:** - 25 ... + 60°C, (+ 40°C with max. contact  
current, see Derating)

**Switching capacity**

safety contacts  
(11/12, 23/24, 33/34, 43/44)  
Ambient temperature 40°C: Pilot duty B300  
5A 250Vac G.P.  
5A 24Vdc G.P.

Ambient temperature 60°C: Pilot duty B300  
2A 250Vac G.P.  
2A 24Vdc G.P.

**Switching capacity**

indicator contact (53/54) 3A 250Vac G.P.

**Wire connection:**

Fixed screw terminal: 60°C / 75°C copper conductors only  
1 x AWG 20 - 12 Sol/Str Torque 0.8 Nm or  
2 x AWG 20 - 14 Sol/Str Torque 0.8 Nm

Plugin screw terminal: AWG 20 - 14 Sol Torque 0.8 Nm or  
AWG 20 - 18 Str Torque 0.8 Nm

Plugin cage clamp terminal: AWG 20 - 12 Sol/Str



**Technical data that is not stated in the UL-Data, can be found  
in the technical data section.**

### Standard Type

- LH 5946.48/61 20 ... 400 mV UH DC 24 V 0.2 ... 6 s  
 Article number: 0059266
- Safety output: 3 NO contacts, 1 NC contact
  - Response value  $U_{an}$ : 20 ... 400 mV
  - Auxiliary voltage  $U_H$ : DC 24 V
  - Standstill time  $t_s$ : 0.2 ... 6 s
  - 1 semiconductor and 1 NO contact for indicator output
  - 1 semiconductor for fault indicator output
  - Width: 45 mm

### Ordering Example

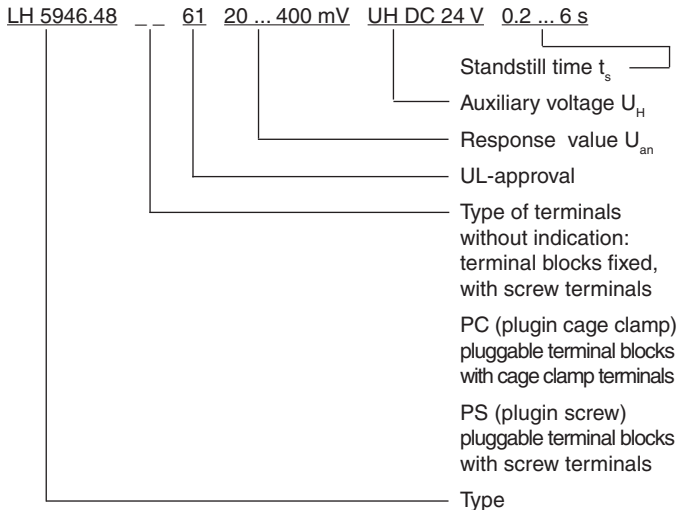

### Options with Pluggable Terminal Blocks

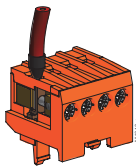

Screw terminal (PS/plugin screw)

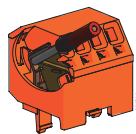

Cage clamp terminal (PC/plugin cage clamp)

### Notes

Removing the plugin terminal blocks

1. The unit has to be disconnected.
2. Insert a screwdriver in the side recess of the front plate.
3. Turn the screwdriver to the right and left.
4. Please note that the terminal blocks have to be mounted on the belonging plug in terminations.

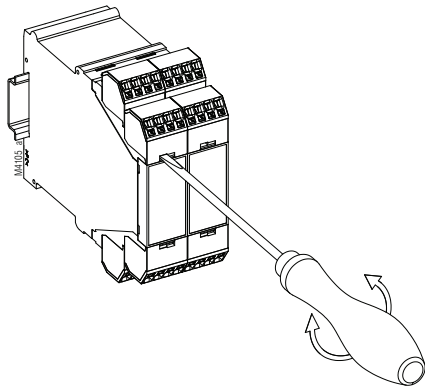

### Characteristic

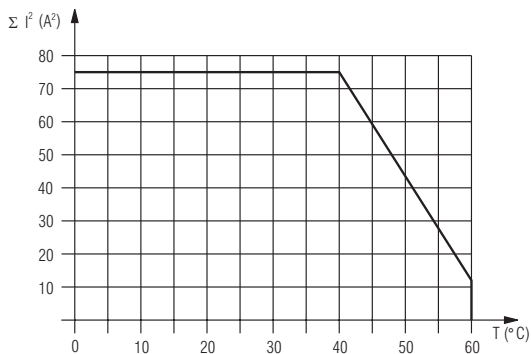

Quadratic total current

$$\Sigma = I_1^2 + I_2^2 + I_3^2$$

$I_1, I_2, I_3$  - current in contact paths

max. permitted current up to 40°C on 3 contact paths = 5A

$$(5^2 + 5^2 + 5^2 = 75A^2)$$

max. permitted current up to 60°C on 3 contact paths = 2A

$$(2^2 + 2^2 + 2^2 = 12A^2)$$

Derating curve for contact currents of safety contacts

## Application Examples

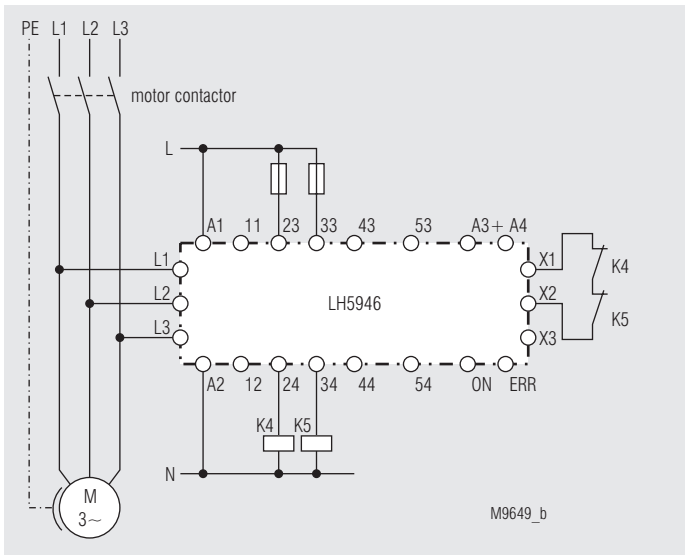

With 3-phase motor; suitable up to SIL3, Performance Level e, Cat. 4

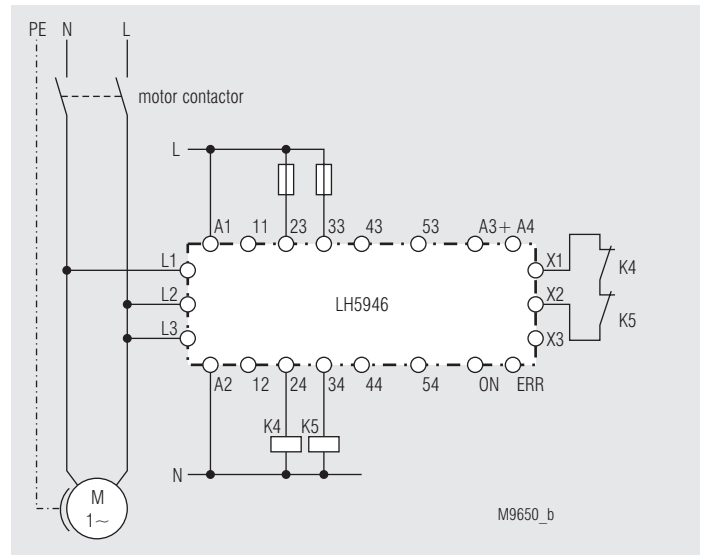

With single-phase motor; suitable up to SIL3, Performance Level e, Cat. 4

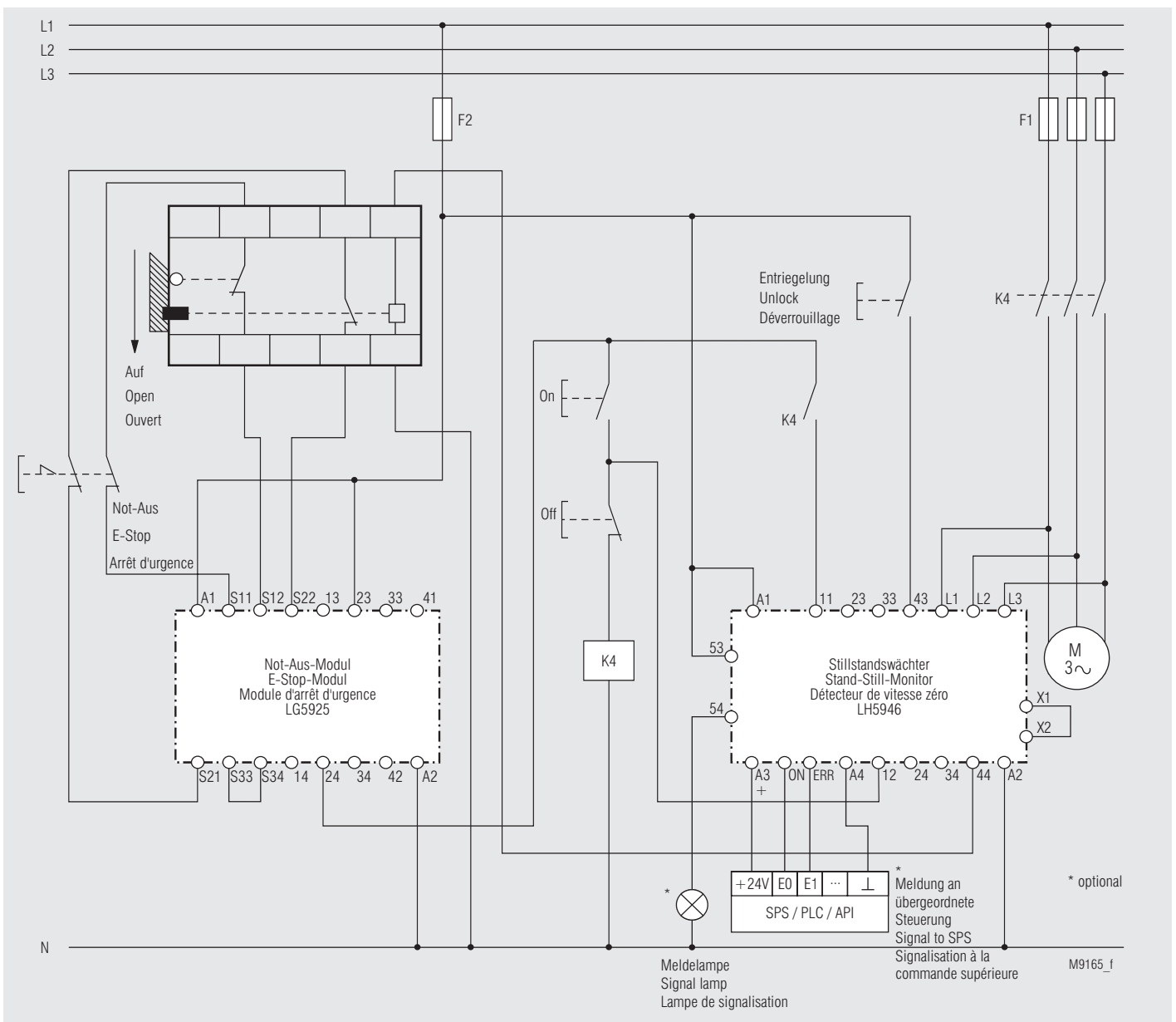

Typical connection combination with E-Stop; suitable up to SIL3, Performance Level e, Cat. 4

## Application Examples

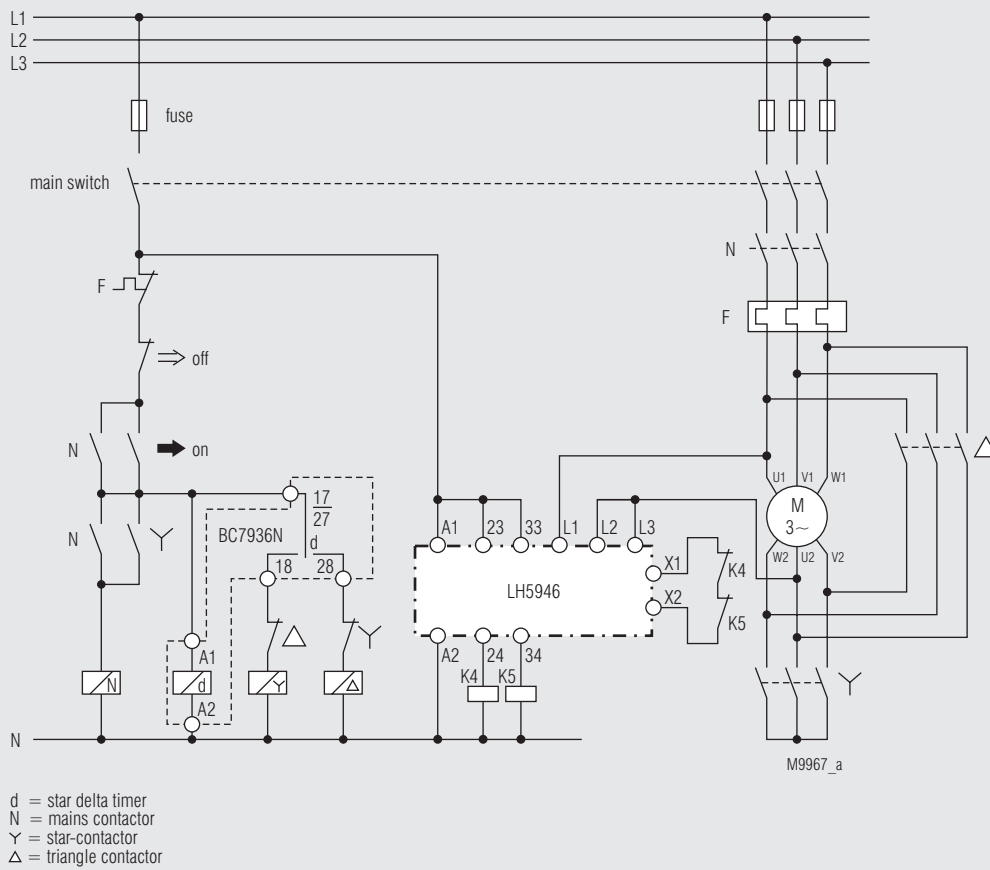

Typical connection combination with star delta timer, 2-channel connection of the measuring inputs; suitable up to SIL3, Performance Level e, Cat. 4

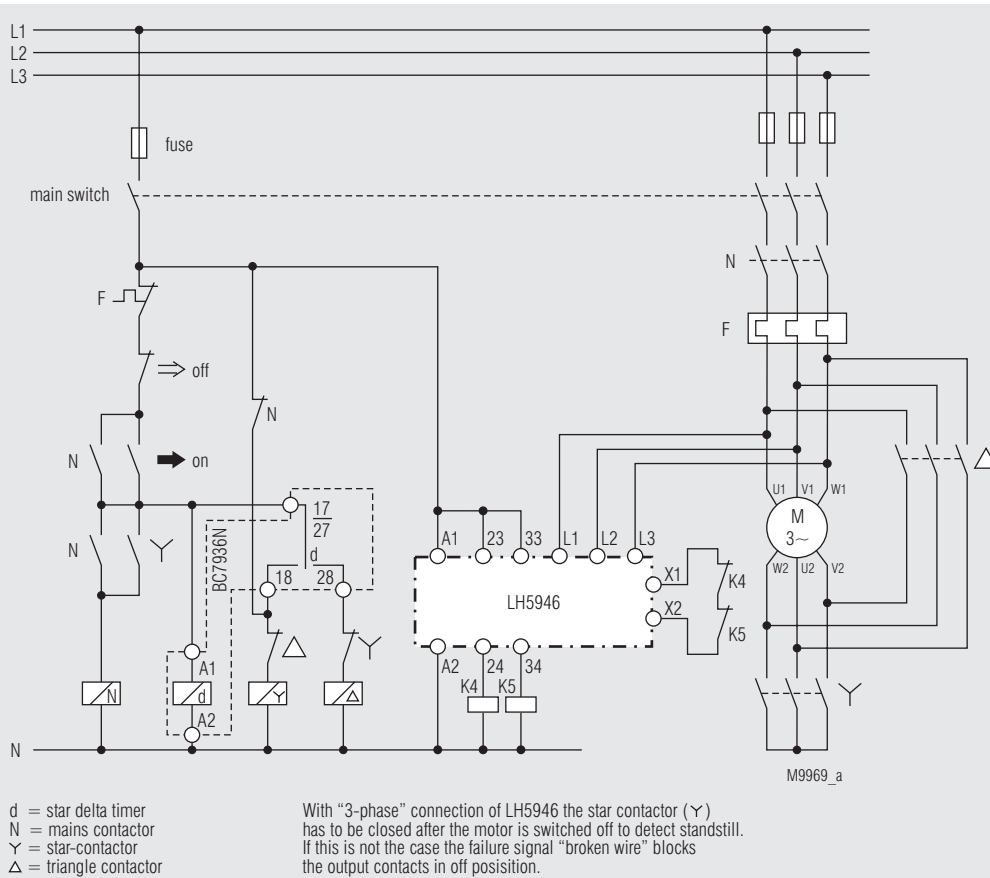

Typical connection combination with star delta timer, 3-channel connection of the measuring inputs; suitable up to SIL3, Performance Level e, Cat. 4