

light source

- work equipment**
- connected load**
- Power consumption**
- luminous flux**
- luminous efficacy**
- light distribution**
- colour temperature**
- color rendering index (CRI)**
- glare control**
- System of protection**
- class of protection**
- technology**
- operation**
- luminaire body**

- lamp cover**
- weight (net)**
- mains supply**

- design**
- Fastening**
- dimension**
- special features**

LED

- Energy efficiency category A/A+/A++
- without
- 22-26 V; DC
- approx. 5 W
- approx. 630 lm
- approx. 126 lm/W
- direct
- neutral white, approx. 5000 K
- >= 80
- screen
- IP54
- III
- multi-stage switchable
- external
- aluminium/plastic, anodised; painted, aluminium coloured
- anodised
- Acrylic satine
- approx. 0.2 kg
- built-in plug
- M12-A-5
- mounted version
- bracket
- A=335mm, C=290mm, C1=320mm
- ADVANCED package, through-wired



M12-A-5

illuminance

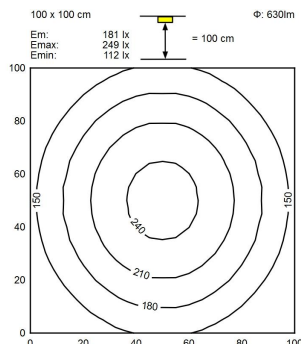

luminous intensity

