

Solid State Relays

1-Phase, Proportional Switching Controllers

Types RGS1P..AA., RGS1P..V..



- 1-pole analog switching AC solid state relays
- Selectable mode of operation:
 - Phase Angle
 - Full Cycle x1, x4, x16
 - Advanced Full Cycle
 - Soft Starting
- Rated operational voltage: up to 660 VAC
- Rated operational current: up to 90 AAC
- Control inputs: 4-20 mA, 0-5V, 1-5V, 0-10V, external potentiometer
- Integrated varistor protection on output
- Load ON LED indication
- 100kA short circuit current rating according to UL508



Product Description

The RGS1P is a series of solid state relays that give the possibility to control output power of 1-phase loads with an analog control input. The RGS1P is intended to be mounted on chassis or an external heatsink.

phase angle control, full cycle control, advanced full cycle control specific for short wave infrared heaters and soft starting for limiting inrush current of loads having a high temperature coefficient.

Input types cover a wide range of current and voltage ranges. Local setting by an external potentiometer is possible. Switching modes, selectable through a front knob, allow

The output of the RGS1P is protected against overvoltages by means of an integrated varistor across the output. Two front LEDs indicate the status of the load and control.

Specifications are at a surrounding temperature of 25°C unless otherwise specified.

Ordering Key

RGS 1 P 60 V 50 E D

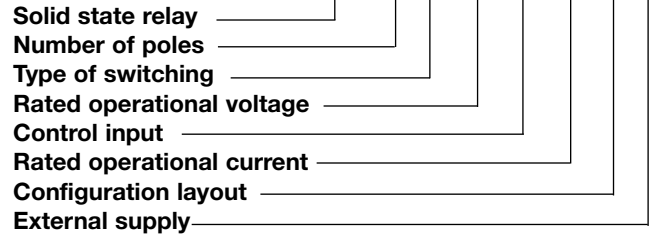

Type Selection

SSR with no heatsink	Type of switching	Rated voltage (Ue), Blocking voltage	Control input ¹	Rated current ² @40°C, I _{rt}	Connection configuration	External supply (Us)
RGS1: 1-pole switching	P: Proportional	23: 85 - 265 VAC, 800 Vp	AA: 4-20 mADC	50: 50 AAC, 1,800 A ² s 92: 90 AAC, 18,000 A ² s	E: Contactor	D: 24 VDC/AC A: 90 - 250 VAC
		48: 190 - 550 VAC, 1200 Vp	V: 0-5 VDC 1- 5 VDC			
		60: 410 - 660 VAC, 1200 Vp	0-10 VDC External potentiometer			

1: 'V' control input versions require an external supply Us

2: Max. ratings with suitable heatsink. Refer to Heatsink Selection tables for further details.

Selection Guide

Output voltage, Ue	Control input	External supply, Us	Power connection	Rated operational current (I _t value) Product width	
				50 AAC (1,800 A ² s) 35 mm	90 AAC (18,000 A ² s) 35 mm
85 - 265 VAC	AA: 4-20 mA DC	-	Screw	RGS1P23AA50E	-
			Box	-	RGS1P23AA92E
	V: 0-10V, 0-5V, 1-5VDC, pot	24 VDC/AC	Screw	RGS1P23V50ED	-
			Box	-	RGS1P23V92ED
		90-250 VAC	Screw	RGS1P23V50EA	-
			Box	-	RGS1P23V92EA
190 - 550 VAC	AA: 4-20 mA DC	-	Screw	RGS1P48AA50E	-
			Box	-	RGS1P48AA92E
	V: 0-10V, 0-5V, 1-5VDC, pot	24 VDC/AC	Screw	RGS1P48V50ED	-
			Box	-	RGS1P48V92ED
		90-250 VAC	Screw	RGS1P48V50EA	-
			Box	-	RGS1P48V92EA
410 - 660 VAC	AA: 4-20 mA DC	-	Screw	RGS1P60AA50E	-
			Box	-	RGS1P60AA92E
	V: 0-10V, 0-5V, 1-5VDC, pot	24 VDC/AC	Screw	RGS1P60V50ED	-
			Box	-	RGS1P60V92ED
		90-250 VAC	Screw	RGS1P60V50EA	-
			Box	-	RGS1P60V92EA

General Specifications

	RGS1P..AA	RGS1P..V	
Operational frequency range	45 to 65 Hz	45 to 65 Hz	
Power factor	> 0.7 @ rated voltage	> 0.7 @ rated voltage	
Touch Protection	IP20	IP20	
LED status indication ³			
	Green	Control input <4 mA, flashing 0.5s ON, 0.5s OFF >4 mA, intensity varies with input Supply ON (Us) n/a	Control input <0 V, flashing 0.5s ON, 0.5s OFF >0 V, fully ON Supply ON (Us) Flashing 0.5s ON, 0.5s OFF
	Yellow	Load ON	Load ON
Pollution degree	2 (non-conductive pollution with possibilities of condensation)	2 (non-conductive pollution with possibilities of condensation)	
Over-voltage category	III (fixed installations)	III (fixed installations)	
Isolation			
L1, T1, A1, A2, A3, POT, GND, Us to case	4000 Vrms	4000 Vrms	
L1, T1 to A1, A2, A3, Pot, GND, Us	2500 Vrms	2500 Vrms	
Us to A1, A2, A3, POT, GND	n/a	n/a (..V..ED) 1500 Vrms (..V..EA)	

3: Refer to LED Indications section

Output Voltage Specifications

	RGS1P23..	RGS1P48..	RGS1P60..
Operational voltage range (Ue)	85-265 VAC	190-550 VAC	410-660 VAC
Blocking voltage	800 Vp	1200 Vp	1200 Vp
Leakage current @ rated voltage	≤ 5 mAAC	≤ 5 mAAC	≤ 5 mAAC
Internal Varistor across output	Yes	Yes	Yes

Output Specifications

	RGS1P..50	RGS1P..92
Rated operational current per pole ⁴		
AC-51	50 AAC	90 AAC
AC-55b ⁵	50 AAC	90 AAC
Minimum operational current	250 mAAC	500 mAAC
Rep. Overload Current PF = 0.7 UL508: T=40°C, tON=1s, tOFF=9s, 50cycles	107 AAC	168 AAC
Maximum transient surge current (I _{tsm}), t=10ms	600 Ap	1900 Ap
I ² t for fusing (t=10ms), minimum	1800 A ² s	18000 A ² s
Critical dv/dt (@ T _j init = 40°C)	1000 V/us	1000 V/us

4: Max. current with suitable heatsink. Refer to Heatsink Selection tables.

5: Overload profile for AC-55b, I_e: AC-55b: 6x I_e - 0.2: 50 - x; where I_e = nominal current (AAC), 0.2 is the duration of the overload (6xI_e) in seconds, 50 is the duty cycle in %, and x = no. of starts. RGS1P..50: AC-55b: 180 - 0.2 : 50 - 15; RGS1P..92: AC-55b: 300 - 0.2 : 50 - 350. Consult Carlo Gavazzi representative for other overload current values.

Supply Specifications

	RGS1P..V..D	RGS1P..V..A
Supply voltage range (U _s) ⁶	24 VDC, -15% / +20% 24 VAC, -15% / +15%	90-250 VAC -
Overvoltage protection	up to 32 VDC/AC for 30 sec.	n/a
Reverse Protection	Yes	n/a
Surge Protection ⁷	Yes, integrated	Yes, integrated
Max. supply current	30 mA	14 mA

6. 24 DC / AC to be supplied from a Class 2 power source

7. Refer to Electromagnetic Compatibility section

Input Specifications

	RGS1P..AA	RGS1P..V
Control input	4-20 mADC (A1-GND)	0-10 VDC (A1-GND) 0-5 VDC (A2-GND) 1-5 VDC (A3-GND)
Pickup current, minimum	4.3 mADC	-
Drop out current	3.9 mADC	-
Pick up voltage		
0-5 VDC, 0-10 VDC range	-	0.5 VDC
1-5 VDC range	-	1.5 VDC
Drop out voltage		
0-5 VDC, 0-10 VDC range	-	0.05 VDC
1-5 VDC range	-	1.02 VDC
Potentiometer input	-	10k ohms (GND - A2 - POT)
Maximum initialisation time	280 ms	250 ms
Response time (Input to Output)		
Modes 1, 5, 7	2 half cycles	2 half cycles
Modes 2, 3, 4, 6	3 half cycles	3 half cycles
Voltage drop	<10 VDC @ 20 mA	n/a
Input impedance	n/a	100k ohms
Linearity (Output resolution)	Refer to Transfer Characteristics section, note 9	
Reverse protection	Yes	Yes
Maximum allowable input current	50 mA for max. 30 sec	-
Input protection vs. surges ⁸	Yes	Yes
Overvoltage protection	-	up to 30 VDC

8. Refer to Electromagnetic Compatibility section

9. The RGx1P is intended for use in closed loop systems where the output power automatically adjusts to the control input available from the system.

Transfer Characteristics

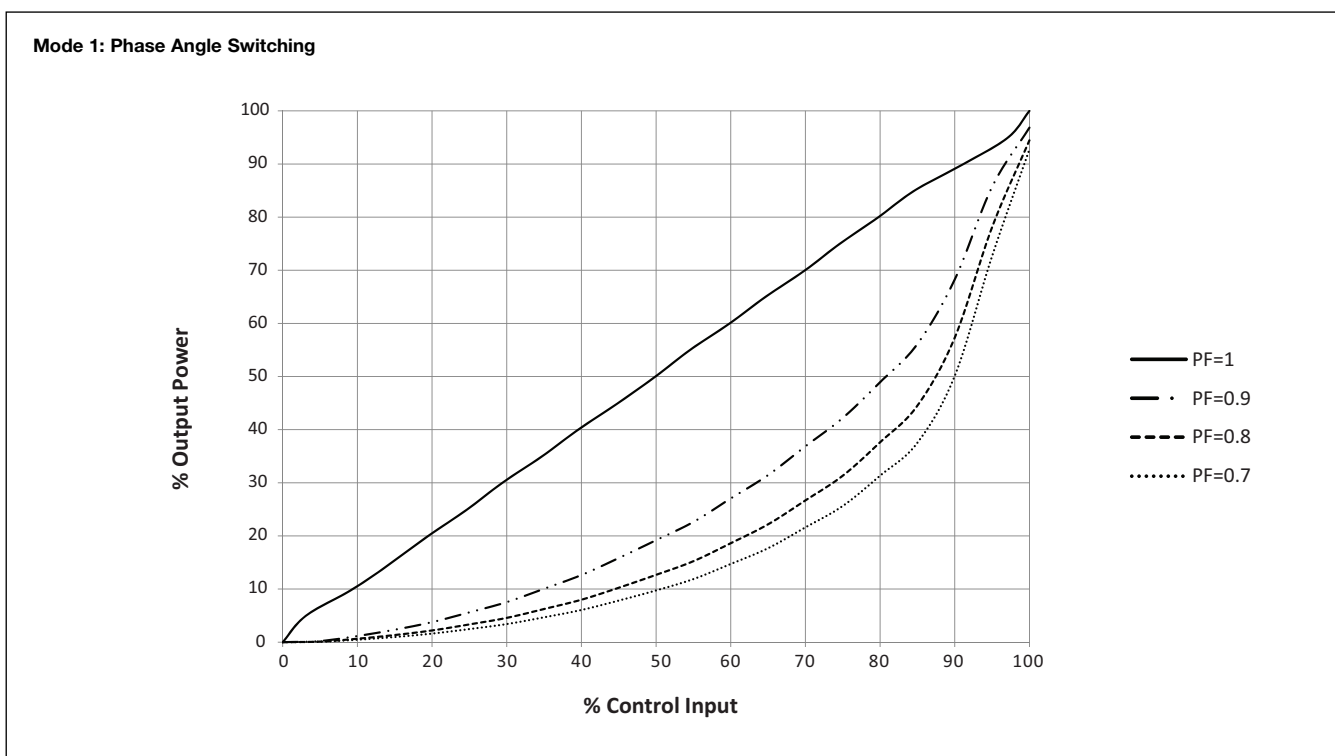

Transfer Characteristics (cont.)

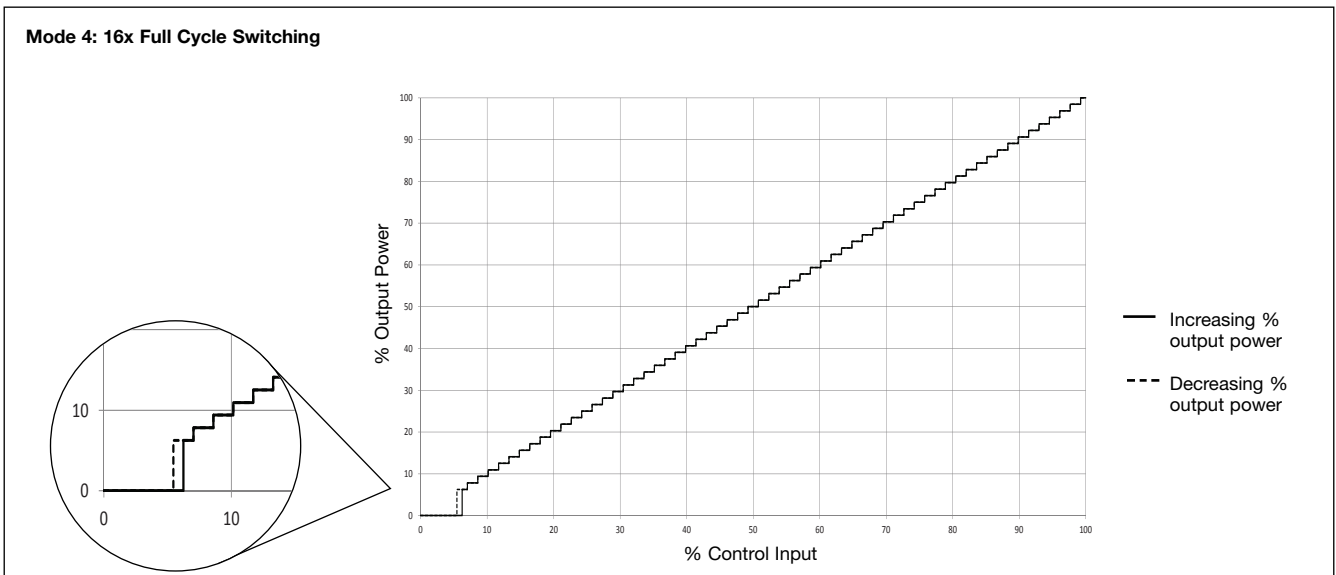
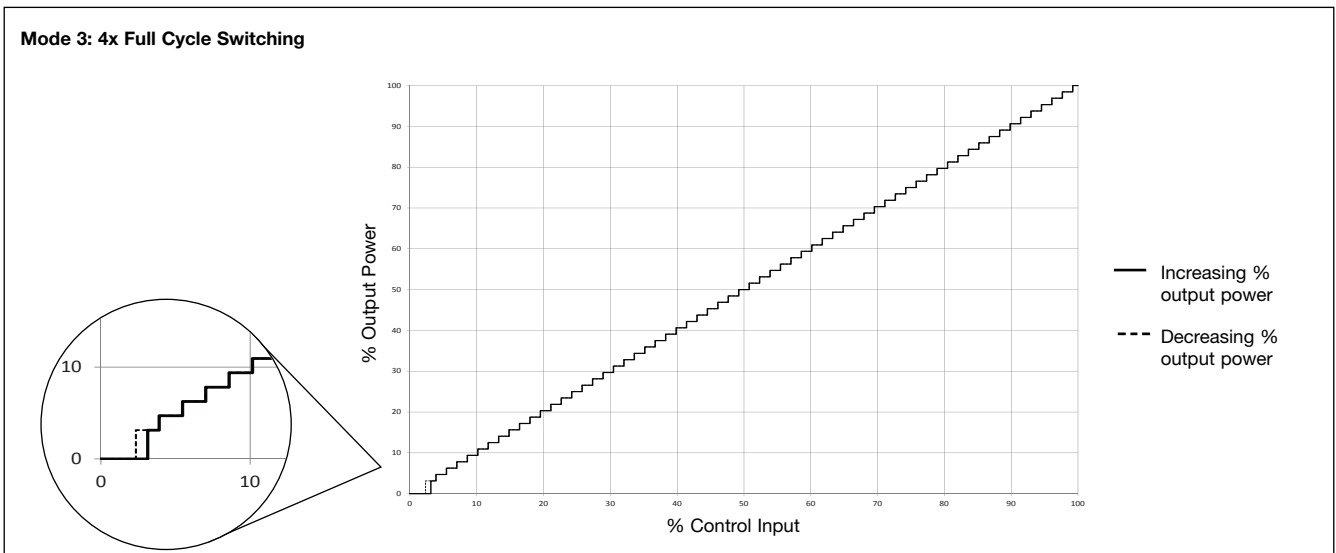
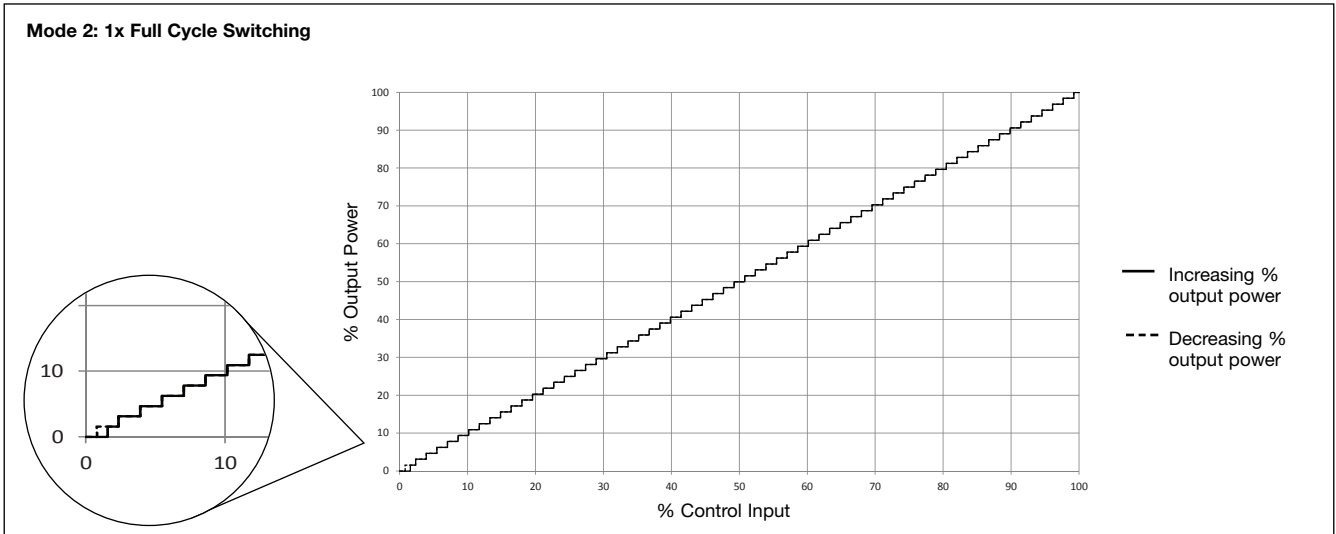

Output Power Dissipation

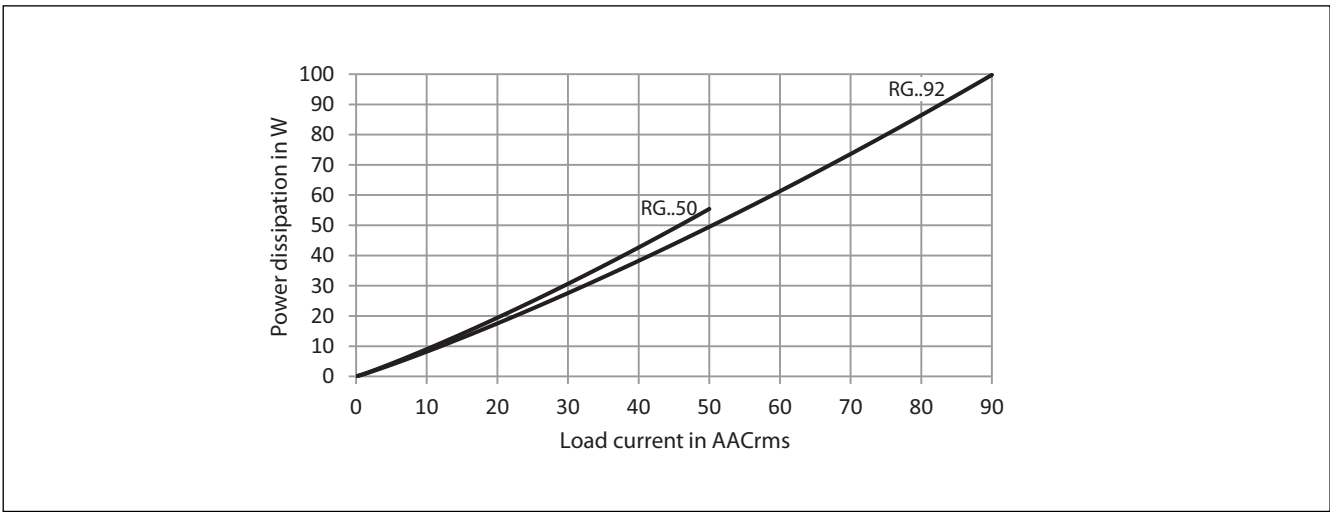

Heatsink Selection

RGS1P..50

Load current [A]	Thermal resistance [°C/W]					
	20	30	40	50	60	70
50.0	1.45	1.28	1.06	0.87	0.68	0.49
45.0	1.72	1.50	1.29	1.07	0.85	0.64
40.0	2.00	1.75	1.50	1.25	1.00	0.75
35.0	2.35	2.06	1.76	1.47	1.18	0.88
30.0	2.83	2.48	2.13	1.77	1.42	1.06
25.0	3.52	3.08	2.64	2.20	1.76	1.32
20.0	4.58	4.01	3.44	2.86	2.29	1.72
15.0	6.40	5.60	4.80	4.00	3.20	2.40
10.0	10.19	8.92	7.64	6.37	5.10	3.82
5.0	---	19.51	16.72	13.94	11.15	8.36

Ambient temp [°C]

RGS1P..92

Load current [A]	Thermal resistance [°C/W]					
	20	30	40	50	60	70
90.0	0.62	0.52	0.41	0.31	0.21	0.11
81.0	0.77	0.66	0.54	0.42	0.31	0.19
72.0	0.97	0.83	0.70	0.56	0.43	0.29
63.0	1.23	1.07	0.91	0.75	0.59	0.43
54.0	1.55	1.35	1.16	0.97	0.77	0.58
45.0	1.93	1.69	1.45	1.21	0.97	0.73
36.0	2.53	2.21	1.89	1.58	1.26	0.95
27.0	3.55	3.11	2.66	2.22	1.77	1.33
18.0	5.67	4.97	4.26	3.55	2.84	2.13
9.0	12.46	10.90	9.34	7.79	6.23	4.67

Ambient temp [°C]

Maximum junction temperature	125°C
Heatsink temperature	100°C
Junction to case thermal resistance, Rthjc	<0.3 °C/W
Case to heatsink thermal resistance, Rthcs ¹⁰	< 0.25 °C/W

Maximum junction temperature	125°C
Heatsink temperature	100°C
Junction to case thermal resistance, Rthjc	<0.20 °C/W
Case to heatsink thermal resistance, Rthcs ¹⁰	< 0.25 °C/W

10: Case to heatsink thermal resistance values indicated are applicable upon application of a fine layer of silicon based thermal paste HTS02S from electrolube between SSR and heatsink or mounting surface.

Environmental and Housing Specifications

Operating Temperature	-40°C to +70°C (-40°F to +158°F)	GWIT & GWFI (for plastic)	conform to EN 60335-1 requirements
Storage Temperature	-40°C to +100°C (-40°F to +212°F)	Installation altitude	0-1000m. Above 1000m derate linearly by 1% of FLC per 100m up to a maximum of 2000m
RoHS (2011/65/EU)	Compliant	Weight	
Impact resistance (EN50155, EN61373)	15/11 g/ms	RGS1P..50	approx. 180g
Vibration resistance (2-100Hz, EN50155, EN61373)	2g per axis	RGS1P..92	approx. 190g
Relative humidity	95% non-condensing @ 40°C		
Material	PA66, RAL7035		
UL flammability rating (for plastic)	UL 94 V0		

Agency Approvals and Conformances

Conformance	IEC/EN 60947-4-3	Agency Approvals	UR: UL508 Recognised, NMFT2 E172877 cUR: CSA 22.2 No.14-13, NMFT8 E172877 CSA: CSA 22.2 No.14-13, 204075
		Short Circuit Current Rating	100kArms, UL508



Electromagnetic Compatibility

EMC Immunity	EN 60947-4-3	Electrical fast transient (Burst) immunity Output: 2kV, 5 kHz RGS1P..AA.. A1, A2: 2 kV, 5 kHz RGS1P..V.. A1, A2, A3, POT, GND: 1 kV, 5 kHz Us: 2 kV, 5 kHz	EN/IEC 61000-4-4 Performance Criteria 1
Electrostatic discharge (ESD) immunity Air discharge, 8 kV Contact, 4 kV	EN/IEC 61000-4-2 Performance Criteria 2 Performance Criteria 2		Performance Criteria 1 Performance Criteria 1
Electrical surge immunity Output, line to line, 1 kV Output, line to earth, 2 kV A1, A2 RGS1P..AA.. Line to line, 500 V Line to earth, 500 V A1, A2, A3, POT, GND RGS1P..V.. Line to earth, 1 kV Us +, Us - RGS1P..V..ED Line to line, 500 V Line to earth, 500 V Us ~ RGS1P..V..EA Line to line, 1 kV Line to earth, 2 kV	EN/IEC 61000-4-5 Performance Criteria 2 Performance Criteria 2 Performance Criteria 2 Performance Criteria 2 Performance Criteria 2 Performance Criteria 2 Performance Criteria 2 Performance Criteria 2 Performance Criteria 2	Radiated radio frequency immunity 10V/m, 80 - 1000 MHz 10V/m, 1.4 - 2.0 GHz 3V/m, 2.0 - 2.7 GHz Conducted radio frequency immunity 10V/m, 0.15 - 80 MHz Voltage Dips 0% for 0.5, 1 cycle 40% for 10 cycles 70% for 25 cycles 80% for 250 cycles Voltage Interruptions 0% for 5000 ms	Performance Criteria 1 Performance Criteria 1 Performance Criteria 1 Performance Criteria 1 Performance Criteria 1 Performance Criteria 1 Performance Criteria 1 Performance Criteria 1 Performance Criteria 1 Performance Criteria 2 Performance Criteria 2 Performance Criteria 2 Performance Criteria 2 Performance Criteria 2 Performance Criteria 2 Performance Criteria 2 Performance Criteria 2
EMC Emission	EN 60947-4-3	Radio interference field emission (radiated) 30 - 1000 MHz	EN/IEC 55011 Class A (industrial)
Radio interference voltage emission (conducted) 0.15 - 30 MHz	EN/IEC 55011 Class A (with external filtering)		

Note:

- Control input lines must be installed together to maintain products susceptibility to Radio Frequency Interference.
 - Use of AC solid state relays may according to the application and the load current, cause conducted radio interferences. Use of mains filters may be necessary for cases where the user must meet E.M.C requirements. The capacitor values given inside the filtering specification tables should be taken only as indications, the filter attenuation will depend on the final application.
 - This product has been designed for Class A equipment. (External filtering may be required, refer to filtering section). Use of this product in domestic environments may cause radio interference, in which case the user may be required to employ additional mitigation methods.
 - Surge tests on RGC..A models were carried out with the signal line impedance network. In case the line impedance is less than 40Ω, it is suggested that AC supply is provided through a secondary circuit where the short circuit limit between conductors and ground is 1500VA or less.
 - A deviation of one step in the distributed full cycle models and up to 1.5% Full Scale Deviation in phase angle models is considered to be within PC1 criteria.
- Performance Criteria 1 (Performance Criteria A): No degradation of performance or loss of function is allowed when the product is operated as intended.
- Performance Criteria 2 (Performance Criteria B): During the test, degradation of performance or partial loss of function is allowed. However, when the test is complete the product should return operating as intended by itself.
- Performance Criteria 3 (Performance Criteria C): Temporary loss of function is allowed, provided the function can be restored by manual operation of the control.

Filtering - EN/IEC 55011 Compliance

Compliance to Class A emission limits

	RGS1P..50..	RGS1P..92..	
	30 AAC	43 AAC	60 AAC
Max. Load Current	SCHAFFNER, FN2410-45-33	SCHAFFNER, FN2410-45-33	
Mode 1 - Phase Angle	EPCOS, SIFI -H-G136	A50R000 EPCOS, A42R12 SIFI-H-G136 (up to 36 AAC)	SCHAFFNER, FN2410-60-34
Mode 2 -1x Full Cycle	2.2uF, max. 760 VAC / X1	3.3uF, max. 760 VAC / X1	3.3uF, max. 760 VAC / X1
Mode 3 - 4x Full Cycle	1uF, max. 760 VAC / X1	2.2uF, max. 760 VAC / X1	2.2uF, max. 760 VAC / X1
Mode 4 - 16x Full Cycle	680nF, max. 760 VAC / X1	1uF, max. 760 VAC / X1	2.2uF, max. 760 VAC / X1
Mode 5 - Advanced full cycle	3.3uF, max. 760 VAC / X1	3.3uF, max. 760 VAC / X1	SCHAFFNER, FN2410-60-34 EPCOS, A60R000
Mode 6 - Soft start + Mode 4	680nF, max. 760 VAC / X1	1uF, max. 760 VAC / X1	2.2uF, max. 760 VAC / X1
Mode 7 - Soft start + Mode 5	3.3uF, max. 760 VAC / X1	3.3uF, max. 760 VAC / X1	SCHAFFNER, FN2410-60-34 EPCOS, A60R000

Compliance to Class B emission limits

	RGS1P..50..	RGS1P..92..	
	30 AAC	43 AAC	60 AAC
Max. Load Current	EPCOS, A42R1122	EPCOS, A55R122	EPCOS, A75R122
Mode 1 - Phase Angle	SCHAFFNER, FN2410-45-33	SCHAFFNER, FN2410-45-33 ROXBURGH, MDF50	SCHAFFNER, FN2410-60-34
Mode 2 - 1x Full Cycle	EPCOS, SIFI-H-G136	A50R000 EPCOS, A42R122 SIFI-H-G136 (up to 36 AAC)	EPCOS, A60R000
Mode 3 - 4x Full Cycle	3.3uF, max. 760 VAC / X1	3.3uF, max. 760 VAC / X1	SCHAFFNER, FN2410-60-34 EPCOS, A60R000
Mode 4 - 16x Full Cycle	2.2uF, max. 760 VAC / X1 SCHAFFNER, FN2410-45-33	2.2uF, max. 760 VAC / X1 SCHAFFNER, FN2410-45-33 ROXBURGH, MDF50	3.3uF, max. 760 VAC / X1 SCHAFFNER, FN2410-60-34
Mode 5 - Advanced full cycle	EPCOS, SIFI-H-G136	A50R000 EPCOS, A42R122 SIFI-H-G136 (up to 36 AAC)	EPCOS, A60R000
Mode 6 - Soft start + Mode 4	2.2uF, max. 760 VAC / X1 SCHAFFNER, FN2410-45-33	2.2uF, max. 760 VAC / X1 SCHAFFNER, FN2410-45-33 ROXBURGH, MDF50	3.3uF, max. 760 VAC / X1 SCHAFFNER, FN2410-60-34
Mode 7 - Soft start + Mode 5	EPCOS, SIFI-H-G136	A50R000 EPCOS, A42R122 SIFI-H-G136 (up to 36 AAC)	EPCOS, A60R000

Filter Connection Diagram

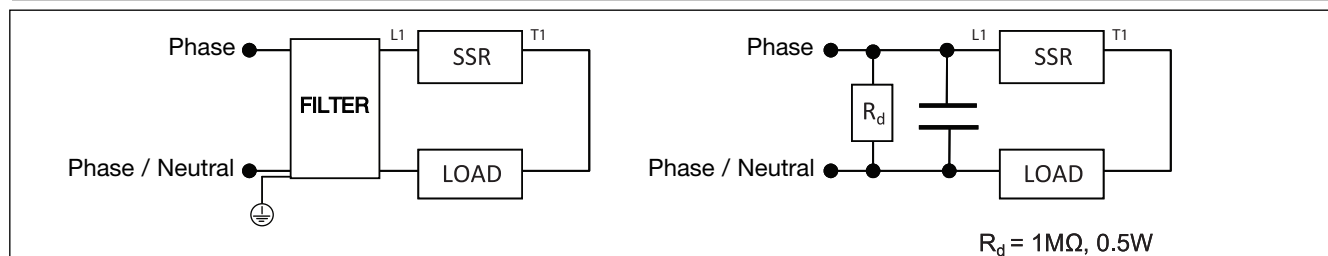

Note: The suggested filtering is determined by tests carried out on a representative setup and load. The RGS1P. is intended to be integrated within a system where conditions may differentiate from conditions utilised for tests, such as load, cable lengths and other auxiliary components that may exist within the end system. It shall be the responsibility of the system integrator to ensure that the system containing the above component complies with the applicable rules and regulations.

Filter manufacturer installation recommendations shall be taken in consideration when utilising such filters.

Product Interface

RGS1P..AA..

Terminals Labelling:

1/L1: Line connection
 2/T1: Load connection
 A1 - A2: Control input: 4 - 20 mA

RGS1P..V..

Terminals Labelling:

1/L1: Line connection
 2/T1: Load connection
 A1-GND: Control input: 0-10V
 A2-GND: Control input: 0-5V
 A3-GND: Control input: 1-5V
 POT: External potentiometer input
 Us (+, -): External supply, positive signal (RG..V.D) or AC signal (RG..V.A)
 Us (-, -): External supply, ground (RG..V.D) or AC signal (RG..V.A)

Ramp up time setting for soft starting, applicable for Modes 6 and 7 only

Mode Selection	Switching Mode
	1 Phase Angle (default setting)
	2 1x Full Cycle
	3 4x Full Cycles
	4 16x Full Cycles
	5 Advanced Full Cycle
	6 Soft start + 16x Full Cycles
	7 Soft start + Advanced Full Cycle

LED Indications

RGS1P..AA..

LED	Status	Timing Diagram
CONTROL (green)	Control input <4mA	[Pulsed signal]
	Control input >4mA	[Solid signal]
	Mains loss	[Pulsed signal with 0.5s delay]
	SSR internal error	[Pulsed signal with 0.5s delay and 3s pulse]
LOAD (yellow)	LOAD ON	[Solid signal]

RGS1P..V..

LED	Status	Timing Diagram
CONTROL (green)	Supply voltage (Us) ON	[Pulsed signal]
	Control input >0V	[Solid signal]
	Mains loss	[Pulsed signal with 0.5s delay]
	SSR internal error	[Pulsed signal with 0.5s delay and 3s pulse]
LOAD (yellow)	LOAD ON	[Solid signal]

Switching Modes

Firing periods Non-firing periods

MODE 1: Phase angle switching

The Phase angle switching mode works in accordance with the phase angle control principle. The power delivered to the load is controlled by the firing of the thyristors over each half mains cycle. The firing angle depends on the input signal level that determines the output power to be delivered to the load.

Output with Phase angle switching mode @ 50% input level:

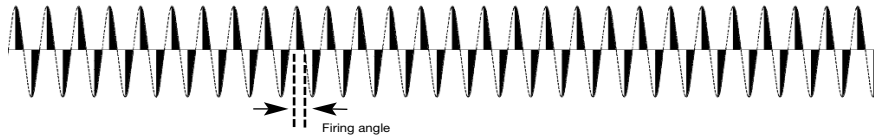

Full cycle switching

In Full cycle switching modes only full cycles are being switched. Switching at zero voltage reduces EMC interference as compared to phase angle switching (mode 1). The ON full cycles are distributed over a specific time base. Compared to burst firing, this enables faster and more accurate control of the load in addition to extending the heater lifetime. This mode is suitable for use only with resistive loads.

MODE 2: 1x Full cycle switching

This mode offers the lowest resolution for full cycle switching, i.e., 1 full cycle. At 50% output power demand the SSR will switch ON the load for 1 full cycle and OFF for 1 full cycle in a repeated pattern. Below 50% output power demand, the non-firing period increases but the firing period remains fixed at 1 full cycle. Over 50% output power demand, the firing period increases but the non-firing period remains fixed at 1 full cycle.

Hence at 25% output power demand, the non-firing period gets longer and the SSR will switch ON the load for 1 full cycle and OFF for 3 full cycles in a repeated pattern. At 75% output power demand, the firing period is longer and the SSR will switch ON the load for 3 full cycles and OFF for 1 full cycle in a repeated pattern. At 100% output power demand, the SSR switches the load fully ON.

Output with 1 FC switching mode @ 25% input level:



Output with 1 FC switching mode @ 50% input level:

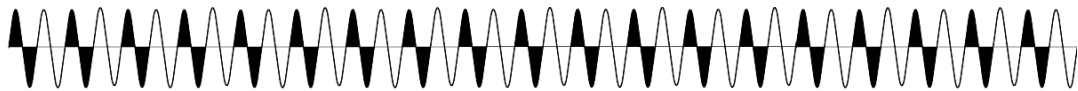

Output with 1 FC switching mode @ 75% input level:



Output with 1 FC switching mode @ 100% input level:

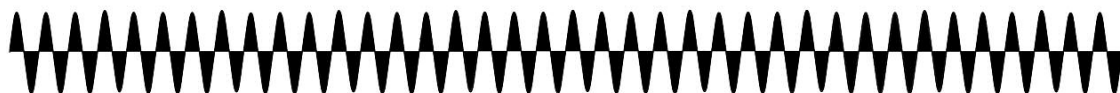

Switching Modes

MODE 3: 4x Full cycle switching

MODE 4: 16x Full cycle switching

In **mode 3** the minimum resolution is 4 full cycles. At 50% output power demand the SSR will switch ON the load for 4 full cycles and OFF for 4 full cycles in a repeated pattern. Below 50% output power demand, the non-firing period increases but the firing period remains fixed at 4 full cycles. Over 50% output power demand, the firing period increases but the non-firing period remains fixed at 4 full cycles.

In **mode 4** the minimum resolution is 16 full cycles. At 50% output power demand the SSR will switch ON the load for 16 full cycles and OFF for 16 full cycles in a repeated pattern. Below 50% output power demand, the non-firing period increase but the firing period remains fixed at 16 full cycles. Over 50% output power demand the firing period increases but the non-firing period remains fixed at 16 full cycles.

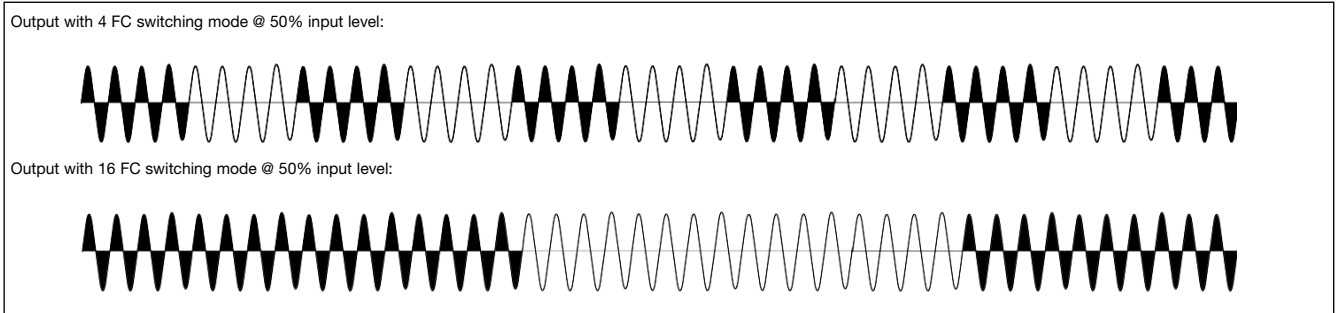

MODE 5: Advanced Full Cycle (AFC) switching

This switching mode is based on the principle of distributed full cycle explained above with the difference that the resolution for firing and non-firing periods is changed to a half mains cycle. This mode is intended for use with short / medium wave infrared heaters. The purpose of the half cycle non-firing time is to reduce the annoying visual flickering of such lamp loads.

Below 50% output power demand, the SSR switches ON the load in half cycle periods. The non-firing periods are full cycles. Above 50% output power demand, the SSR switches ON the load in full cycle periods but the non-firing periods are half cycles.



SOFT STARTING

Soft starting is utilised to reduce the start-up current of loads having a high cold to hot resistance ratio such as short wave infrared heaters. The thyristor firing angle is gradually increased over a time period of maximum 5 seconds (settable through an accessible potentiometer) in order to apply the voltage (and current) to the load smoothly.

Soft starting is performed on the first power up and in cases of non firing periods exceeding 5 seconds. If soft start is stopped before soft start completion, it is assumed that a start was performed and the non firing period count start as soon as the soft start is stopped.

Switching Modes

MODE 6: Soft start + MODE 4 (16x full cycle switching)

This switching mode works on the principle of switching mode 4 (16x full cycles) but soft starting is performed on power up or in case of the non firing periods exceeding 5 seconds. After the soft start is completed, full cycles (with a resolution of 16 full cycles) are delivered to the load according to the input signal, based on MODE 4 switching principle.

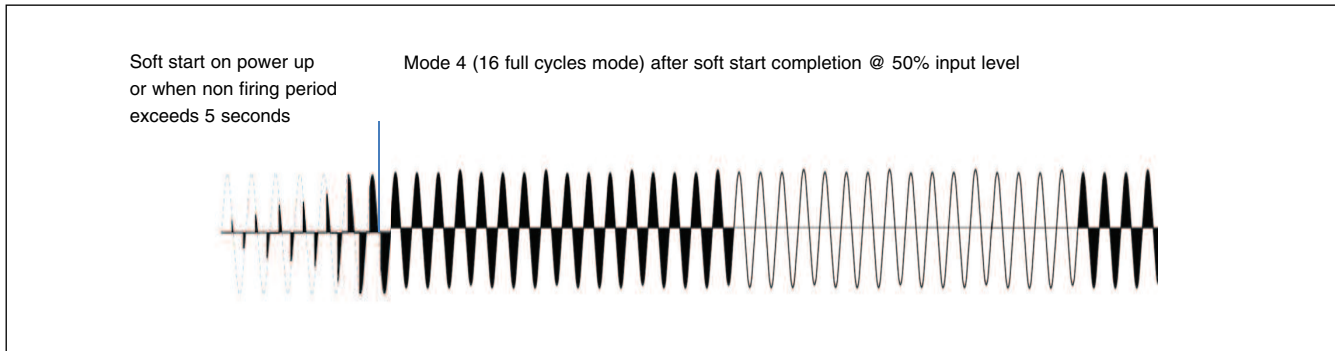

MODE 7: Soft start + MODE 5 (Advanced full cycle switching)

This switching mode works on the principle of the advanced full cycle (mode 5) but soft starting is performed on power up or in case of the non firing periods exceeding 5 seconds. After the soft start is completed, output power is delivered to the load according to the input signal, based on Mode 5 switching principle.

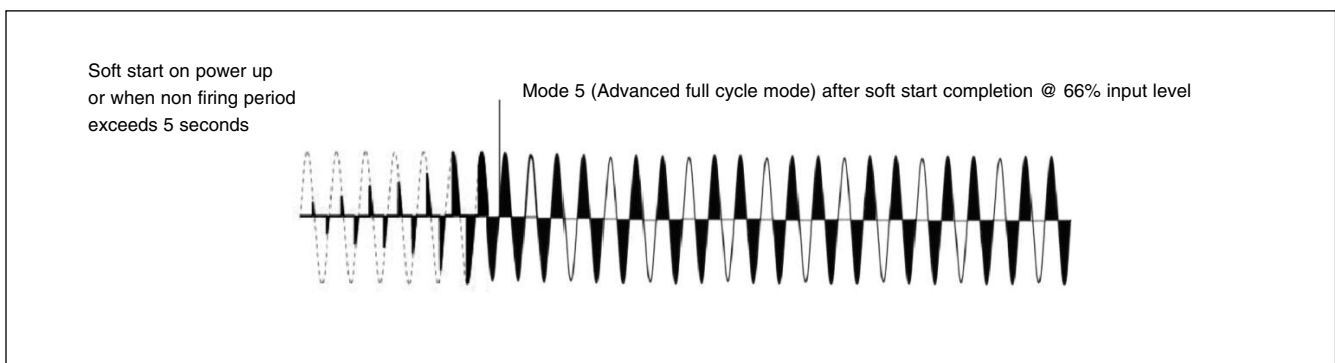

Dimensions

RGS1P..50

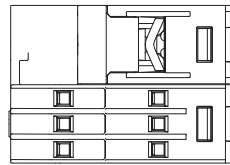
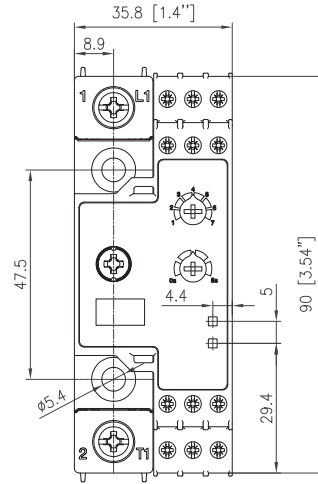
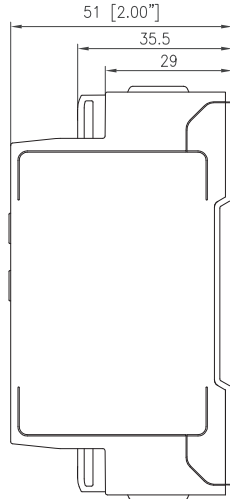
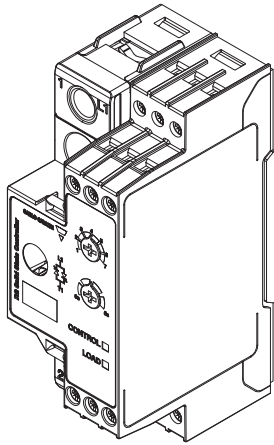

Note: The indicated depth dimension of the RGx1P has to be increased by 3mm when the tamper proof cover accessory is mounted on the device.

Housing width tolerance +0.5mm, -0mm... as per DIN43880.
All other tolerances ± 0.5 mm.
All dimensions in mm.

RGS1P..92

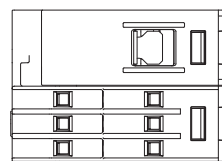
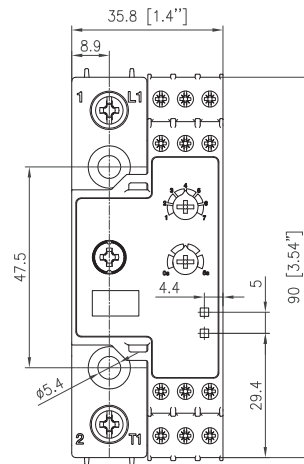
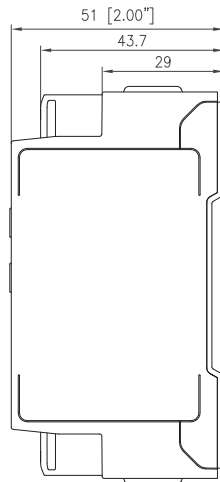
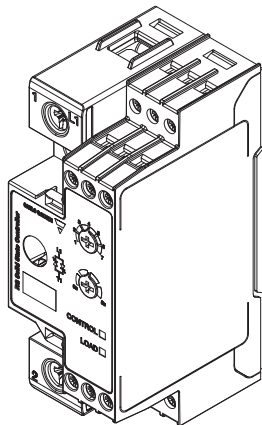







Note: The indicated depth dimension of the RGx1P has to be increased by 3mm when the tamper proof cover accessory is mounted on the device.

Housing width tolerance +0.5mm, -0mm... as per DIN43880.
All other tolerances ± 0.5 mm.
All dimensions in mm.

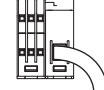
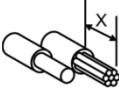
Connection Specifications



POWER CONNECTIONS

		1/L1, 2/T1		
		RGS..50		RGS..92
Use 75°C copper (Cu) conductors				
				
Stripping length (X)		12mm		11mm
Connection type		M4 screw with captivated washer		M5 screw with box clamp
Rigid (solid & stranded)		2x 2.5 - 6.0 mm ² 2x 14 - 10 AWG	1x 2.5 - 6.0 mm ² 1x 14 - 10 AWG	1x 2.5 - 25 mm ² 1x 14 - 3 AWG
UL/CSA rated data				
Flexible with end sleeve		2x 1.0 - 2.5 mm ² 2x 2.5 - 4.0 mm ² 2x 18 - 14 AWG 2x 14 - 12 AWG	1x 1.0 - 4.0 mm ² 1x 18 - 12 AWG	1x 2.5 - 16 mm ² 1x 14 - 6 AWG
Flexible without end sleeve		2x 1.0 - 2.5 mm ² 2x 2.5 - 6.0 mm ² 2x 18 - 14 AWG 2x 14 - 10 AWG	1x 1.0 - 6.0 mm ² 1x 18 - 10 AWG	1x 4.0 - 25 mm ² 1x 12 - 3 AWG
Torque specification		Pozidriv 2 UL: 2Nm (17.7 lb-in) IEC: 1.5-2.0Nm (13.3-17.7 lb-in)		Pozidriv 2 UL: 2.5Nm (22 lb-in) IEC: 2.5-3.0Nm (22-26.6 lb-in)
Aperture for termination lug		12.3mm		n/a

CONTROL CONNECTIONS

Use 60/75°C copper (Cu) conductors

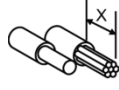
GND, A1, A2, A3, POT, Us

			
Stripping length (X)		8 mm	
Connection type		M3 screw with box clamp	
Rigid (solid & stranded)		1x 1.0 - 2.5 mm ² 1x 18 - 12 AWG	
UL/CSA rated data			
Flexible with end sleeve		1x 0.5 - 2.5 mm ² 1x 20 - 12 AWG	
Torque specification		Pozidriv 1 UL: 0.5Nm (4.4 lb-in) IEC: 0.4-0.5Nm (3.5-4.4 lb-in)	

Connection Diagram

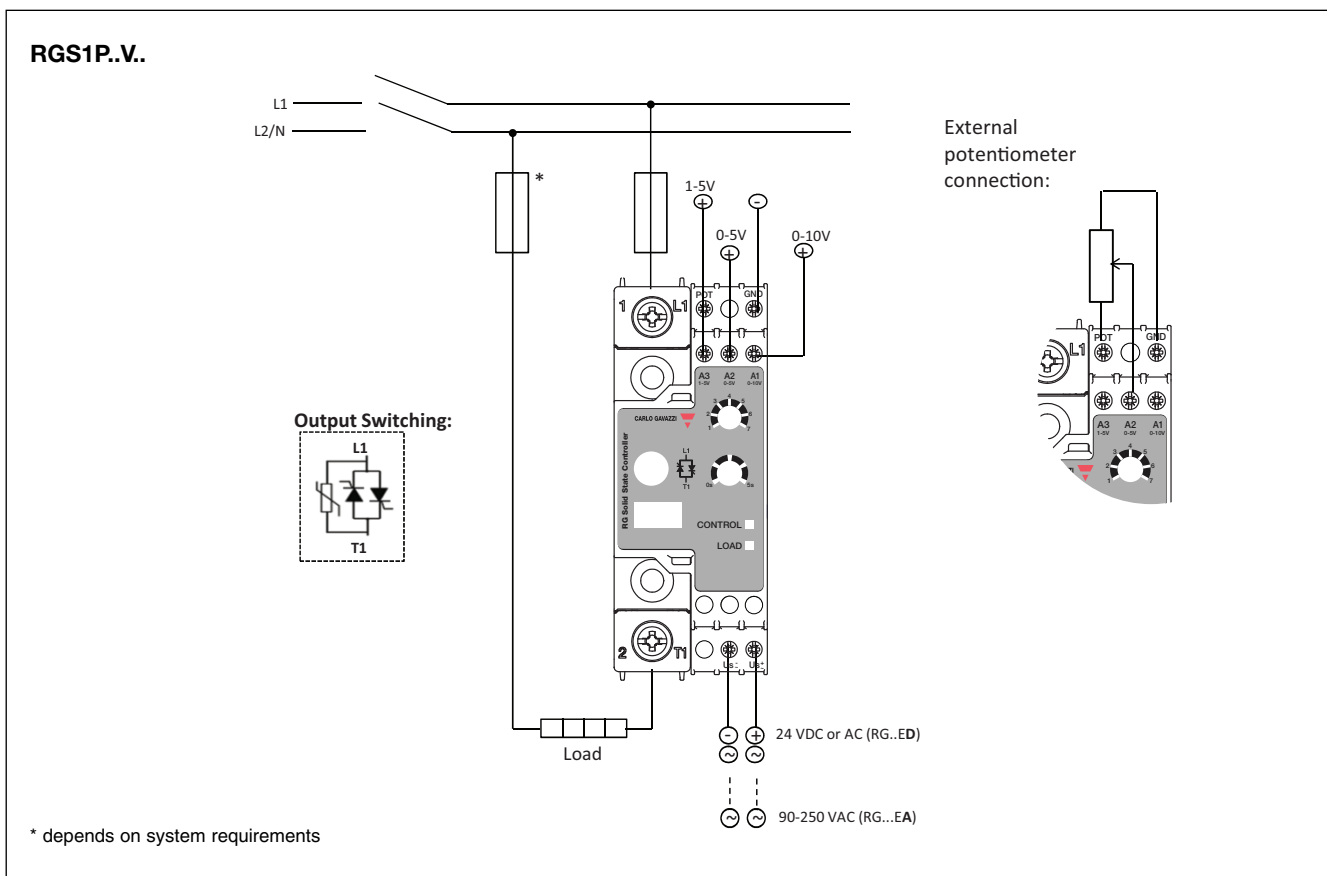
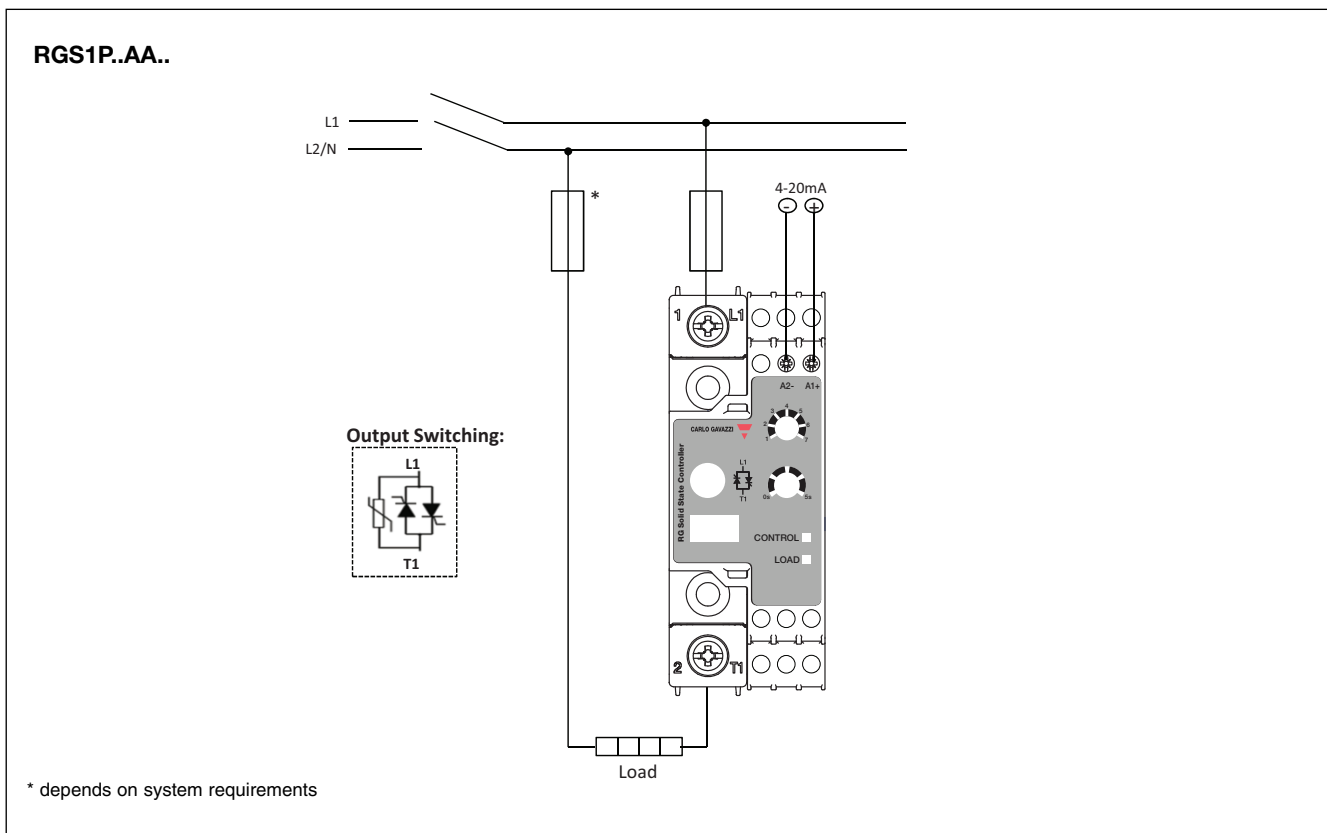

Short Circuit Protection

Protection Co-ordination, Type 1 vs Type 2:

Type 1 protection implies that after a short circuit, the device under test will no longer be in a functioning state. In type 2 co-ordination the device under test will still be functional after the short circuit. In both cases, however the short circuit has to be interrupted. The fuse between enclosure and supply shall not open. The door or cover of the enclosure shall not be blown open. There shall be no damage to conductors or terminals and the conductors shall not separate from terminals. There shall be no breakage or cracking of insulating bases to the extent that the integrity of the mounting of live parts is impaired. Discharge of parts or any risk of fire shall not occur.

The product variants listed in the table hereunder are suitable for use on a circuit capable of delivering not more than 100,000A Symmetrical Amperes, 600Volts maximum when protected by fuses. Tests at 100,000Arms were performed with Class J fuses, fast acting; please refer to the tables below for maximum ratings. Tests with Class J fuses are representative of Class CC fuses.

Co-ordination type 1 (UL508)

Part No.	Short circuit current [kArms]	Max. fuse size [A]	Class	Voltage [VAC]
RGS1P..50	100	30	J or CC	Max. 600
RGS1P..92	100	80	J	Max. 600

Co-ordination type 2 (EN/IEC 60947-4-3)

Part No.	Short circuit current [kArms]	Ferraz Shawmut (Mersen)		Siba		Voltage [VAC]
		Max. fuse size [A]	Part No.	Max. fuse size [A]	Part No.	
RGS1P..50	10	40	6.9xx CP GRC 22x58 /40	32	50 142 06.32	Max. 600
	100	40	6.9xx CP URD 22x58 /40	32	50 142 06.32	Max. 600
RGS1P..92	10	125	6.621 CP URQ 27x60 /125	125	50 194 20.125	Max. 600
	10	125	A70QS125-4	125	50 194 20.125	Max. 600
	100	125	6.621 CP URQ 27x60 /125	125	50 194 20.125	Max. 600
	100	125	A70QS125-4	125	50 194 20.125	Max. 600

xx = 00, without fuse trip indication

xx = 21, with fuse trip indication

Type 2 Protection with Miniature Circuit Breakers (M.C.B.s)

Solid State Relay type	ABB Model no. for Z - type M. C. B. (rated current)	ABB Model no. for B - type M. C. B. (rated current)	Wire cross sectional area [mm ²]	Minimum length of Cu wire conductor [m] ¹¹
RGS1P..50	1 pole S201 - Z10 (10A)	S201-B4 (4A)	1.0	7.6
			1.5	11.4
			2.5	19.0
	S201 - Z16 (16A)	S201-B6 (6A)	1.0	5.2
			1.5	7.8
			2.5	13.0
			4.0	20.8
	S201 - Z20 (20A)	S201-B10 (10A)	1.5	12.6
			2.5	21.0
	S201 - Z25 (25A)	S201-B13 (13A)	2.5	25.0
4.0			40.0	
2 pole S202 - Z25 (25A)		S202-B13 (13A)	2.5	19.0
			4.0	30.4
RGS1P..92	1 pole S201-Z32 (32A)	S201-B16 (16A)	2.5	3.0
			4.0	4.8
			6.0	7.2
	S201-Z50 (50A)	S201-B25 (25A)	4.0	4.8
			6.0	7.2
			10.0	12.0
			16.0	19.2
	S201-Z63 (63A)	S201-B32 (32A)	6.0	7.2
			10.0	12.0
			16.0	19.2

11. Between MCB and Load (including return path which goes back to the mains).

Note: A prospective current of 6kA and a 230/400V power supply system is assumed for the above suggested specifications. For cables with different cross section than those mentioned above please consult Carlo Gavazzi's Technical Support Group.

Accessories

Tamper Proof Accessory Kit



Ordering Key

RGTMP

Tamper proof accessory kit for RGS1P, RGC1P series containing:

- x5 transparent covers
- x5 secureness ties

Installation

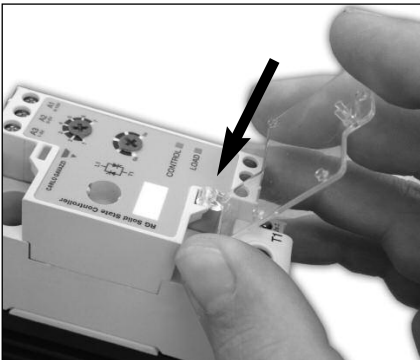

1: Clip hook of the transparent cover to the bottom loop of the RGx1P control module

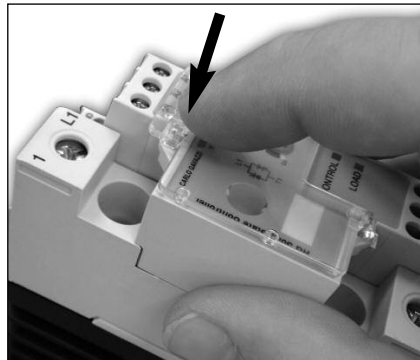

2: Close the cover by clipping to the top loop of the RGx1P control module

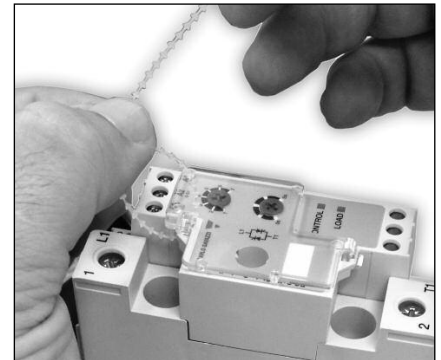

3: Secure with provided tie

Heatsink Selection

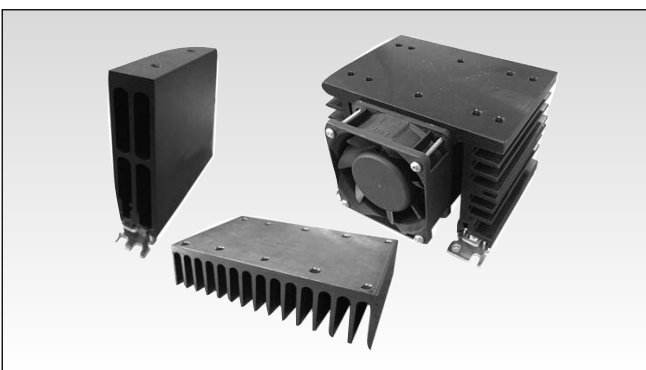

Ordering Key

RHS..

- Heatsinks and fans
- 5.40°C/W to 0.12°C/W thermal resistance
- DIN, panel or thru wall mounting
- Single or multiple SSR mounting

Heatsink Range Overview:

http://www.productselection.net/PDF/UK/ssr_accessories.pdf

Heatsink Selector Tool:

<http://www.productselection.net/heatsink/heatsinkselector.php?LANG=UK>

Thermal Pads

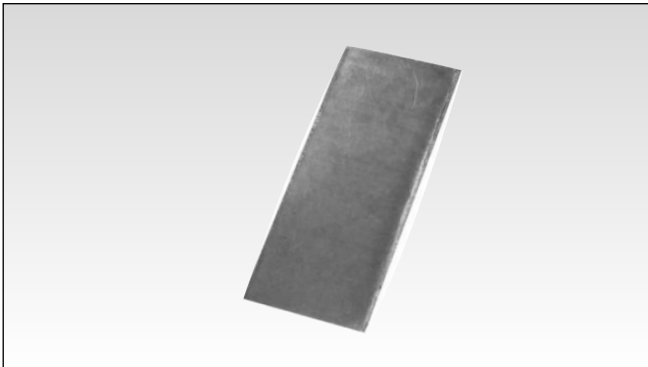

Ordering Key

RGHT

- Graphite thermal pad for RG series with adhesive on one side
- Width x Height x Thickness = 14 x 35 x 0.13 mm
- Packing qty. 10 pcs.

Thermal Paste

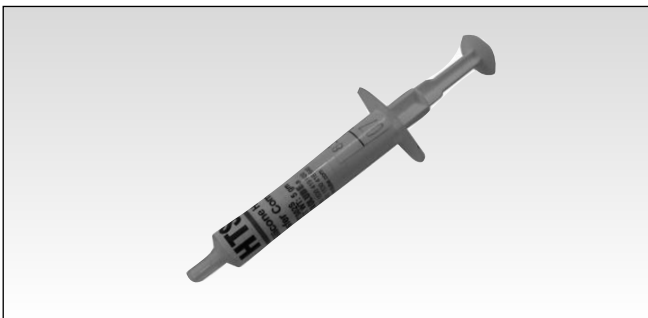

Ordering Key

HTS02S

- Silicone based thermal paste syringe
- Volume = 2ml
- Packing qty. 1 pc.

Screw Kits



Ordering Key **SRWKIT M5 X 30MM**

- RGS Screw kit for mounting to heatsink
- Torx T20, size M5 x 30mm
- Packing qty: 20pcs.