

## ZCM Series Datasheet

SMD Precision Metal Film Resistors | MELF Style

### ORDERING CODE-Example

New SAP Part Nr.:

ZCM	207	F	K	E	07-	1K	AA
Serie	Power rating 204 = 0,4W 207 = 1,0W	Tol. B = ±0,1% C = ±0,25% D = ±0,5% F = ±1% G = ±2% J = ±5%	Pack-Code K = Blister tape reel	TCR C = ±15ppm D = ±25ppm E = ±50ppm F = ±100ppm	Forming type 07- = 07 inch (Reel diameter) or 13- = 13 inch (Reel diameter)	R Value	Special AA = Standard

Historical VTM Part Nr.:

ZC	0207	F	K	E	07	1K
Type	Size	Tol.	K = Blister tape reel	TC	Reel diam.	R Value

### APPLICATIONS

- Automotive
- Charger
- Alternative Energy
- Power Supply
- Home Appliances
- Industrial

### FEATURES

- Precision MELF resistor
- Advanced MELF technology
- Excellent stability in different environmental conditions
- Best in class pulse load capability
- AEC – Q200 Qualified
- Intrinsic sulfur resistance
- RoHS & REACH Compliant

### ELECTRICAL SPECIFICATIONS

Type		ZCM204	ZCM207
Historical Part Number	SMD	ZC0204	ZC0207
Nominal Power Rating $P_{70}$	[W]	0,4	1,0
Resistance Range	[Ω]	OR22 ... 10M	OR16 ... 10M
		(Other values upon request)	
E-Series		E24 / E96 / E192	
Tolerances	±[%]	B = 0,1% , C = 0,25% , D = 0,5% , F = 1% , G = 2% , J = 5%	
Temperature Coefficient <i>IEC60115-1 clause 4.2 ; 4.8</i> <i>(+20 / -55[°C] and (+20 / +125[°C])</i>	±[10 <sup>-6</sup> *K <sup>-1</sup> ]	Depends on the value, please check the table below	
Working Temperature Range	[°C]	-55 ... +155	
Permissible film temperature <i>(9F max.)</i>	[°C]	155	
Max. Working Voltage	[AC or DC] <sub>RMS</sub>	200	350
Dielectric Withstanding Voltage <i>IEC115-1 clause 4.7 (1[min])</i>	[V] <sub>RMS</sub>	300	500

### DIMENSIONS [mm]

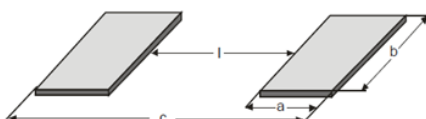
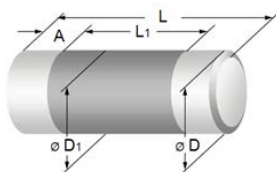

Type	Historical P/N:	L	∅ D	L <sub>1</sub>	∅ D <sub>1</sub>	A	MASS (mg)
ZCM204	ZC0204	3,6 +0/-0,2	1,4 +0/-0,1	1,8 min.	D +0/-0,15	0,80 ±0,10	22
ZCM207	ZC0207	5,8 +0/-0,3	2,2 ±0,2	2,6 min.	D +0/-0,2	1,25 ±0,2	77

#### Recommended solder pads dimensions

Type	Wave soldering				Reflow soldering			
	l	a	b	c	l	a	b	c
ZCM204	1,5	1,5	1,8	4,5	1,7	1,2	1,6	4,1
ZCM207	2,4	2,3	2,6	7,0	2,6	2,0	2,4	6,6

# ZCM Series Datasheet

## PERFORMANCE DATE

Type			ZCM204	ZCM207	
Historical Part Number			ZC0204	ZC0207	
Climatic Category			55/155/56		
Short Time Overload IEC60115-1 clause 4.13 ( $U=2,5 \cdot \sqrt{P_{10} \times R} \cdot \leq 2 \cdot U_{max, 5 [s]}$ )	Standard operation	±[%]	0,03 (≤1M) ; 0,1 (>1M)	0,03 (≤1M) ; 0,15 (>1M)	
	Power operation		0,05 (≤1M) ; 0,1 (>1M)	0,05 (≤1M) ; 0,15 (>1M)	
Single pulse high voltage overload IEC60115-1 clause 4.27 ( $U=10 \cdot \sqrt{P_{10} \times R}$ , Severity 4, 10 pulses 10[μs]/700[μs])	Standard operation	±[%]	0,15	0,25	
	Power operation		0,15	0,5	
Periodic electric overload IEC60115-1 clause 4.39 ( $U=15 \cdot \sqrt{P_{10} \times R}$ , 0.1[s]on, 2.5[s]off, 1000 cycles)	Standard operation	±[%]	0,15	0,15	
	Power operation		0,3	0,3	
Failure Rate (Total, 90, max, 60[%] cont. lev.)		[10 <sup>-9</sup> h <sup>-1</sup> ]	≤ 0,1		
Endurance at 70°C, IEC60115-1 clause 4.25.1 ( $U=\sqrt{P_{10} \times R} \cdot U_{max}$ , 1,5[h]ON ; 0,5[h]OFF)	Precision operation	±[%]	1000h	0.05 (10R≤1M)	
			8000h	0.1 (10R≤1M)	
	Standard operation	±[%]	1000h	0.15 (<10R) ; 0.1 (10R≤1M) ; 0.25 (>1M)	0.15 (≤1M) ; 0.5 (>1M)
			8000h	0.3 (<10R) ; 0.2 (10R≤1M) ; 0.5 (>1M)	0.3 (≤1M) ; 1 (>1M)
Power operation	±[%]	1000h	0.25	0.25 (≤1M) ; 0.5 (>1M)	
		8000h	0.5	0.5 (≤1M) ; 1 (>1M)	
Endurance at upper Category Temp. IEC60115-1 clause 4.25.3 ( 1000[h])	±[%]	125°C	0.15 (<10R) ; 0.1 (10R≤1M) ; 0.25 (>1M)	0.15 (≤1M) ; 0.5 (>1M)	
		155°C	0.3 (<10R) ; 0.2 (10R≤1M) ; 0.5 (>1M)	0.3 (≤1M) ; 1 (>1M)	
Damp Heat, Steady State IEC60115-1 clause 4.24 (40 <sup>±2</sup> [°C], 93 <sup>±3</sup> [% r.h.], 56[d])		±[%]	0,15 (≤ 1M) ; 0,25 (>1M)	0,25 (≤ 1M) ; 1 (>1M)	
Damp Heat, Steady State, Accelerated IEC60115-1 clause 4.37 (85 <sup>±2</sup> [°C], 85 <sup>±5</sup> [%RH], $U=0.3 \cdot \sqrt{P_{10} \times R}$ )		±[%]	0,25 (≤ 1M) ; 2 (>1M)	0,5 (≤ 1M) ; 2 (>1M)	
Temperature Cycling IEC60068-2-14 ; IEC60115-1 clause 4.19 ( 30[min] each , 1000 cycles)	±[%]	-55~125°C	0,15 (≤ 1M) ; 0,25 (>1M)	0,25	
		-55~155°C	0,5	0,5	
Vibration IEC60068-2-6 ; IEC60115-1 clause 4.22 (10;2000[Hz], ≤1,5[mm] , or ≤200[m/s <sup>2</sup> ] 7,5[h])		±[%]	0,05 (≤ 1M) ; 0,1 (>1M)	0,05	
Resistance to Soldering Heat IEC60115-1 clause 4.18 (260 <sup>±3</sup> [°C], 10 <sup>±1</sup> [s])Solder bath method		±[%]	0,1 (≤ 10R) ; 0,05 (>10R)	0,1 (≤ 10R) ; 0,05 (>10R)	
Electrostatic Discharge IEC60115-1 clause 4.38 ; IEC61340-3-1 ( 3 positives + 3 negatives discharges)		±[%]	0,5 [2 kV]	0,5 [4 kV]	
Voltage proof IEC60115-1 clause 4.7 $U_{RMS}=U_{INS}$ , 60 [s]			No flash over or breakdown		
Flammability IEC60115-1 clause 4.35, IEC60695-11-5 Needle flame test, 10[s]			No burning after 30[s]		
Solderability IEC60068-2-20 ; IEC60115-1 clause 4.17 (235 <sup>±3</sup> [°C] 2 <sup>±0,2</sup> [s], SnAg <sub>3</sub> Cu <sub>0,5</sub> or SnAg <sub>3,5</sub> )			≥ 95% covered, no visible damage		
Component Resistance to Solvents IEC60068-2-45 ; IEC60115-1 clause 4.29 (50[°C] method 2)			No visible damage		
Resistance to solvents of Marking IEC60068-2-45 ; IEC60115-1 clause 4.30 (50[°C] method 1)			Marking visible , no visible damage		
Marking IEC60062			Color code		

### NOTES: MARKING [COLOR CODE]:

- **ZCM204** Color code marking is applied according to IEC 60062 in four bands (E24 series) for 5 % tolerance, or in five bands (E96 or E192 series). Each color band appears as a single solid line, voids are permissible if at least 2/3 of the band is visible from each radial angle of view. The last color band for tolerance is approximately 50 % wider than the other bands.
  - **ZCM207** Color code marking is applied according to IEC 60062 in four (E24 series) or six bands (E96 series). Each color band appears as a single solid line, voids are permissible if at least 2/3 of the band is visible from each radial angle of view. The last color band represents the TCR for resistors with TCR ≤50 ppm/K and nominal tolerance ≤1 %.
- Zero ohm jumpers** are marked with one centered black band.

## ZCM Series Datasheet

### TEMPERATURE COEFFICIENT

ZCM204		ZCM207		Tolerance	TCR	E-Series
Resistance range						
0R22 ... 0R91	0R16 ... 0R91			± 5%	± 100 ppm/K	E24
	0R22 ... 0R91			± 2%		
0R82... 10M	1R... 10M			± 1%	± 50 ppm/K	E24 / E96
10R... 1M65	1R... 2M21			± 0,5%		
10R... 1M65	43R... 1M			± 0,5%	± 25 ppm/K	E24 / E192
22R... 1M65	43R... 1M			± 0,25%		
22R... 1M65	43R... 1M			± 0,1%	± 15 ppm/K	E24 / E192
10R... 221K	100R... 511K			± 0,5%		
22R... 221K	100R... 511K			± 0,25%		
43R... 221K	100R... 511K			± 0,1%		
Jumper $I_{max} = 3A$	Jumper $I_{max} = 5A$			≤ 10 mΩ		

- The body coating color is light green for jumpers and for a temperature coefficient of ±50 or 100 [ppm], pink for ±25[ppm] and violet for ±15[ppm]

### MAXIMUM RESISTANCE CHANGE AT RATED DISSIPATION

OPERATION MODE	ZCM204			ZCM207			
	PRECISION	STANDARD	POWER	PRECISION	STANDARD	POWER	
Rated Power dissipation $P_{70}$ [W]	0,07	0,25	0,4	0,125	0,4	1,0	
Operating temp. range [°C]	-10 to 85	-55 to 125	-55 to 155	-10 to 85	-55 to 125	-55 to 155	
Permissible film temperature $\vartheta F_{Max}$ [°C]	85	125	155	85	125	155	
Resistance range	10R – 1M	R22 – 1M	R22 – 10M	100R – 511K	1R0 – 1M	1R0 – 1M	
Max. Resistance drift [%] [ $\Delta R/R$ ]	1000h	≤0,05	≤0,15	≤0,25	≤0,05	≤0,15	≤0,25
	8000h	≤0,1	≤0,3	≤0,5	≤0,1	≤0,3	≤0,5
	225 000h	≤0,25	≤0,75	-	≤0,25	≤1,0	-

- A suitable low thermal resistance of the circuit board assembly must be safeguarded in order to maintain the film temperature of the resistors within the specified limits.

### PERFORMANCE GRAPH'S

Derating – Precision Operation

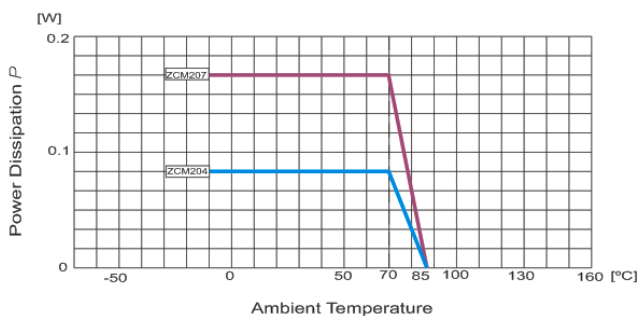

Derating – Standard Operation

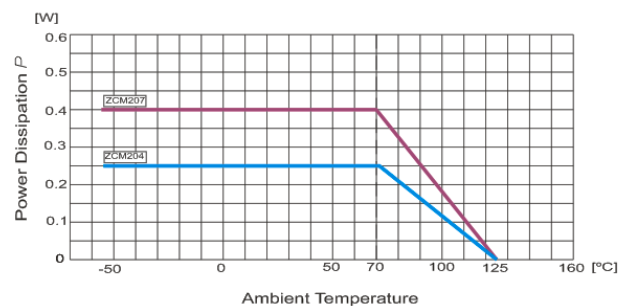

Derating – Power Operation

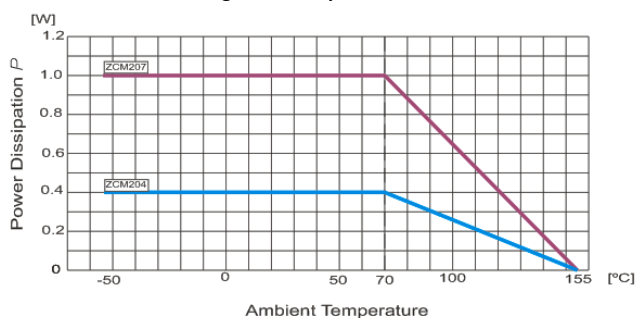

Non- Linearity

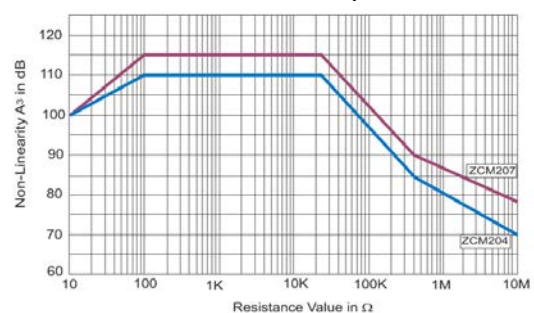

## ZCM Series Datasheet

**Current Noise**

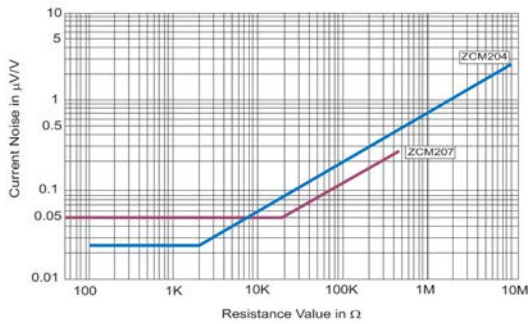

**Pulse Voltage**

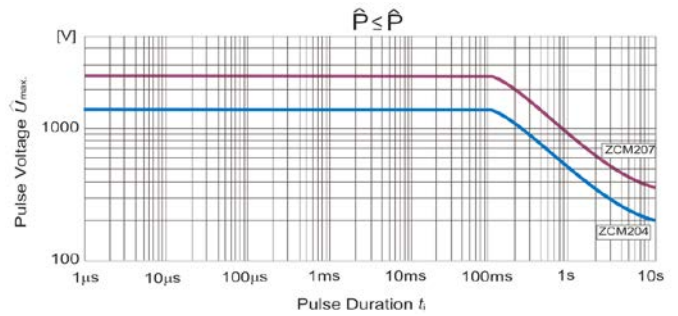

**Single Pulse for  $R < 10\Omega$**

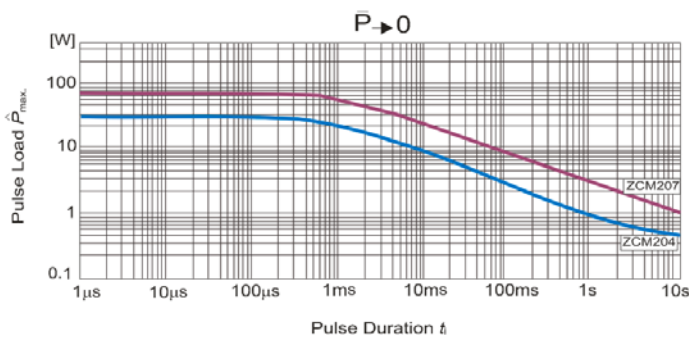

**Continuous Pulse for  $R < 10\Omega$**

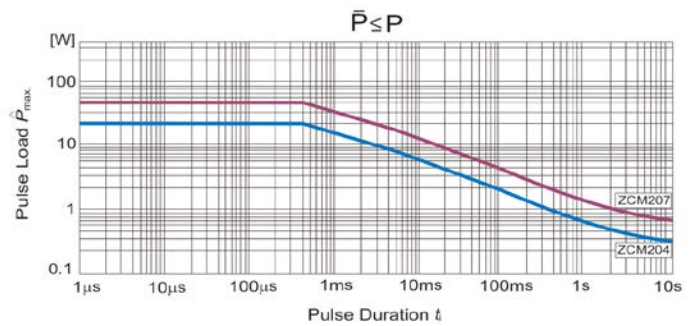

**Single Pulse for  $R \geq 10\Omega$**

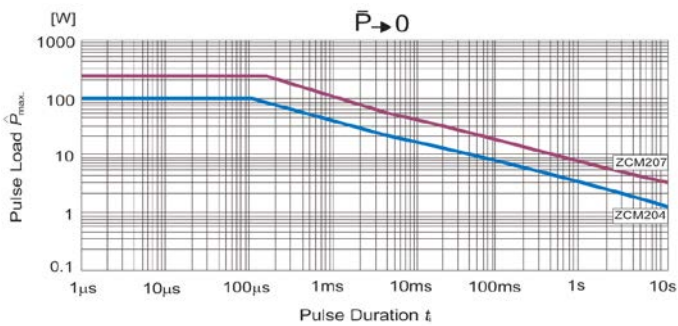

**Continuous Pulse for  $R \geq 10\Omega$**

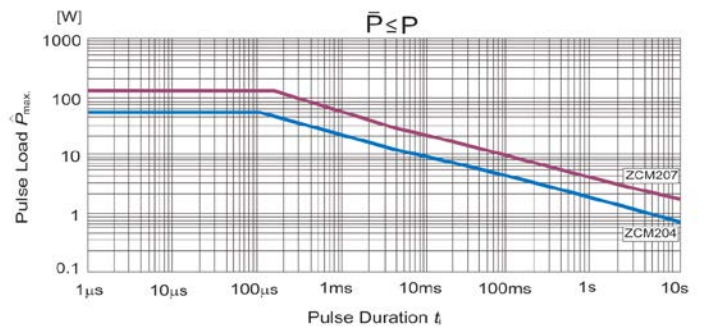

**Single Pulse (1.2/50 [ $\mu\text{s}$ ])**

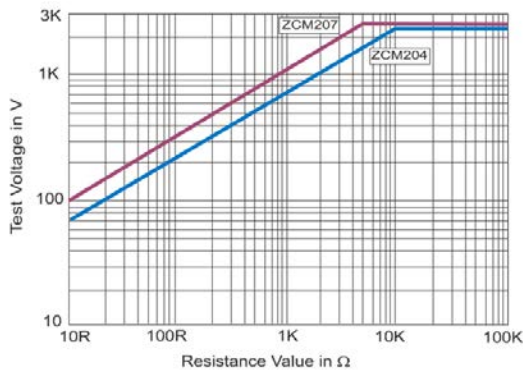

**Single Pulse (10/700 [ $\mu\text{s}$ ])**

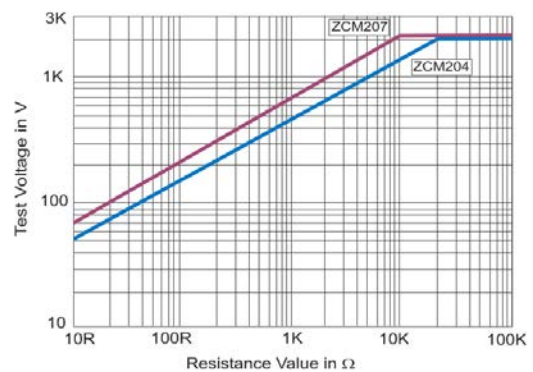

## ZCM Series Datasheet

### PACKAGING - Blister tape

The type ZCM is packed in antistatic blister tape according to IEC60286-3, type 2a, packing details described below,

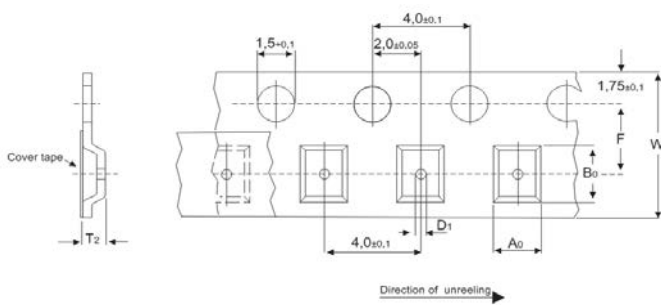
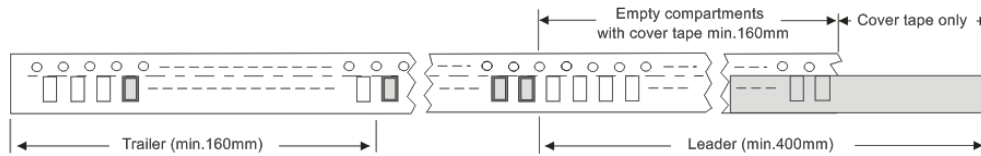

Type	A0	B0	F	W	D1	T2
ZCM204	1,55±0,1	3,7±0,1	3,5±0,05	8,0.±0,3	1,0	≤ 1,8
ZCM207	2,40±0,1	6,0±0,1	5,5±0,05	12,0.±0,3	1,5	≤ 2,7

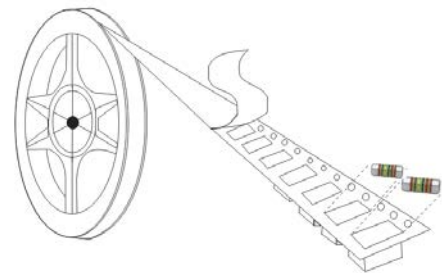
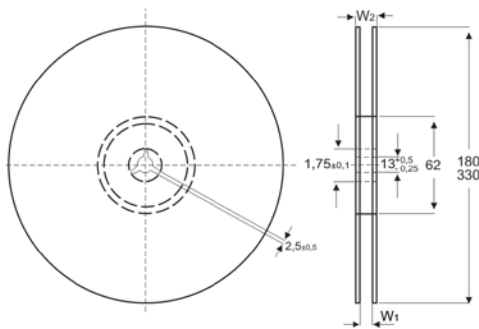

Type	W1 [±1,5]	W2 [max]
ZCM204	8,4	14,4
ZCM207	12,4	18,4

Type	Packaging [dimensions]	Quantity [pcs]
ZCM204	07(inch)	3000
ZCM207	Blister tape	1500
ZCM204	13(inch)	10000
ZCM207	Blister tape	7500