

Printed-circuit board connector - MCVW 1,5/ 2-ST-3,81 - 1826979

Please be informed that the data shown in this PDF Document is generated from our Online Catalog. Please find the complete data in the user's documentation. Our General Terms of Use for Downloads are valid (<http://phoenixcontact.com/download>)



Plug component, Nominal current: 8 A, Rated voltage (III/2): 160 V, Number of positions: 2, Pitch: 3.81 mm, Connection method: Screw connection with tension sleeve, Color: green, Contact surface: Tin

The figure shows a 10-position version of the product

Why buy this product

- Well-known connection principle allows worldwide use
- Low temperature rise, thanks to maximum contact force
- Allows connection of two conductors



Key Commercial Data

Packing unit	250 STK
Minimum order quantity	250 STK
GTIN	 4 017918 050047
GTIN	4017918050047
Weight per Piece (excluding packing)	0.002 kg
Custom tariff number	85366990
Country of origin	Germany

Technical data

Environmental Product Compliance

China RoHS	Hazardous substances above threshold values;
	Environmentally Friendly Use Period = 50;
	For details go to tab "Downloads", Category "Manufacturer's declaration"

Dimensions

Height	12.5 mm
Width	8.11 mm
Pitch	3.81 mm

Printed-circuit board connector - MCVW 1,5/ 2-ST-3,81 - 1826979

Technical data

Dimensions

Dimension a	3.81 mm
-------------	---------

General

Range of articles	MCVW 1,5/..-ST
Type of contact	Female connector
Number of positions	2
Connection method	Screw connection with tension sleeve
Insulating material group	I
Rated surge voltage (III/3)	2.5 kV
Rated surge voltage (III/2)	2.5 kV
Rated surge voltage (II/2)	2.5 kV
Rated voltage (III/3)	160 V
Rated voltage (III/2)	160 V
Rated voltage (II/2)	320 V
Connection in acc. with standard	EN-VDE
Nominal current I_N	8 A
Nominal cross section	1.5 mm ²
Maximum load current	8 A (with 1.5 mm ² conductor cross section)
Insulating material	PA
Flammability rating according to UL 94	V0
Internal cylindrical gage	A1
Stripping length	7 mm
Screw thread	M2
Tightening torque, min	0.22 Nm
Tightening torque max	0.25 Nm

Connection data

Conductor cross section solid min.	0.14 mm ²
Conductor cross section solid max.	1.5 mm ²
Conductor cross section flexible min.	0.14 mm ²
Conductor cross section flexible max.	1.5 mm ²
Conductor cross section flexible, with ferrule without plastic sleeve min.	0.25 mm ²
Conductor cross section flexible, with ferrule without plastic sleeve max.	1.5 mm ²
Conductor cross section flexible, with ferrule with plastic sleeve min.	0.25 mm ²
Conductor cross section flexible, with ferrule with plastic sleeve max.	0.5 mm ²
Conductor cross section AWG min.	28
Conductor cross section AWG max.	16
2 conductors with same cross section, solid min.	0.08 mm ²
2 conductors with same cross section, solid max.	0.5 mm ²
2 conductors with same cross section, stranded min.	0.08 mm ²
2 conductors with same cross section, stranded max.	0.75 mm ²

Printed-circuit board connector - MCVW 1,5/ 2-ST-3,81 - 1826979

Technical data

Connection data

2 conductors with same cross section, stranded, ferrules without plastic sleeve, min.	0.25 mm ²
2 conductors with same cross section, stranded, ferrules without plastic sleeve, max.	0.34 mm ²
2 conductors with same cross section, stranded, TWIN ferrules with plastic sleeve, min.	0.5 mm ²
2 conductors with same cross section, stranded, TWIN ferrules with plastic sleeve, max.	0.5 mm ²
Minimum AWG according to UL/CUL	30
Maximum AWG according to UL/CUL	14

Standards and Regulations

Connection in acc. with standard	EN-VDE
	CSA
Flammability rating according to UL 94	V0

Drawings

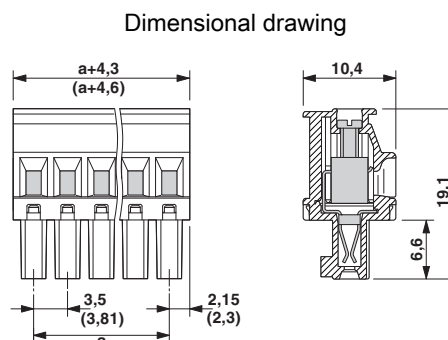
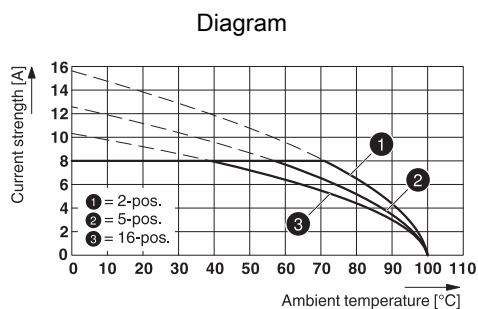

Type: MCVW 1,5/...-ST-3,81 with MC 1,5/...-G-3,81

Classifications

eCl@ss

eCl@ss 4.0	272607xx
eCl@ss 4.1	27260701
eCl@ss 5.0	27260701
eCl@ss 5.1	27260701
eCl@ss 6.0	27260704
eCl@ss 7.0	27440402
eCl@ss 8.0	27440309
eCl@ss 9.0	27440309

ETIM

ETIM 3.0	EC001121
ETIM 4.0	EC002638

Printed-circuit board connector - MCVW 1,5/ 2-ST-3,81 - 1826979

Classifications

ETIM

ETIM 5.0	EC002638
----------	----------

UNSPSC

UNSPSC 6.01	30211810
UNSPSC 7.0901	39121409
UNSPSC 11	39121409
UNSPSC 12.01	39121409
UNSPSC 13.2	39121409

Approvals

Approvals

Approvals

CSA / VDE Gutachten mit Fertigungsüberwachung / IECCEB Scheme / CCA / EAC / cULus Recognized / EAC

Ex Approvals

Approval details

CSA  http://www.csagroup.org/us/en/services/testing-and-certification/certified-product-listing 13631		
	B	D
mm ² /AWG/kcmil	28-16	28-16
Nominal current I _N	8 A	8 A
Nominal voltage U _N	300 V	300 V

VDE Gutachten mit Fertigungsüberwachung  http://www.vde.de 40011723	
mm ² /AWG/kcmil	0.2-1.5
Nominal current I _N	8 A
Nominal voltage U _N	160 V

Printed-circuit board connector - MCVW 1,5/ 2-ST-3,81 - 1826979

Approvals

IECEE CB Scheme  http://www.iecee.org/ DE1-56063-B1B2	
mm ² /AWG/kcmil	0.2-1.5
Nominal current I _N	8 A
Nominal voltage U _N	160 V

CCA CCA/ DE1 34219	
mm ² /AWG/kcmil	0.2-1.5
Nominal current I _N	8 A
Nominal voltage U _N	160 V

EAC EAC-Zulassung

cULus Recognized http://database.ul.com/cgi-bin/XYV/template/LISEXT/1FRAME/index.htm E60425-20110128		
	B	D
mm ² /AWG/kcmil	30-14	30-14
Nominal current I _N	8 A	8 A
Nominal voltage U _N	300 V	300 V

EAC B.01742

Accessories

Accessories

Bridge

Insertion bridge - EBPL 2-3,81 - 1733495



Insertion bridge for plugs featuring a screw connection with a 3.81 mm pitch

Labeled terminal marker

Printed-circuit board connector - MCVW 1,5/ 2-ST-3,81 - 1826979

Accessories

Marker card - SK 3,81/2,8:FORTL.ZAHLEN - 0804109



Marker card, Card, white, labeled, Horizontal: Consecutive numbers 1 - 10, 11 - 20, etc. up to 91 - (99)100, Mounting type: Adhesive, for terminal block width: 3.81 mm, Lettering field: 3.81 x 2.8 mm

Marker pen

Marker pen - B-STIFT - 1051993



Marker pen, for manual labeling of unprinted Zack strips, smear-proof and waterproof, line thickness 0.5 mm

Screwdriver tools

Screwdriver - SZS 0,4X2,5 VDE - 1205037



Screwdriver, slot-headed, VDE insulated, size: 0.4 x 2.5 x 80 mm, 2-component grip, with non-slip grip

Terminal marking

Marker card - SK U/2,8 WH:UNBEDRUCKT - 0803883



Marker card, Sheet, white, unlabeled, can be labeled with: Plotter, Office printing systems, Mounting type: Adhesive, Lettering field: 186 x 2.8 mm

Additional products

Base strip - MCV 1,5/ 2-G-3,81 P14 THR - 1707007



Header, Nominal current: 8 A, Rated voltage (III/2): 160 V, Number of positions: 2, Pitch: 3.81 mm, Color: black, Contact surface: Tin, Mounting: THR soldering, User information and design recommendations for through hole reflow technology can be found under "Downloads"

Printed-circuit board connector - MCVW 1,5/ 2-ST-3,81 - 1826979

Accessories

Base strip - MCV 1,5/ 2-G-3,81 P26 THR - 1707421



Header, Nominal current: 8 A, Rated voltage (III/2): 160 V, Number of positions: 2, Pitch: 3.81 mm, Color: black, Contact surface: Tin, Mounting: THR soldering, User information and design recommendations for through hole reflow technology can be found under "Downloads"

Header - MCV 1,5/ 2-G-3,81 P26 THRR32 - 1713554



Header, Nominal current: 8 A, Rated voltage (III/2): 160 V, Number of positions: 2, Pitch: 3.81 mm, Color: black, Contact surface: Tin, Mounting: THR soldering, User information and design recommendations for through hole reflow technology can be found under "Downloads"

Printed-circuit board connector - MC 1,5/ 2-G-3,81 P20 THRR32 - 1782572



Header, Nominal current: 8 A, Rated voltage (III/2): 160 V, Number of positions: 2, Pitch: 3.81 mm, Color: black, Contact surface: Tin, Mounting: THR soldering

Base strip - MC 1,5/ 2-G-3,81 - 1803277



Header, Nominal current: 8 A, Rated voltage (III/2): 160 V, Number of positions: 2, Pitch: 3.81 mm, Color: green, Contact surface: Tin, Mounting: Wave soldering

Base strip - MCV 1,5/ 2-G-3,81 - 1803426



Header, Nominal current: 8 A, Rated voltage (III/2): 160 V, Number of positions: 2, Pitch: 3.81 mm, Color: green, Contact surface: Tin, Mounting: Wave soldering

Printed-circuit board connector - MCVW 1,5/ 2-ST-3,81 - 1826979

Accessories

Base strip - SMC 1,5/ 2-G-3,81 - 1827279



Header, Nominal current: 8 A, Rated voltage (III/2): 160 V, Number of positions: 2, Pitch: 3.81 mm, Color: green, Contact surface: Tin, Mounting: Wave soldering

Base strip - MCD 1,5/ 2-G-3,81 - 1829950



Header, Nominal current: 8 A, Rated voltage (III/2): 160 V, Number of positions: 2, Pitch: 3.81 mm, Color: green, Contact surface: Tin, Mounting: Wave soldering, In combination with MCV plug components, both an MCVW and an MCVR plug must be used.

Base strip - MCDV 1,5/ 2-G-3,81 - 1830402



Header, Nominal current: 8 A, Rated voltage (III/2): 160 V, Number of positions: 2, Pitch: 3.81 mm, Color: green, Contact surface: Tin, Mounting: Wave soldering, In combination with MCV plug components, both an MCVW and an MCVR plug must be used.

Base strip - MCVDU 1,5/ 2-G-3,81 - 1837450

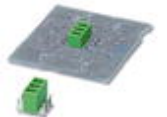

Header, Nominal current: 8 A, Rated voltage (III/2): 160 V, Number of positions: 2, Pitch: 3.81 mm, Color: green, Contact surface: Tin, Mounting: Wave soldering

Base strip - MCD 1,5/ 2-G1-3,81 - 1843075



Header, Nominal current: 8 A, Rated voltage (III/2): 160 V, Number of positions: 2, Pitch: 3.81 mm, Color: green, Contact surface: Tin, Mounting: Wave soldering, In combination with MCV plug components, both an MCVW and an MCVR plug must be used.

Printed-circuit board connector - MCVW 1,5/ 2-ST-3,81 - 1826979

Accessories

Base strip - MCDV 1,5/ 2-G1-3,81 - 1847725



Header, Nominal current: 8 A, Rated voltage (III/2): 160 V, Number of positions: 2, Pitch: 3.81 mm, Color: green, Contact surface: Tin, Mounting: Wave soldering, In combination with MCV plug components, both an MCVW and an MCVR plug must be used.

Base strip - EMCV 1,5/ 2-G-3,81 - 1860647



Header, Nominal current: 8 A, Rated voltage (III/2): 160 V, Number of positions: 2, Pitch: 3.81 mm, Color: green, Contact surface: Tin, Mounting: Press-in technology

Base strip - EMC 1,5/ 2-G-3,81 - 1897801



Header, Nominal current: 8 A, Rated voltage (III/2): 160 V, Number of positions: 2, Pitch: 3.81 mm, Color: green, Contact surface: Tin, Mounting: Press-in technology

Base strip - MC 1,5/ 2-G-3,81 THT - 1908761



Header, Nominal current: 8 A, Rated voltage (III/2): 160 V, Number of positions: 2, Pitch: 3.81 mm, Color: black, Contact surface: Tin, Mounting: THR soldering, User information and design recommendations for through hole reflow technology can be found under "Downloads"

Base strip - MC 1,5/ 2-G-3,81 THT-R56 - 1943755



Header, Nominal current: 8 A, Rated voltage (III/2): 160 V, Number of positions: 2, Pitch: 3.81 mm, Color: black, Contact surface: Tin, Mounting: THR soldering, User information and design recommendations for through hole reflow technology can be found under "Downloads"