



Single Display, PID Control

Specifications

Series	TC4S	TC4SP	TC4Y	TC4M	TC4W	TC4H	TC4L
Control output	250VAC~ 3A, 30VDC= 3A, 1a						
Relay	12VDC ±2V 20mA Max.						
Alarm output	AL1, AL2 Relay: 250VAC 1A 1a (※TC4SP, TC4Y have AL1 only.)						
Control method	ON/OFF and P, PI, PD, PID control						
Hysteresis	1 to 100°C/°F (0.1 to 50.0°C/°F) variable						
Proportional band (P)	0.1 to 999.9°C/°F						
Integral time (I)	0 to 9999 sec						
Derivative time (D)	0 to 9999 sec						
Control period (T)	0.5 to 120.0 sec						
Manual reset	0.0 to 100.0%						
Sampling period	100ms						
Dielectric strength	AC power	2,000VAC 50/60Hz for 1 min (between input terminal and power terminal)					
	AC/DC power	1,000VAC 50/60Hz for 1 min (between input terminal and power terminal)					
Vibration	0.75mm amplitude at frequency of 5 to 55Hz (for 1 min) in each X, Y, Z direction for 2 hours						
Relay life cycle	Mechanical	OUT: over 5,000,000 operations, AL1/2: Over 5,000,000 operations					
	Electrical	OUT: over 200,000 operations (250VAC 3A resistive load) AL1/2: over 300,000 operations (250VAC 1A resistive load)					
Insulation resistance	Over 100MΩ (at 500VDC megger)						
Noise immunity	Square-wave noise by noise simulator (pulse width 1us) ±2kV R-phase and S-phase						
Memory retention	Approx. 10 years (when using non-volatile semiconductor memory type)						
Environment	Ambient temperature	-10 to 50°C, storage: -20 to 60°C					
	Ambient humidity	35 to 85%RH, storage: 35 to 85%RH					
Insulation type	Double insulation or reinforced insulation (mark: ) Dielectric strength between the measuring input part and the power part: AC power 2kV, AC/DC Power 1kV)						
Approval	 						
Weight ^{※2}	Approx. 141g (approx. 94g)	Approx. 123g (approx. 76g)	Approx. 174g (approx. 85g)	Approx. 204g (approx. 133g)	Approx. 194g (approx. 122g)	Approx. 194g (approx. 122g)	Approx. 254g (approx. 155g)

※2: The weight includes packaging. The weight in parenthesis is for unit only.

※Environment resistance is rated at no freezing or condensation.

Connections

※TC4 Series has selectable control output; Relay output, and SSR drive output. AC/DC power type does not have SSRP function.

※Use crimp terminals or terminals of size specified below.

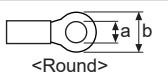
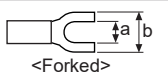
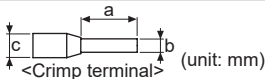
		
<Round>	<Forked>	<Crimp terminal> (unit: mm)
a: Min. 3.0mm	Min. 3.0mm	Terminal number
b: Max. 5.8mm	Max. 5.8mm	a
		b
		c
		1 to N
		6
		Max. 1.9
		Max. 4.0

TC4S

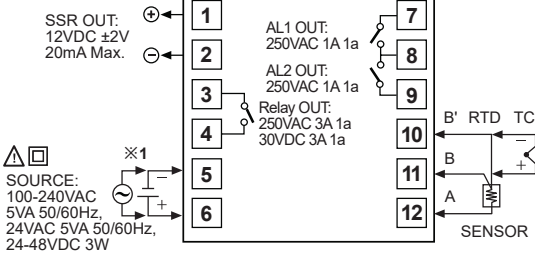

TC4SP

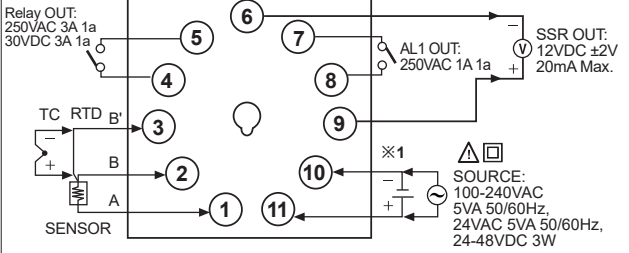

TC4Y

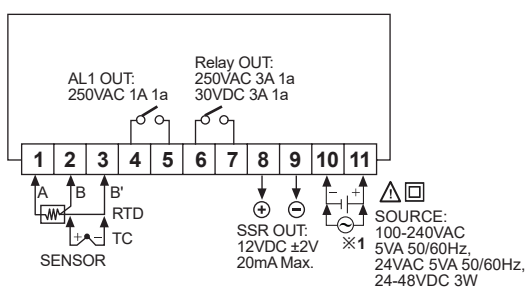

TC4W

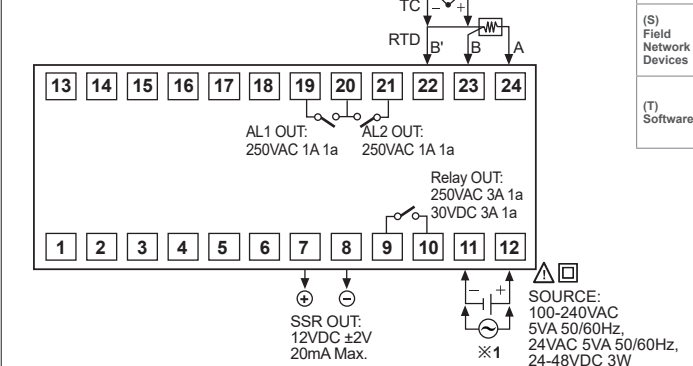

※1: AC power: 100-240VAC 5VA 50/60Hz
AC/DC power: 24VAC 5VA 50/60Hz, 24-48VDC 3W

(A) Photoelectric Sensors

(B) Fiber Optic Sensors

(C) Door/Area Sensors

(D) Proximity Sensors

(E) Pressure Sensors

(F) Rotary Encoders

(G) Connectors/ Connector Cables/ Sensor Distribution Boxes/Sockets

(H) Temperature Controllers

(I) SSRs / Power Controllers

(J) Counters

(K) Timers

(L) Panel Meters

(M) Tacho / Speed / Pulse Meters

(N) Display Units

(O) Sensor Controllers

(P) Switching Mode Power Supplies

(Q) Stepper Motors & Drivers & Controllers

(R) Graphic/ Logic Panels

(S) Field Network Devices

(T) Software

TC Series

● TC4M

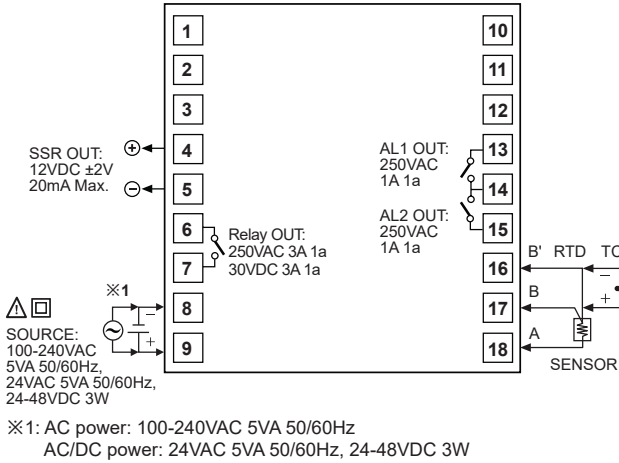

● TC4H/L

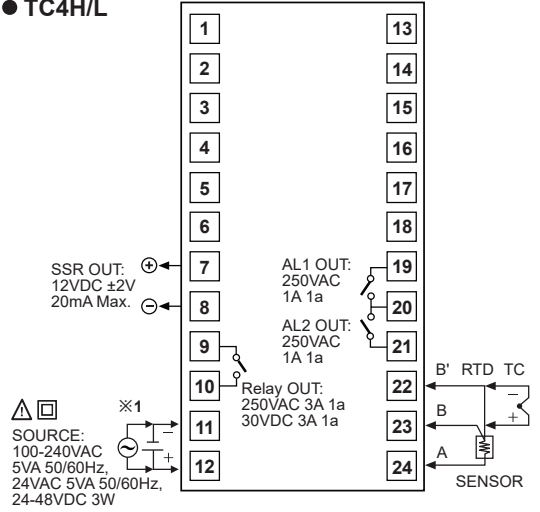

■ Dimensions

(unit: mm)

● TC4S

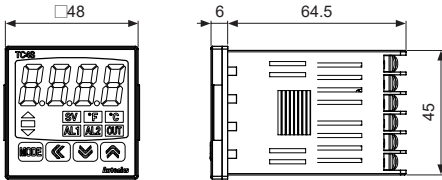

● TC4SP

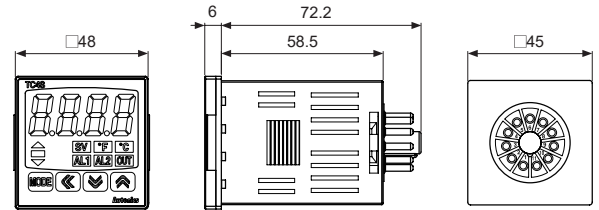

● TC4Y

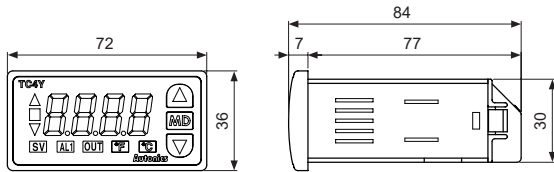

● TC4W

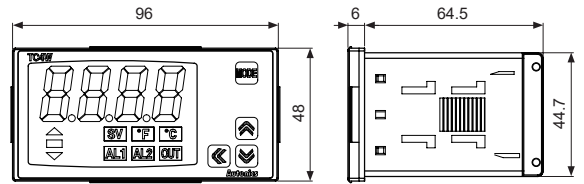

● TC4M

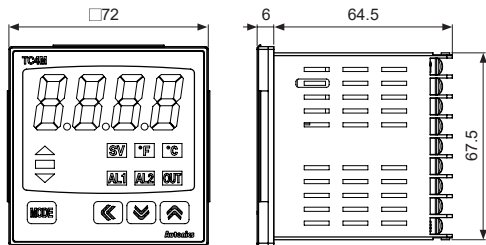

● TC4H

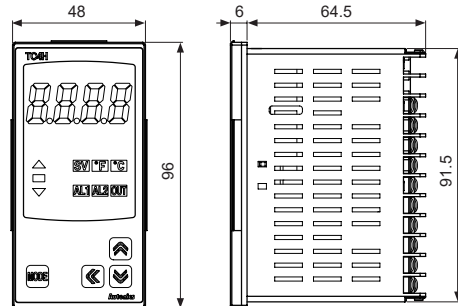

Single Display, PID Control

● TC4L

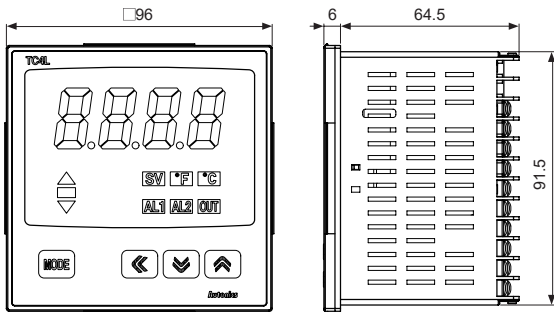

● Panel cut-out

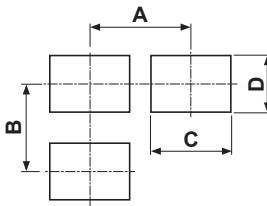

Model \ Size	A	B	C	D
TC4S	Min. 65	Min. 65	45 ^{+0.6} ₀	45 ^{+0.6} ₀
TC4SP	Min. 65	Min. 65	45 ^{+0.6} ₀	45 ^{+0.6} ₀
TC4Y	Min. 91	Min. 40	68 ^{+0.7} ₀	31.5 ^{+0.5} ₀
TC4M	Min. 90	Min. 90	68 ^{+0.7} ₀	68 ^{+0.7} ₀
TC4H	Min. 65	Min. 115	45 ^{+0.6} ₀	92 ^{+0.8} ₀
TC4W	Min. 115	Min. 65	92 ^{+0.8} ₀	45 ^{+0.6} ₀
TC4L	Min. 115	Min. 115	92 ^{+0.8} ₀	92 ^{+0.8} ₀

● Bracket

● TC4S/TC4SP Series

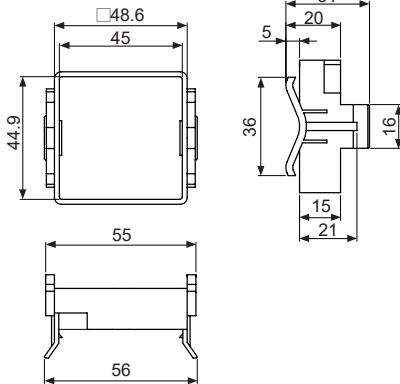

● TC4Y Series

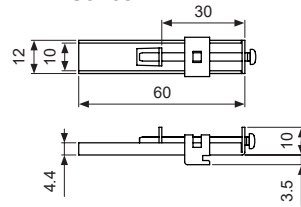

● TC4M, TC4W, TC4H, TC4L Series

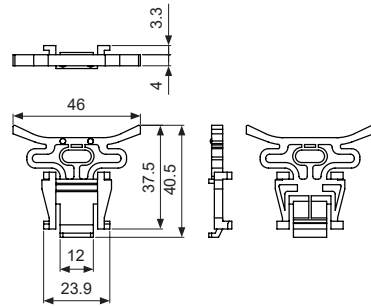

● Terminal cover (sold separately)

● RSA-COVER (48×48mm)

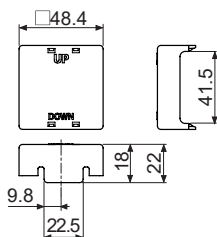

● RMA-COVER (72×72mm)

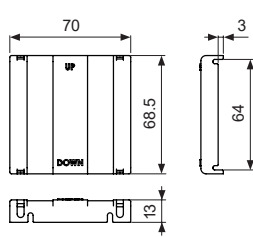

● RHA-COVER (48×96mm)

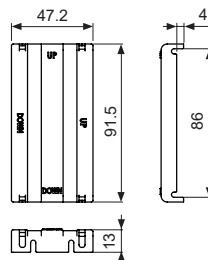

● RLA-COVER (96×96mm)

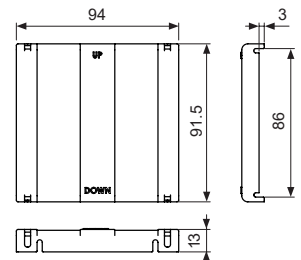

(A) Photoelectric Sensors

(B) Fiber Optic Sensors

(C) Door/Area Sensors

(D) Proximity Sensors

(E) Pressure Sensors

(F) Rotary Encoders

(G) Connectors/
Connector Cables/
Sensor Distribution
Boxes/Sockets

(H) Temperature Controllers

(I) SSRs / Power Controllers

(J) Counters

(K) Timers

(L) Panel Meters

(M) Tacho /
Speed / Pulse
Meters

(N) Display Units

(O) Sensor Controllers

(P) Switching
Mode Power
Supplies

(Q) Stepper Motors
& Drivers
& Controllers

(R) Graphic/
Logic
Panels

(S) Field
Network
Devices

(T) Software

TC Series

Unit Description

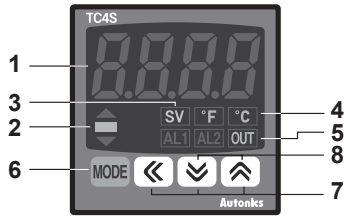

1. Present temperature (PV) display

- RUN mode: Present temperature (PV) display.
- Parameter setting mode: Parameter or parameter setting value display.

2. Deviation indicator, Auto-tuning indicator

It shows current temperature (PV) deviation based on set temperature (SV) by LED.

No.	PV deviation temp.	Deviation display
1	Over 2°C	▲ indicator ON
2	Below ±2°C	■ indicator ON
3	Under -2°C	▼ indicator ON

The deviation indicators (▲, ■, ▼) flash by every 1 sec when operating auto tuning.

3. Set temperature (SV) indicator

Press any front key once to check or change current set temperature (SV), the set temperature (SV) indicator is ON and preset set value is flashed.

4. Temperature unit (°C/°F) indicator

It shows current temperature unit.

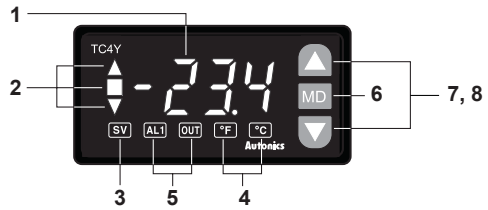

5. Control/alarm output indicator

- OUT: It will turn ON when control output (Main Control Output) is ON.

※In case of CYCLE/PHASE control of SSR drive output, it will turn ON when MV is over 3.0%. (only for AC voltage type)

- AL1/AL2: It will light up when alarm output Alarm 1/ Alarm 2 are on.

6. MODE key

Used when entering into parameter group, returning to RUN mode, moving parameter, and saving setting values.

7. Adjustment

Used when entering into set value change mode, digit moving and digit up/down.

8. FUNCTION key

Press $\left[\text{F} \right] + \left[\text{F} \right]$ keys for 3 sec to operate function (RUN/STOP, alarm output cancel, auto-tuning) set in inner parameter [d1 - d].

※Press $\left[\text{F} \right] + \left[\text{F} \right]$ keys at the same time in set value operation to move digit.

SV Setting

※In case of changing set temperature from 210°C to 250°C.

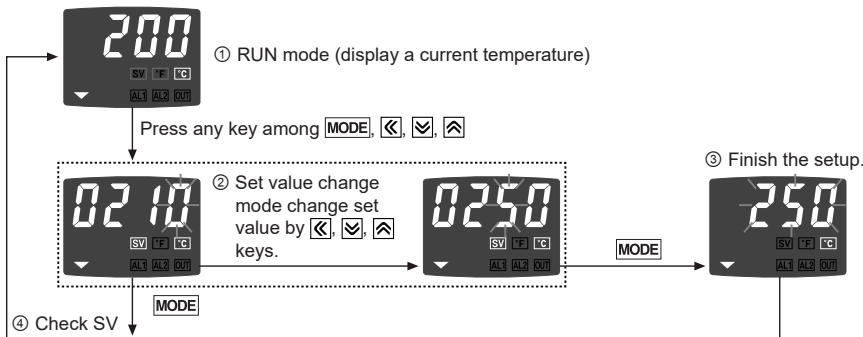

Parameter Reset

Reset all parameters as factory default. Hold the front $\left[\text{F} \right] + \left[\text{F} \right] + \left[\text{F} \right]$ keys for 5 sec, to enter parameter reset [r n l] parameter. Select 'EE5' and all parameters are reset as factory default. Select 'no' and previous settings are maintained. If setting parameter lock [Lo] or processing auto-tuning, parameter reset is unavailable. (except TC4Y Series)

Single Display, PID Control

Parameter Group

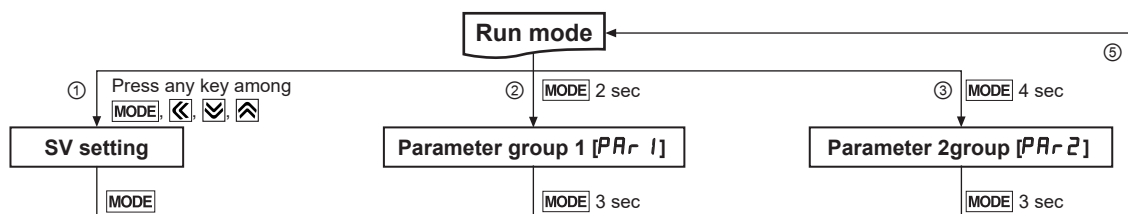

④

AL1	AL1 alarm temperature
AL2	AL2 alarm temperature
At	Auto tuning
P	Proportional band
I	Integral time
d	Derivative time
rSEt	Manual reset (Normal deviation correction)
HYS	ON/OFF control hysteresis

in-t	Input type
Unit	Temperature unit
in-b	Input correction
nAuF	Input digital filter
L-Su	SV low-limit value
H-Su	SV high-limit value
o-Ft	Control output operation
C-nd	Control type
oUt	Control output
SSr.n	SSR drive output method ^{※1}
t	Control cycle
AL-1	AL1 alarm operation mode
AL-2	AL2 alarm operation mode
AHYS	Alarm output hysteresis
LbAt	LBA monitoring time
LbAb	LBA detection range
di-U	Digital input key
Er.nu	Control output MV in case of input break error
LoC	Parameter lock

※1: It is not displayed for AC/DC power model (TC4□□2R).

※If no key entered for 30 sec, it returns to RUN mode automatically and the set value of parameter is not be saved.

※: [] This parameter might not be displayed depending on other parameter settings.

① Press any key once in RUN mode, it advances to set value setting group.

② Press [MODE] key over 2 sec in RUN mode, it advances to parameter group 1.

③ Press [MODE] key over 4 sec in RUN mode, it advances to parameter group 2.

④ First parameter will be displayed on viewer when it advances to the setting group.

⑤ Press [MODE] key over 3 sec in the setting group, it returns to RUN mode.

※Exception: Press [MODE] key once in SV setting group it returns to RUN mode.

※Press [MODE] key again within a sec after return to RUN mode by press [MODE] key over 3 sec, it advances to the first parameter of previous setting group.

※Parameter setup



• Set parameter as the above considering parameter relation of each setting group.

• Check parameter set value after change parameter of setting group 2.

※Indicator model (TC4□-N□N) displays shaded parameter (■) of parameter group 2.

※Alarm operation mode [AL-1, AL-2] parameter of parameter group 2 is decided whether to display according by alarm output type.

※If alarm operation mode [AL-1, AL-2] of parameter group 2 is set to nAu□ / SbA□ / LbA□, AHYS parameter is not displayed.

(A) Photoelectric Sensors

(B) Fiber Optic Sensors

(C) Door/Area Sensors

(D) Proximity Sensors

(E) Pressure Sensors

(F) Rotary Encoders

(G) Connectors/
Connector Cables/
Sensor Distribution
Boxes/Sockets

(H) Temperature Controllers

(I) SSRs / Power Controllers

(J) Counters

(K) Timers

(L) Panel Meters

(M) Tacho / Speed / Pulse Meters

(N) Display Units

(O) Sensor Controllers

(P) Switching Mode Power Supplies

(Q) Stepper Motors & Drivers & Controllers

(R) Graphic/ Logic Panels

(S) Field Network Devices

(T) Software

Single Display, PID Control

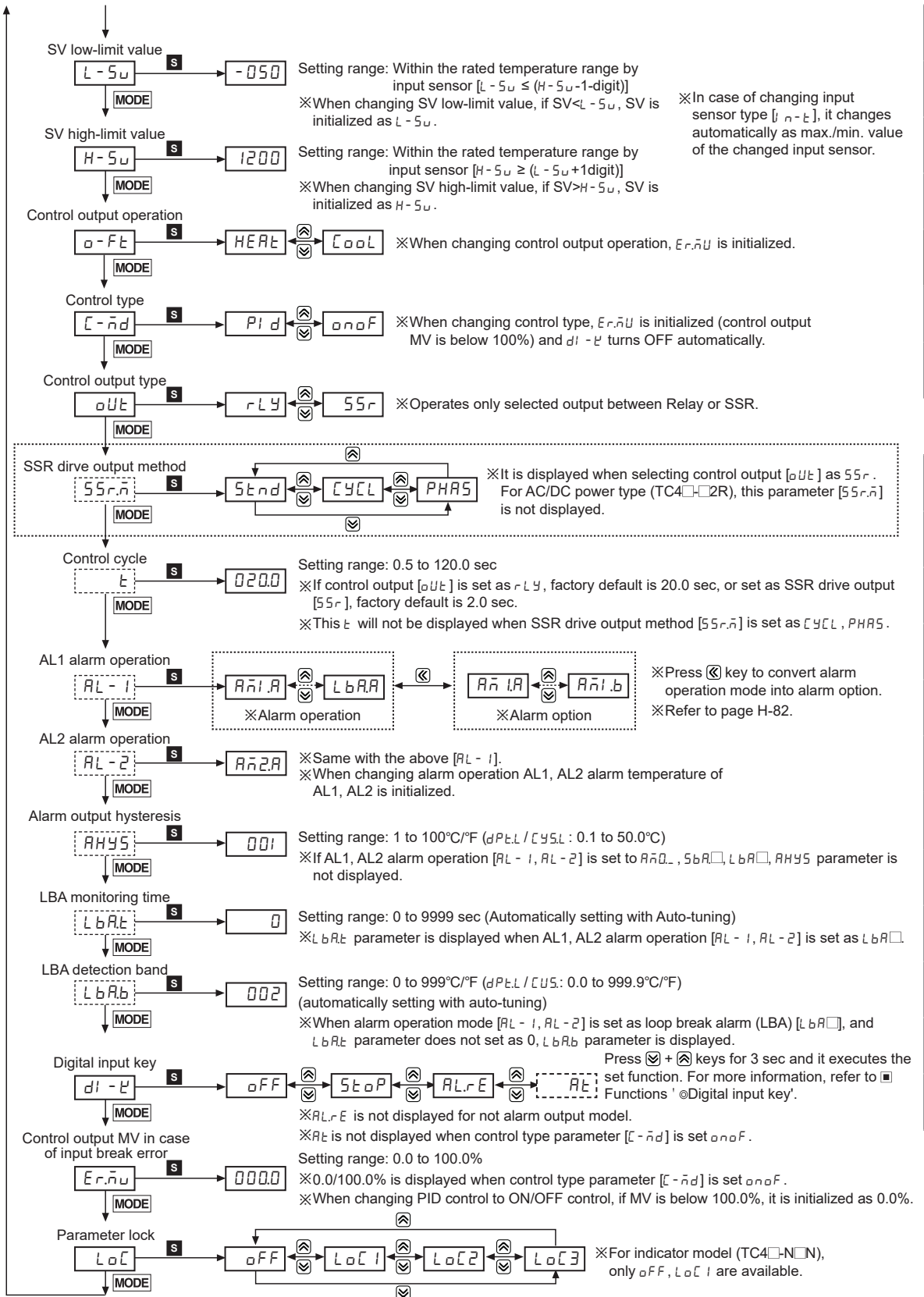

(A)	Photoelectric Sensors
(B)	Fiber Optic Sensors
(C)	Door/Area Sensors
(D)	Proximity Sensors
(E)	Pressure Sensors
(F)	Rotary Encoders
(G)	Connectors/ Connector Cables/ Sensor Distribution Boxes/Sockets
(H)	Temperature Controllers
(I)	SSRs / Power Controllers
(J)	Counters
(K)	Timers
(L)	Panel Meters
(M)	Tacho / Speed / Pulse Meters
(N)	Display Units
(O)	Sensor Controllers
(P)	Switching Mode Power Supplies
(Q)	Stepper Motors & Drivers & Controllers
(R)	Graphic/ Logic Panels
(S)	Field Network Devices
(T)	Software

TC Series

Input Sensor and Temperature Range [i n - t]

Input sensor		Display	Input range (°C)	Input range (°F)
Thermocouple	K(CA)	℄℄℄	-50 to 1200	-58 to 2192
	J(IC)	℄℄℄	-30 to 500	-22 to 932
	L(IC)	℄℄℄	-40 to 800	-40 to 1472
RTD	DPT100Ω	℄℄℄℄	-100 to 400	-148 to 752
		℄℄℄℄	-100.0 to 400.0	-148.0 to 752.0
	Cu50Ω	℄℄℄℄	-50 to 200	-58 to 392
		℄℄℄℄	-50.0 to 200.0	-58.0 to 392.0

Factory Default

SV setting

Parameter	Factory default
-	0

Parameter group 1

Parameter	Factory default
RL 1	1250
RL 2	
RL	oFF
P	0 10.0
i	0000
d	0000
rES℄	0500
HYS	002

Parameter group 2

Parameter	Factory default	Parameter	Factory default
i n - t	℄℄℄	t	0200
Un℄℄	°℄	RL - 1	R℄℄℄
i n - b	0000	RL - 2	R℄℄2℄
℄℄℄℄	000.1	RHYS	000 1
L - S℄	-050	LbRL	0000
H - S℄	1200	LbRb	002
o - F℄	HER℄	d℄ - ℄	5℄oP
℄ - ℄d	P℄d	Er℄℄	0000
oU℄	r℄℄	L℄℄	oFF
55r℄	5℄nd		

※AC/DC power type has no SSR drive output method [55r℄] and supports only ON/OFF output when selecting 55r in control output [oU℄].

Mounting

TC4S/SP (48×48mm) Series

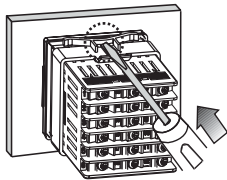

TC4Y (72×36mm) Series

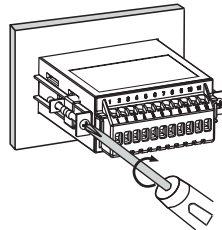

Other Series

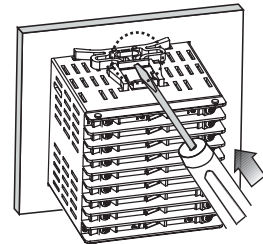

※Mount the product on the panel, fasten bracket by pushing with tools as shown above.
(In case of TC4Y, fasten bolts for bracket.)

Single Display, PID Control

■ Functions

◎ Alarm [AL - 1 / AL - 2]

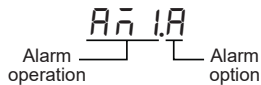

Set both alarm operation and alarm option by combining. Each alarm operates individually in two alarm output models. When the current temperature is out of alarm range, alarm clears automatically. If alarm option is alarm latch or alarm latch and standby sequence 1/2, press digital input key[\boxtimes + \boxtimes] 3 sec, digital input key[$d1$ - $d1$] of Parameter group 2 set as $AL.E$, or turn OFF the power and turn ON to clear alarm.

● Alarm operation

Mode	Name	Alarm operation	Description
$R\bar{n}0$	—	—	No alarm output
$R\bar{n}1$	Deviation high-limit alarm		If deviation between PV and SV as high-limit is higher than set value of deviation temperature, the alarm output will be ON.
$R\bar{n}2$	Deviation low-limit alarm		If deviation between PV and SV as low-limit is higher than set value of deviation temperature, the alarm output will be ON.
$R\bar{n}3$	Deviation high/low-limit alarm		If deviation between PV and SV as high/low-limit is higher than set value of deviation temperature, the alarm output will be ON.
$R\bar{n}4$	Deviation high/low-limit reserve alarm		If deviation between PV and SV as high/low-limit is higher than set value of deviation temperature, the alarm output will be OFF.
$R\bar{n}5$	Absolute value high limit alarm		If PV is higher than the absolute value, the output will be ON.
$R\bar{n}6$	Absolute value low limit alarm		If PV is lower than the absolute value, the output will be ON.
$5bA$	Sensor break Alarm	—	It will be ON when it detects sensor disconnection.
LbA	Loop break Alarm	—	It will be ON when it detects loop break.

※ H: Alarm output hysteresis [RHYS]

● Alarm option

Mode	Name	Description
$R\bar{n}A$	Standard alarm	If it is an alarm condition, alarm output is ON. If it is a clear alarm condition, alarm output is OFF.
$R\bar{n}b$	Alarm latch	If it is an alarm condition, alarm output is ON and maintains ON status. (Alarm output HOLD)
$R\bar{n}C$	Standby sequence 1	First alarm condition is ignored and from second alarm condition, standard alarm operates. When power is supplied and it is an alarm condition, this first alarm condition is ignored and from the second alarm condition, standard alarm operates.
$R\bar{n}d$	Alarm latch and standby sequence 1	If it is an alarm condition, it operates both alarm latch and standby sequence. When power is supplied and it is an alarm condition, this first alarm condition is ignored and from the second alarm condition, alarm latch operates.
$R\bar{n}E$	Standby sequence 2	First alarm condition is ignored and from second alarm condition, standard alarm operates. When re-applied standby sequence and if it is alarm condition, alarm output does not turn ON. After clearing alarm condition, standard alarm operates.
$R\bar{n}F$	Alarm latch and standby sequence 2	Basic operation is same as alarm latch and standby sequence 1. It operates not only by power ON/OFF, but also alarm setting value, or alarm option changing. When re-applied standby sequence and if it is alarm condition, alarm output does not turn ON. After clearing alarm condition, alarm latch operates.

※ Condition of re-applied standby sequence for standby sequence 1, alarm latch and standby sequence 1: Power ON
 Condition of re-applied standby sequence for standby sequence 2, alarm latch and standby sequence 2: Power ON, changing set temperature, alarm temperature [AL 1, AL 2] or alarm operation [AL - 1, AL - 2], switching STOP mode to RUN mode.

◎ Sensor break alarm

The function that alarm output will be ON when sensor is not connected or when sensor's disconnection is detected during temperature controlling. You can check whether the sensor is connected with buzzer or other units using alarm output contact. It is selectable between standard alarm [5bAA], or alarm latch [5bAb].

(A)	Photoelectric Sensors
(B)	Fiber Optic Sensors
(C)	Door/Area Sensors
(D)	Proximity Sensors
(E)	Pressure Sensors
(F)	Rotary Encoders
(G)	Connectors/ Connector Cables/ Sensor Distribution Boxes/Sockets
(H)	Temperature Controllers
(I)	SSRs / Power Controllers
(J)	Counters
(K)	Timers
(L)	Panel Meters
(M)	Tacho / Speed / Pulse Meters
(N)	Display Units
(O)	Sensor Controllers
(P)	Switching Mode Power Supplies
(Q)	Stepper Motors & Drivers & Controllers
(R)	Graphic/ Logic Panels
(S)	Field Network Devices
(T)	Software

◎ Loop break alarm (LBA)

It checks control loop and outputs alarm by temperature change of the subject. For heating control (cooling control), when control output MV is 100% (0% for cooling control) and PV is not increased over than LBA detection band [L b R b] during LBA monitoring time [L b R t], or when control output MV is 0% (100% for cooling control) and PV is not decreased below than LBA detection band [L b R b] during LBA monitoring time [L b R t], alarm output turns ON.

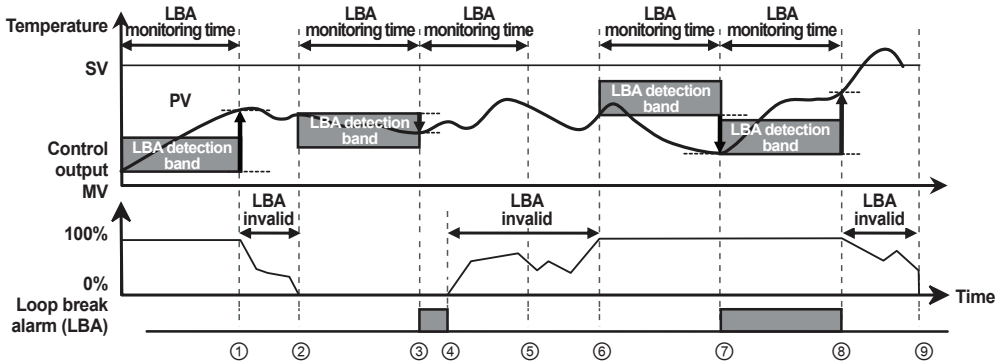

Start control to ①	When control output MV is 0% and PV is not decreased below than LBA detection band [L b R b] during LBA monitoring time [L b R t]
① to ②	The status of changing control output MV (LBA monitoring time is reset.)
② to ③	When control output MV is 0% and PV is not decreased below than LBA detection band [L b R b] during LBA monitoring time [L b R t], loop break alarm (LBA) turns ON after LBA monitoring time.
③ to ④	Control output MV is 0% and loop break alarm (LBA) turns and maintains ON.
④ to ⑥	The status of changing control output MV (LBA monitoring time is reset.)
⑥ to ⑦	When control output MV is 100% and PV is not increased over than LBA detection band [L b R b] during LBA monitoring time [L b R t], loop break alarm (LBA) turns ON after LBA monitoring time.
⑦ to ⑧	When control output MV is 100% and PV is increased over than LBA detection band [L b R b] during LBA monitoring time [L b R t] loop break alarm (LBA) turns OFF after LBA monitoring time.
⑧ to ⑨	The status of changing control output MV (LBA monitoring time is reset.)

※When executing auto-tuning, LBA detection band [L b R b] and LBA monitoring time are automatically set based on auto tuning value. When AL1, AL2 alarm operation [AL - 1, AL - 2] is set as loop break alarm (LBA) [L b R □], LBA detection band [L b R b] and LBA monitoring time [L b R t] parameter is displayed.

◎ SSR drive output function (SSRP function) [55r.n]

- SSRP function is selectable one of standard ON/OFF control, cycle control, phase control by utilizing standard SSR drive output.
- Realizing high accuracy and cost effective temperature control as linear output(cycle control and phase control).
- Select one of standard ON/OFF control [5tnd], cycle control [YCL], phase control [PHAS] at [55r.n] parameter of Parameter group 2. For cycle control, connect zero cross turn-on SSR or random turn-on SSR. For phase control, connect random turn-on SSR.

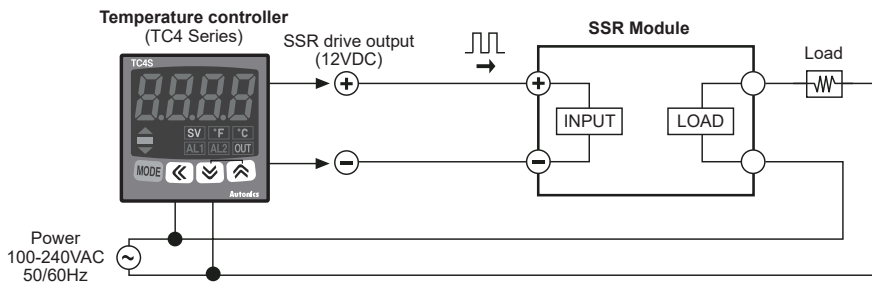

※When selecting cycle or phase control mode, the power supply for load and temperature controller must be the same.

※In case of selecting cycle [YCL] or phase [PHAS] control mode for PID control, control cycle [t] is not allowed to set.

※For AC/DC power model (TC4□-□2R), this parameter [55r.n] is not displayed and it is available only standard control by relay or SSR.

Single Display, PID Control

● Standard ON/OFF control mode [5E n d]

A mode to control the load in the same way as Relay output type.

(ON: output level 100%, OFF: output level 0%)

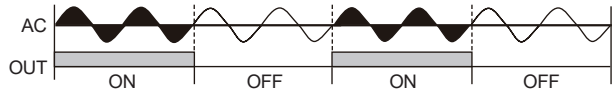

● Cycle control [C Y L L]

A mode to control the load by repeating output ON / OFF according to the rate of output within setting cycle.

Having improved ON / OFF noise feature by Zero Cross type.

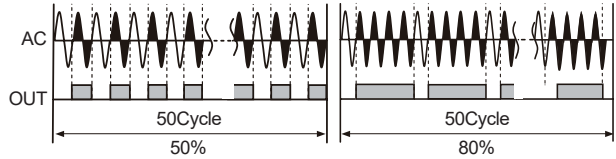

● Phase control [P H A S]

A mode to control the load by controlling the phase within AC half cycle. Serial control is available.

RANDOM Turn-on type SSR must be used for this mode.

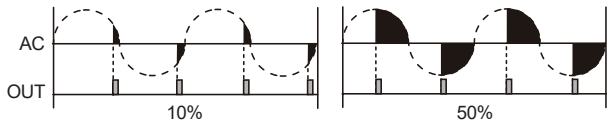

◎ Auto tuning [A E]

- When setting $A E$ parameter to $o n$, front temperature unit display ($^{\circ}C$ or $^{\circ}F$) indicator will be flickering during Auto tuning. After completing auto tuning, temperature unit display indicator returns to normal operation and $A E$ parameter automatically becomes $[o n \rightarrow o f f]$.
- Set as $o f f$ to stop auto tuning.
※It keeps previous P, I, D set values.
- If SV is changed during auto tuning mode, auto tuning is stopped.
- PID time constants figured out through auto tuning function can be changed.
- If control method $[C - \bar{n} d]$ is set to $o n o f f$, no parameters are displayed.
- Finish auto tuning when $[o P E n]$ error occurs during the operation.
※In case of $[o P E n]$ error, auto tuning operation is not applicable.

◎ Input correction [I n - b]

Controller itself does not have errors but there may be error by external input temperature sensor.

E.g.) If actual temperature is $80^{\circ}C$ but controller displays $78^{\circ}C$, set input correction value $[I n - b]$ as 002 and controller displays $80^{\circ}C$.

※As the result of input correction, if current temperature value (PV) is over each temperature range of input sensor, it displays H H H H or L L L L.

◎ Input digital filter [n A L F]

If current temperature (PV) is fluctuating repeatedly by rapid change of input signal, it reflects to MV and stale control is impossible. Therefore, digital filter function stabilizes current temperature value.

- For example, set input digital filter value as 0.4 sec, and it applies digital filter to input values during 0.4 sec and displays this values. Current temperature may be different by actual input value.

◎ Control method selection [C - \bar{n} d]

It is selectable PID, ON/OFF control.

- In case of ON/OFF $[o n o f f]$ mode, Hysteresis $[H Y S]$ parameter is displayed.
- In case of PID $[P I d]$ mode, Proportional band $[P]$, Integral time $[I]$, and Derivative time $[D]$ parameters are displayed.

◎ Hysteresis [H Y S]

- Set control output ON / OFF interval in ON / OFF control mode.

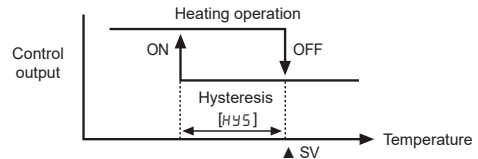

- If Hysteresis is too narrow, hunting (oscillation, chattering) could occur due to external noise.
- In case of ON / OFF control mode, even if PV reaches stable status, there still occurs hunting. It could be due to Hysteresis $[H Y S]$ SV, load's response characteristics or sensor's location. In order to reduce hunting to a minimum, it is required to take into following factors consideration when designing temp. controlling; proper Hysteresis $[H Y S]$, heater's capacity, thermal characteristics, sensor's response and location.

◎ Temperature unit selection [U n I E]

- A function to select display temperature unit
- Unit display indicator will be ON when converting temperature unit.

(A)	Photoelectric Sensors
(B)	Fiber Optic Sensors
(C)	Door/Area Sensors
(D)	Proximity Sensors
(E)	Pressure Sensors
(F)	Rotary Encoders
(G)	Connectors/ Connector Cables/ Sensor Distribution Boxes/Sockets
(H)	Temperature Controllers
(I)	SSRs / Power Controllers
(J)	Counters
(K)	Timers
(L)	Panel Meters
(M)	Tacho / Speed / Pulse Meters
(N)	Display Units
(O)	Sensor Controllers
(P)	Switching Mode Power Supplies
(Q)	Stepper Motors & Drivers & Controllers
(R)	Graphic/ Logic Panels
(S)	Field Network Devices
(T)	Software

◎ Manual reset [r E 5 t]

When selecting P/PD control mode, certain temperature difference exists even after PV reaches stable status because heater's rising and falling time is inconsistent due to thermal characteristics of controlled objects, such as heat capacity, heater capacity. This temperature difference is called offset and manual reset [r E 5 t] function is to set/correct offset.

- When PV and SV are equal, reset value is 50.0%. After control is stable, PV is lower than SV, reset value is over 50.0% or PV is higher than SV, reset value is below 50.0%.
- Manual reset [r E 5 t] by control result

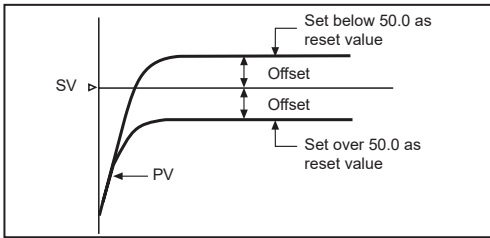

※ Manual reset function is applicable only to P / PD control mode.

◎ Control output MV when input sensor line is broken [E r . n u]

The function to set control output MV in case of open error. Users are able to set by ON/OFF setting or MV setting. It executes control output by set MV regardless of ON/OFF or PID control output.

◎ Digital input key (☒ + ☒ 3 sec) [d l - t]

Parameter		Operation
OFF	o F F	It does not use digital input key function.
RUN/STOP	S t o P	Pauses control output. Auxiliary output (except loop break alarm, sensor break alarm)except Control output operates as setting. Hold the digital input keys for 3 sec to restart.
Clear alarm	R L r E	Clears alarm output by force. (only when alarm option is alarm latch, or alarm latch and standby sequence 1/2 .) This function is applied when present value is out of alarm operation range but alarm output is ON. Alarm operates normally right after clearing alarm.
Auto-tuning	R t	Starts/Stops auto-tuning. This function is same as auto-tuning[R t] of parameter group 1. (You can start auto-tuning [R t] of parameter group 1 and stop it by digital input key.) ※ This parameter R t appears only when control method [c - n d] Parameter group 2 is set as P i d . When control method [c - n d] Parameter group 2 is set as o n o F , this parameter is changed as o F F .

◎ Parameter lock [L o c]

A function to prevent changing SV and parameters of each setting group. Parameter setting values are still possible to check when parameter lock is set.

Display	Description
o F F	Lock off
L o c 1	Lock parameter group 2
L o c 2	Lock parameter group 1, 2
L o c 3	Lock parameter group 1, 2, SV setting

※ o F F , L o c 1 are available only for indicator (TC4□-N□N).

◎ Cool / Heat function [o - F t]

Generally there are two ways to control temperature, one (Heat-function) is to heat when PV is getting down (Heater). The other (Cool-function) is to cool when PV is getting higher (Freezer).

These functions are operating oppositely when it is ON/OFF control or proportional control. But in this case PID time constant will be different due to PID time constant will be decided according to control system when it is PID control.

- Cool-function [c o o L] and heat-function [H E R t] must be set correctly according to the application, if set as opposite function, it may cause a fire. (If set cool-function [c o o L] at heater, it will be maintained ON and it may cause a fire.)
- Avoid changing heat-function to cool-function or cool-function to heat-function when the unit is operating.
- It is impossible to operate both function at once in this unit. Therefore, only one function should be selected only.

◎ SV High/Low limit [H - 5 u / L - 5 u]

- It sets SV high/low limit Limit range of using temperature within temperature range for each sensor, user can set/change set temperature (SV) within SV high limit [H - 5 u] to SV low limit [L - 5 u]. (※ L - 5 u > H - 5 u cannot be set.)
- When changing input type [i n - t], SV high limit [H - 5 u] and SV low limit [L - 5 u] of using temperature will be initialized as max./min. value of sensor temperature range automatically.

◎ Error

Display	Description	Troubleshooting
o P E n	Flashes if input sensor is disconnected or sensor is not connected.	Check input sensor state.
H H H H	Flashes if measured sensor input is higher than temperature range.	When input is within the rated temperature range, this display disappears.
L L L L	Flashes if measured sensor input is lower than temperature range.	

Single Display, PID Control

◎ Output connections

Refer to page H-170 for output.

● Application of relay output type

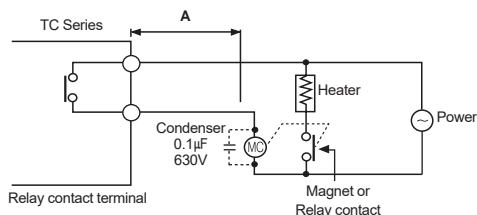

Keep **A** length as long as possible when wiring the temperature controller and the load. If wire length of **A** is short, counter electromotive force which occurs from a coil of magnet switch & power relay may flow in power line of the unit, and it may cause malfunction.

If wire length of **A** is short, please connect mylar condensers 104 (630V) on the both ends of "MC" (magnet coil) to protect electromotive force.

● Application of SSR drive output method

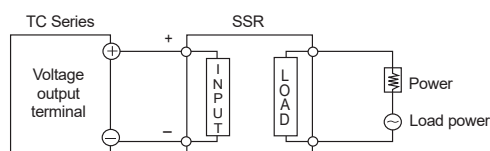

※SSR should be selected by the capacity of load, otherwise, it may short-circuit and result in a fire. Indirect heated should be used with SSR for efficient working.

※Please use a cooling plate or it may cause the capability deterioration, breakdown of SSR for a long usage.

※Refer to page H-70 for phase/cycle control connections.

■ Proper Usage

◎ Simple "error" diagnosis

● When the load (Heater etc) is not operated

Please check operation of the OUT indicator located in front panel of the unit.

If the OUT indicator does not operate, please check the parameter of all programmed mode.

If indicator is operating, please check the output (Relay, SSR drive voltage) after separating output line from the unit.

● When it displays ΔPE_n during operation

This is a warning that external sensor is open.

Please turn off the power and check the wire state of the sensor. If sensor is not open disconnect sensor line from the unit and short the input +, - terminal. Turn on the power of the unit and check the controller displays room temperature.

If this unit cannot display room temperature, this unit is broken. Please remove this unit and contact our service center. (When the input mode is thermocouple, it is available to display room temperature.)

◎ Cautions during use

- Follow instructions in 'Cautions during use'. Otherwise, It may cause unexpected accidents.
- Check the polarity of the terminals before wiring the temperature sensor.
 - For RTD temperature sensor, wire it as 3-wire type, using cables in same thickness and length.
 - For thermocouple (CT) temperature sensor, use the designated compensation wire for extending wire.
- Keep away from high voltage lines or power lines to prevent inductive noise.
 - In case installing power line and input signal line closely, use line filter or varistor at power line and shielded wire at input signal line.
 - Do not use near the equipment which generates strong magnetic force or high frequency noise.
- Install a power switch or circuit breaker in the easily accessible place for supplying or disconnecting the power.
- Do not use the unit for other purpose (e.g. voltmeter, ammeter), but temperature controller.
- When changing the input sensor, turn off the power first before changing.
 - After changing the input sensor, modify the value of the corresponding parameter.
- 24VAC, 24-48VDC power supply should be insulated and limited voltage/current or Class 2, SELV power supply device.
- Make a required space around the unit for radiation of heat.
 - For accurate temperature measurement, warm up the unit over 20 min after turning on the power.
- Make sure that power supply voltage reaches to the rated voltage within 2 sec after supplying power.
- Do not wire to terminals which are not used.
- This unit may be used in the following environments.
 - ①Indoors
 - (in the environment condition rated in 'Specifications')
 - ②Altitude max. 2,000m
 - ③Pollution degree 2
 - ④Installation category II

(A)	Photoelectric Sensors
(B)	Fiber Optic Sensors
(C)	Door/Area Sensors
(D)	Proximity Sensors
(E)	Pressure Sensors
(F)	Rotary Encoders
(G)	Connectors/ Connector Cables/ Sensor Distribution Boxes/Sockets
(H)	Temperature Controllers
(I)	SSRs / Power Controllers
(J)	Counters
(K)	Timers
(L)	Panel Meters
(M)	Tacho / Speed / Pulse Meters
(N)	Display Units
(O)	Sensor Controllers
(P)	Switching Mode Power Supplies
(Q)	Stepper Motors & Drivers & Controllers
(R)	Graphic/ Logic Panels
(S)	Field Network Devices
(T)	Software