

Printed-circuit board connector - MSTB 2,5/10-ST - 1754601

Please be informed that the data shown in this PDF Document is generated from our Online Catalog. Please find the complete data in the user's documentation. Our General Terms of Use for Downloads are valid (<http://phoenixcontact.com/download>)

Plug component, Nominal current: 12 A, Rated voltage (III/2): 320 V, Number of positions: 10, Pitch: 5 mm, Connection method: Screw connection with tension sleeve, Color: green, Contact surface: Tin



The figure shows a 10-position version of the product

Why buy this product

- Well-known connection principle allows worldwide use
- Low temperature rise, thanks to maximum contact force
- Allows connection of two conductors



Key Commercial Data

Packing unit	50 STK
GTIN	 4 017918 028770
GTIN	4017918028770
Weight per Piece (excluding packing)	0.016 kg
Custom tariff number	85366990
Country of origin	Germany

Technical data

Environmental Product Compliance

China RoHS	Hazardous substances above threshold values
	Environmentally Friendly Use Period = 50
	For details go to tab "Downloads", Category "Manufacturer's declaration"

Dimensions

Width	49.95 mm
Pitch	5.00 mm
Dimension a	45 mm

General

Printed-circuit board connector - MSTB 2,5/10-ST - 1754601

Technical data

General

Range of articles	MSTB 2,5/...-ST
Type of contact	Female connector
Number of positions	10
Connection method	Screw connection with tension sleeve
Insulating material group	I
Rated surge voltage (III/3)	4 kV
Rated surge voltage (III/2)	4 kV
Rated surge voltage (II/2)	4 kV
Rated voltage (III/3)	250 V
Rated voltage (III/2)	320 V
Rated voltage (II/2)	630 V
Connection in acc. with standard	EN-VDE
Nominal current I_N	12 A
Nominal cross section	2.5 mm ²
Maximum load current	12 A (with a 2.5 mm ² conductor cross section)
Insulating material	PA
Flammability rating according to UL 94	V0
Internal cylindrical gage	A3
Stripping length	7 mm
Screw thread	M3
Tightening torque, min	0.5 Nm
Tightening torque max	0.6 Nm

Connection data

Conductor cross section solid min.	0.2 mm ²
Conductor cross section solid max.	2.5 mm ²
Conductor cross section flexible min.	0.2 mm ²
Conductor cross section flexible max.	2.5 mm ²
Conductor cross section flexible, with ferrule without plastic sleeve min.	0.25 mm ²
Conductor cross section flexible, with ferrule without plastic sleeve max.	2.5 mm ²
Conductor cross section flexible, with ferrule with plastic sleeve min.	0.25 mm ²
Conductor cross section flexible, with ferrule with plastic sleeve max.	2.5 mm ²
Conductor cross section AWG min.	24
Conductor cross section AWG max.	12
2 conductors with same cross section, solid min.	0.2 mm ²
2 conductors with same cross section, solid max.	1 mm ²
2 conductors with same cross section, stranded min.	0.2 mm ²
2 conductors with same cross section, stranded max.	1.5 mm ²
2 conductors with same cross section, stranded, ferrules without plastic sleeve, min.	0.25 mm ²
2 conductors with same cross section, stranded, ferrules without plastic sleeve, max.	1 mm ²

Printed-circuit board connector - MSTB 2,5/10-ST - 1754601

Technical data

Connection data

2 conductors with same cross section, stranded, TWIN ferrules with plastic sleeve, min.	0.5 mm ²
2 conductors with same cross section, stranded, TWIN ferrules with plastic sleeve, max.	1.5 mm ²
Minimum AWG according to UL/CUL	30
Maximum AWG according to UL/CUL	12

Standards and Regulations

Connection in acc. with standard	EN-VDE
	CSA
Flammability rating according to UL 94	V0

Drawings

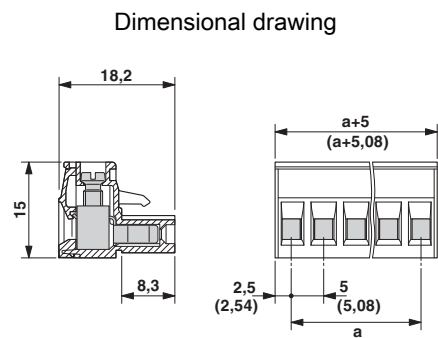
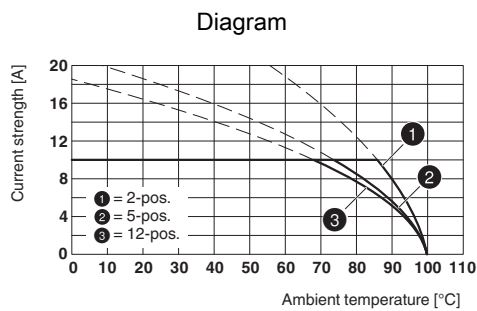

Type: MSTB 2,5/...-ST with MDSTBV 2,5/...-G

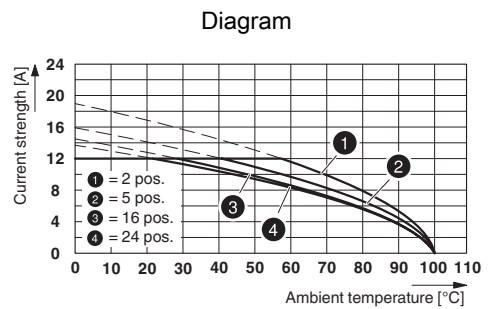
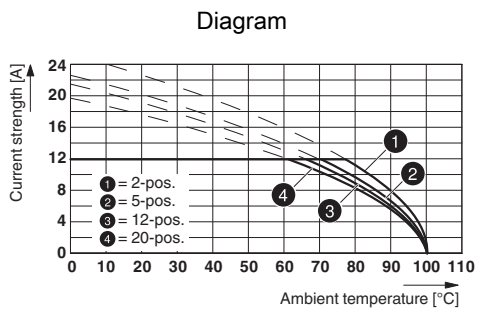

Type: MSTB 2,5/...-ST with MSTBW 2,5/...-G

Type: MSTB 2,5/...-ST with MSTBV 2,5/...-G

Classifications

eCl@ss

eCl@ss 4.0	272607xx
eCl@ss 4.1	27260701
eCl@ss 5.0	27260701
eCl@ss 5.1	27260701
eCl@ss 6.0	27260704

Printed-circuit board connector - MSTB 2,5/10-ST - 1754601

Classifications

eCl@ss

eCl@ss 7.0	27440402
eCl@ss 8.0	27440309
eCl@ss 9.0	27440309

ETIM

ETIM 3.0	EC001121
ETIM 4.0	EC002638
ETIM 5.0	EC002638

UNSPSC

UNSPSC 6.01	30211810
UNSPSC 7.0901	39121409
UNSPSC 11	39121409
UNSPSC 12.01	39121409
UNSPSC 13.2	39121409

Approvals

Approvals

Approvals

CSA / VDE Gutachten mit Fertigungsüberwachung / IECCEB Scheme / EAC / cULus Recognized / EAC

Ex Approvals

Approval details

CSA  13631		
	B	D
mm ² /AWG/kcmil	28-12	28-12
Nominal current I _N	15 A	10 A
Nominal voltage U _N	300 V	300 V

VDE Gutachten mit Fertigungsüberwachung  40004701	
mm ² /AWG/kcmil	0.2-2.5
Nominal current I _N	12 A

Printed-circuit board connector - MSTB 2,5/10-ST - 1754601

Approvals

Nominal voltage UN	250 V
--------------------	-------

IECEE CB Scheme  http://www.iecee.org/ DE1-56062-B1B2	
mm²/AWG/kcmil	0.2-2.5
Nominal current IN	12 A
Nominal voltage UN	250 V

EAC EAC-Zulassung

cULus Recognized http://database.ul.com/cgi-bin/XYV/template/LISEXT/1FRAME/index.htm E60425-19931011		
	B	D
mm²/AWG/kcmil	30-12	30-12
Nominal current IN	15 A	15 A
Nominal voltage UN	300 V	150 V

EAC B.01742

Accessories

Accessories

Bridge

Insertion bridge - EBP 2- 5 - 1733169



Insertion bridge, fully insulated, for connectors with 5.0 or 5.08 mm pitch, no. of positions: 2

Cable housing

Cable housing - KGS-MSTB 2,5/10 - 1783740



Cable housing, Pitch: 0 mm, Number of positions: 10, Dimension a: 50 mm, Color: green

Coding element

Printed-circuit board connector - MSTB 2,5/10-ST - 1754601

Accessories

Coding profile - CP-MSTB - 1734634

Coding profile, is inserted into the slot on the plug or inverted header, red insulating material



Labeled terminal marker

Marker card - SK 5/3,8:FORTL.ZAHLEN - 0804183



Marker card, Card, white, labeled, Horizontal: Consecutive numbers 1 - 10, 11 - 20, etc. up to 91 - (99)100, Mounting type: Adhesive, for terminal block width: 5 mm, Lettering field: 5 x 3.8 mm

Screwdriver tools

Screwdriver - SZS 0,6X3,5 - 1205053



Actuation tool, for ST terminal blocks, insulated, also suitable for use as a bladed screwdriver, size: 0.6 x 3.5 x 100 mm, 2-component grip, with non-slip grip

Additional products

Base strip - MSTBW 2,5/10-G - 1736030

Header, Nominal current: 12 A, Rated voltage (III/2): 320 V, Number of positions: 10, Pitch: 5 mm, Color: green, Contact surface: Tin, Mounting: Wave soldering



Base strip - MSTBV 2,5/10-G - 1753592

Header, Nominal current: 12 A, Rated voltage (III/2): 320 V, Number of positions: 10, Pitch: 5 mm, Color: green, Contact surface: Tin, Mounting: Wave soldering



Printed-circuit board connector - MSTB 2,5/10-ST - 1754601

Accessories

Base strip - MSTB 2,5/10-G - 1754591

Header, Nominal current: 12 A, Rated voltage (III/2): 320 V, Number of positions: 10, Pitch: 5 mm, Color: green, Contact surface: Tin, Mounting: Wave soldering



Base strip - MSTBVA 2,5/10-G - 1755503

Header, Nominal current: 12 A, Rated voltage (III/2): 320 V, Number of positions: 10, Pitch: 5 mm, Color: green, Contact surface: Tin, Mounting: Wave soldering



Base strip - MSTBA 2,5/10-G - 1757543

Header, Nominal current: 12 A, Rated voltage (III/2): 320 V, Number of positions: 10, Pitch: 5 mm, Color: green, Contact surface: Tin, Mounting: Wave soldering



Base strip - MDSTB 2,5/10-G1 - 1762774

Header, Nominal current: 10 A, Rated voltage (III/2): 320 V, Number of positions: 10, Pitch: 5 mm, Color: green, Contact surface: Tin, Mounting: Wave soldering, In combination with MVSTB or FKCV plug components, both an MVSTBW (or FKCVW) and an MVSTBR plug (or FKCVR) must be used. Combination with TMSTBP plug components is not possible!



Base strip - MDSTBV 2,5/10-G1 - 1762923

Header, Nominal current: 10 A, Rated voltage (III/2): 320 V, Number of positions: 10, Pitch: 5 mm, Color: green, Contact surface: Tin, Mounting: Wave soldering, In combination with MVSTB or FKCV plug components, both an MVSTBW (or FKCVW) and an MVSTBR plug (or FKCVR) must be used. Combination with TMSTBP plug components is not possible!



Printed-circuit board connector - MSTB 2,5/10-ST - 1754601

Accessories

Base strip - MSTB 2,5/10-G-LA - 1768260



Header, Nominal current: 12 A, Rated voltage (III/2): 320 V, Number of positions: 10, Pitch: 5 mm, Color: green, Contact surface: Tin, Mounting: Wave soldering

Base strip - SMSTB 2,5/10-G - 1769311



Header, Nominal current: 12 A, Rated voltage (III/2): 320 V, Number of positions: 10, Pitch: 5 mm, Color: green, Contact surface: Tin, Mounting: Wave soldering

Base strip - SMSTBA 2,5/10-G - 1769887



Header, Nominal current: 12 A, Rated voltage (III/2): 320 V, Number of positions: 10, Pitch: 5 mm, Color: green, Contact surface: Tin, Mounting: Wave soldering

Base strip - MSTBA 2,5/10-G-LA - 1770562



Header, Nominal current: 12 A, Rated voltage (III/2): 320 V, Number of positions: 10, Pitch: 5 mm, Color: green, Contact surface: Tin, Mounting: Wave soldering

Base strip - MDSTBVA 2,5/10-G - 1845866



Header, Nominal current: 10 A, Rated voltage (III/2): 320 V, Number of positions: 10, Pitch: 5 mm, Color: green, Contact surface: Tin, Mounting: Wave soldering, The article can be aligned to create different nos. of positions! In combination with MVSTB or FKCV plug components, both an MVSTBW (or FKCVW) and an MVSTBR plug (or FKCVR) must be used. Combination with TMSTBP plug components is not possible!

Printed-circuit board connector - MSTB 2,5/10-ST - 1754601

Accessories

Base strip - MDSTBV 2,5/10-G - 1846014



Header, Nominal current: 10 A, Rated voltage (III/2): 320 V, Number of positions: 10, Pitch: 5 mm, Color: green, Contact surface: Tin, Mounting: Wave soldering, Can be aligned! Mounting flange: Order No. 1836477, 1836480. In combination with MVSTB or FKCV plug components, both an MVSTBW (or FKCVW) and an MVSTBR plug (or FKCVR) must be used. Combination with TMSTBP plug components is not possible!

Base strip - MDSTB 2,5/10-G - 1846441



Header, Nominal current: 10 A, Rated voltage (III/2): 320 V, Number of positions: 10, Pitch: 5 mm, Color: green, Contact surface: Tin, Mounting: Wave soldering, Can be aligned! Mounting flange: Order No. 1736771, 1736768. In combination with MVSTB or FKCV plug components, both an MVSTBW (or FKCVW) and an MVSTBR plug (or FKCVR) must be used. Combination with TMSTBP plug components is not possible!

Base strip - MDSTBA 2,5/10-G - 1846593



Header, Nominal current: 10 A, Rated voltage (III/2): 320 V, Number of positions: 10, Pitch: 5 mm, Color: green, Contact surface: Tin, Mounting: Wave soldering, The article can be aligned to create different nos. of positions! In combination with MVSTB or FKCV plug components, both an MVSTBW (or FKCVW) and an MVSTBR plug (or FKCVR) must be used. Combination with TMSTBP plug components is not possible!

Base strip - MDSTBW 2,5/10-G - 1846894



Header, Nominal current: 10 A, Rated voltage (III/2): 320 V, Number of positions: 10, Pitch: 5 mm, Color: green, Contact surface: Tin, Mounting: Wave soldering, The article can be aligned to create different nos. of positions! In combination with MVSTB or FKCV plug components, both an MVSTBW (or FKCVW) and an MVSTBR plug (or FKCVR) must be used. Combination with TMSTBP plug components is not possible!

Base strip - EMSTBA 2,5/10-G - 1899922



Header, Nominal current: 12 A, Rated voltage (III/2): 320 V, Number of positions: 10, Pitch: 5 mm, Color: green, Contact surface: Tin, Mounting: Press-in technology

Printed-circuit board connector - MSTB 2,5/10-ST - 1754601

Accessories

Base strip - EMSTBVA 2,5/10-G - 1914933



Header, Nominal current: 12 A, Rated voltage (III/2): 320 V, Number of positions: 10, Pitch: 5 mm, Color: green,
Contact surface: Tin, Mounting: Press-in technology

Phoenix Contact 2016 © - all rights reserved
<http://www.phoenixcontact.com>