

Transponder-coded safety switches

Interlocking devices and guard locking devices



EUCHNER

More than safety.

EUCHNER

More than safety.



Headquarters in Leinfelden-Echterdingen



Logistics center in Leinfelden-Echterdingen



Production location in Unterböhringen

Internationally successful – the EUCHNER company

EUCHNER GmbH + Co. KG is a world-leading company in the area of industrial safety technology. EUCHNER has been developing and producing high-quality switching systems for mechanical and systems engineering for more than 60 years.

The medium-sized family-operated company based in Leinfelden, Germany, employs around 750 people around the world.

17 subsidiaries and other sales partners in Germany and abroad work for our international success on the market.

Quality and innovation – the EUCHNER products

A look into the past shows EUCHNER to be a company with a great inventive spirit. We take the technological and ecological challenges of the future as an incentive for extraordinary product developments.

EUCHNER safety switches monitor safety doors on machines and installations, help to minimize dangers and risks and thereby reliably protect people and processes. Today, our products range from electromechanical and electronic components to intelligent integrated safety solutions. Safety for people, machines and products is one of our dominant themes.

We define future safety technology with the highest quality standards and reliable technology. Extraordinary solutions ensure the great satisfaction of our customers. The product ranges are subdivided as follows:

- ▶ Transponder-coded Safety Switches
- ▶ Transponder-coded Safety Switches with guard locking
- ▶ Multifunctional Gate Box MGB
- ▶ Access management systems (Electronic-Key-System EKS)
- ▶ Electromechanical Safety Switches
- ▶ Magnetically coded Safety Switches
- ▶ Enabling Switches
- ▶ Safety Relays
- ▶ Emergency Stop Devices
- ▶ Hand-Held Pendant Stations and Handwheels
- ▶ Safety Switches with AS-Interface
- ▶ Joystick Switches
- ▶ Position Switches





Safety switch CES-A-.5...



- ▶ **Standard housing (EN 60947-5-2)**
- ▶ **One active face, can be repositioned in five directions**
- ▶ **Diagnostics via two LEDs**
- ▶ **Large operating distance**
- ▶ **PL e/category 3 or 4**
- ▶ **ATEX version available**

Details

Available coding options

- ▶ Unicode evaluation
- ▶ Multicode evaluation

Category according to EN ISO 13849-1

Due to two redundantly designed semiconductor outputs (safety outputs) with internal monitoring suitable for:

- ▶ CES-A-C5E-01, category 3/PL e according to EN ISO 13849-1
- ▶ CES-A-C5H-01/CES-A-W5H-01, category 4/PL e according to EN ISO 13849-1

LED indicator

STATE Status
OUT/ERROR Status of safety outputs/diagnostics (combined)

Additional connections

OUT Monitoring output (semiconductor)

ATEX version

There is a version of this device for usage in potentially explosive atmospheres. For explosion protection see marking in the ordering table.

Important: Use only ATEX actuators for ATEX devices.

Notice

On devices with unicode evaluation the number of teach-in operations is restricted to eight.

Further information

- ▶ Dimension drawings see p. 17
- ▶ Accessories and spare parts see p. 17
- ▶ For detailed information, enter the order number for the product in the search box at www.euchner.com.

Ordering table

Safety switch

Series	Version	Order no./item	
CES-A-C5... Unicode		077750 CES-A-C5E-01	For detailed information, enter the order number for the product in the search box at www.euchner.com .
		091458 CES-A-C5H-01	
CES-A-W5... Multicode	097525 CES-A-W5H-01		
CES-A-C5H-01-EX Unicode	 097945 ¹⁾ CES-A-C5H-01-EX		

1) II3G Ex ic nA IIB T5 Gc X, II3D Ex ic tc IIIC T90°C Dc X



Actuator

Series	Design	Typ. operating distance [mm]	Order no./item	
CES-A-BPA	 40 x 40	22	098775 CES-A-BPA	For detailed information, enter the order number for the product in the search box at www.euchner.com .
CES-A-BBA	 42 x 25	20	071840 CES-A-BBA	
CES-A-BCA	 42 x 25 Material: PE-HD	20	088786 CES-A-BCA	
CES-A-BPA-EX-102125	 40 x 40	22	102125 CES-A-BPA-EX-102125	
CES-A-BBA-EX-098158	 42 x 25	20	098158 CES-A-BBA-EX-098158	

M12 8 pin

C05

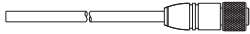
Accessories

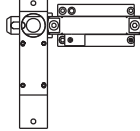
Type	Version	
Connection material	Connecting cable with plug connector 	 Page 103
Bolts	Bolts for housing design C05 	Page 108
Fixing material	Safety screws	Page 116

Dimension drawing

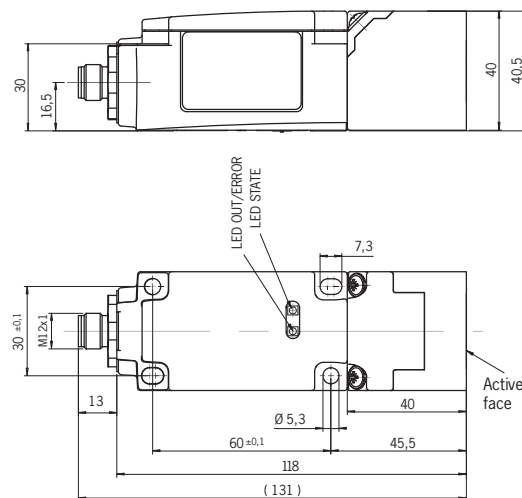

Block diagram

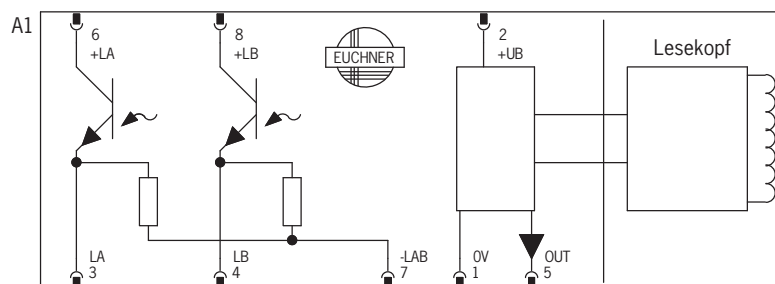

Terminal assignment

Pin	Designation	Function
1	OV	Power supply DC 0 V
2	+UB	Power supply DC 24 V
3	LA	Safety output, channel 1
4	LB	Safety output, channel 2
5	OUT	Monitoring output (door monitoring output)
6	+LA	Channel 1 input
7	-LAB	Common ground for channel 1 and channel 2 inputs
8	+LB	Channel 2 input

Accessories

Connection material

click 6 pin PVC

Connecting cables with snap-on catch

For the connection of:

CES-AP-C.2...-SF



Version		Order no./item	
<div style="display: flex; align-items: center;"> <div style="margin-right: 10px;"> <p>click</p> <p>6 pin</p> <p>PVC</p> </div> <div> <p>Connecting cable with female plug, flying lead, 6 x 0.14 mm²</p> </div> </div>	5m	<p>103556 C-R08F06-06X014PV05,0-ES-103556</p>	<p>For detailed information, enter the order number for the product in the search box at www.euchner.com.</p>
	10m	<p>103557 C-R08F06-06X014PV10,0-ES-103557</p>	
	15m	<p>103558 C-R08F06-06X014PV15,0-ES-103558</p>	
	20m	<p>103559 C-R08F06-06X014PV20,0-ES-103559</p>	
	25m	<p>103560 C-R08F06-06X014PV25,0-ES-103560</p>	

Connecting cables with plug connectors

For the connection of:

CES-IAP-.C04-SK



Version		Order no./item	
<p>M8</p> <p>4 pin</p> <p>PVC</p> <p>Connecting cable with female plug, flying lead, 4 x 0.25 mm²</p>	2m	088812 C-M08F04-04X025PV02,0-ES-088812	<p>For detailed information, enter the order number for the product in the search box at www.euchner.com.</p>
	5m	088813 C-M08F04-04X025PV05,0-ES-088813	
	10m	088814 C-M08F04-04X025PV10,0-ES-088814	
	15m	088815 C-M08F04-04X025PV15,0-ES-088815	
	25m	095035 C-M08F04-04X025PV25,0-ES-095035	
	50m	097100 C-M08F04-04X025PV50,0-ES-097100	
<p>Connecting cable with female plug, flying lead, 4 x 0.25 mm²</p>	10m	084703 C-M08F04-04X025PV10,0-ES-084703	
<p>M8</p> <p>4 pin</p> <p>PUR</p> <p>Connecting cable with female plug, flying lead, 4 x 0.34 mm²</p>	5m	116049 C-M08F04-04X034PU05,0-ES-116049	
	10m	116050 C-M08F04-04X034PU10,0-ES-116050	
	20m	116051 C-M08F04-04X034PU20,0-ES-116051	
	50m	120241 C-M08F04-04X034PU50,0-ES-120241	

M8 8 pin PVC PUR

Connecting cables with plug connectors

For the connection of:

CES-AR-C.2...-SG



CES-IAR-.C04-SG



Version		Order no./item	
<div style="display: flex; flex-direction: column; align-items: center;"> <div style="border: 1px solid black; border-radius: 5px; padding: 2px 5px; margin-bottom: 2px;">M8</div> <div style="border: 1px solid black; border-radius: 5px; padding: 2px 5px; margin-bottom: 2px;">8 pin</div> <div style="border: 1px solid black; border-radius: 5px; padding: 2px 5px;">PVC</div> </div>	<p>Connecting cable with female plug, flying lead, 8 x 0.14 mm²</p>	5m	<p>For detailed information, enter the order number for the product in the search box at www.euchner.com.</p>
		10m	
		15m	
		20m	
<div style="display: flex; flex-direction: column; align-items: center;"> <div style="border: 1px solid black; border-radius: 5px; padding: 2px 5px; margin-bottom: 2px;">M8</div> <div style="border: 1px solid black; border-radius: 5px; padding: 2px 5px; margin-bottom: 2px;">8 pin</div> <div style="border: 1px solid black; border-radius: 5px; padding: 2px 5px;">PUR</div> </div>	<p>Connecting cable with female plug, flying lead, 8 x 0.14 mm²</p>	5m	
		10m	
		20m	

Connecting cables with plug connectors

For the connection of:

CES-AP-C01...-SB	CES-AP-C.2...-SB	CES-IAP...-USB CES-IAP...-USI	CTP...AP...-SII CTP...AR...-SAB	CET-AP...-SI CET-AR...-SG
Terminal plug not aligned. Cable outlet not defined			The following applies to the device installation position shown: Cable outlet C (left) Cable outlet A (right)	

Version	Cable outlet	Order no./item	
Connecting cable with female plug, flying lead, 5 x 0.34 mm² 	5m	- 100183 C-M12F05-05X034PV05,0-MA-100183	For detailed information, enter the order number for the product in the search box at www.euchner.com .
	10m	- 100184 C-M12F05-05X034PV10,0-MA-100184	
	20m	- 100185 C-M12F05-05X034PV20,0-MA-100185	
	50m	- 156064 C-M12F05-05X034PV50,0-MA-156064	
Extension, plug connectors at both ends for connection to decentralized peripheral equipment 	5m	- 100180 C-M12F05-05X034PV05,0-M12M05-100180	
	10m	- 100181 C-M12F05-05X034PV10,0-M12M05-100181	
	20m	- 100182 C-M12F05-05X034PV20,0-M12M05-100182	
Connecting cable with female plug, flying lead, 5 x 0.25 mm² 	10m	C 113190 C-M12F05-05X025PU10,0-MA-113190	
		A 113187 C-M12F05-05X025PU10,0-MA-113187	
Extension, plug connectors at both ends for connection to decentralized peripheral equipment 	10m	C 115566 C-M12F05-05X025PU10,0-M12M05-115566	
		A 115565 C-M12F05-05X025PU10,0-M12M05-115565	

M12 5 pin PUR

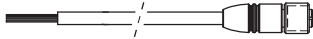
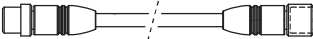
Version	Cable outlet	Order no./item	
Connecting cable with female plug, flying lead, 5 x 0.34 mm² 	5m	113620 C-M12F05-05X034PU05,0-MA-113620	For detailed information, enter the order number for the product in the search box at www.euchner.com .
	10m	113640 C-M12F05-05X034PU10,0-MA-113640	
	20m	113682 C-M12F05-05X034PU20,0-MA-113682	
	30m	122784 C-M12F05-05X034PU30,0-MA-113682	
Extension, plug connectors at both ends for connection to decentralized peripheral equipment 	5m	119932 C-M12F05-05X034PU05,0-M12M05-119932	
	10m	119947 C-M12F05-05X034PU10,0-M12M05-119947	
	20m	119971 C-M12F05-05X034PU20,0-M12M05-119971	

M12

5 pin

PUR

Connecting cables with plug connectors

For the connection of:

CES-AP-C01...-SA
CES-AR-C01...-SA

CES-AR-C.2...-SA

CES-IAR...-USA

ESL...-AR...-SA

CEM...AY...-SA

CTP...AP...-SA
CTP...AR...-SAB

CET-AP...-SA
CET-AR...-SG

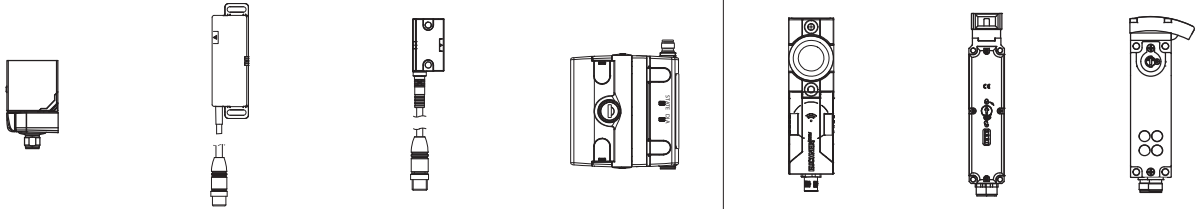





Terminal plug not aligned.
Cable outlet not defined

The following applies to the device installation position shown:

Cable outlet C (left)

Cable outlet A (right)

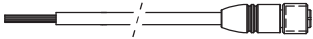
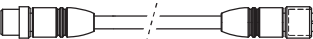

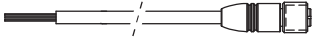
Version	Cable outlet	Order no./item	
 <p>Connecting cable with female plug, flying lead, 8 x 0.25 mm²</p> 	5m	100177 C-M12F08-08X025PV05,0-MA-100177	<p>For detailed information, enter the order number for the product in the search box at www.euchner.com.</p>
	10m	100178 C-M12F08-08X025PV10,0-MA-100178	
	20m	100179 C-M12F08-08X025PV20,0-MA-100179	
	30m	115116 C-M12F08-08X025PV30,0-MA-115116	
<p>Extension, plug connectors at both ends</p> 	1m	123430 C-M12M08-08X025PV01,0-M12F08-123430	
	2m	123431 C-M12M08-08X025PV02,0-M12F08-123431	
	5m	123432 C-M12M08-08X025PV05,0-M12F08-123432	
	10m	123433 C-M12M08-08X025PV10,0-M12F08-123433	
 <p>Connecting cable with female plug, flying lead, 8 x 0.25 mm²</p> 	5m	115112 C-M12F08-08X025PU05,0-MA-115112	
	10m	115113 C-M12F08-08X025PU10,0-MA-115113	
	20m	115114 C-M12F08-08X025PU20,0-MA-115114	
	30m	115257 C-M12F08-08X025PU30,0-MA-115257	

M12 8 pin PUR

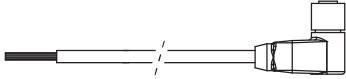
Version	Cable outlet	Order no./item	
<div style="display: flex; align-items: center;"> <div style="margin-right: 20px;"> <p>M12</p> <p>8 pin</p> <p>PUR</p> </div> <div style="text-align: center;"> <p>Connecting cable with female plug, flying lead, 8 x 0.25 mm²</p>  </div> <div style="margin-left: 20px;"> <p>10m</p> </div> </div>	C	<p>113189 C-M12F08-08X025PU10,0-MA-113189</p>	<p>For detailed information, enter the order number for the product in the search box at www.euchner.com.</p>
	A	<p>113188 C-M12F08-08X025PU10,0-MA-113188</p>	
C	<p>120999 C-M12F08-08X025PU20,0-MA-120999</p>		
A	<p>120998 C-M12F08-08X025PU20,0-MA-120998</p>		

Strapping plug/Y-distributors

For the series connection of devices from the output family AR

For the connection of:

CES-AR-C01...-SA



CES-AR-C.2...-SA

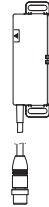

CES-IAR...-USA



ESL...-AR...-SA

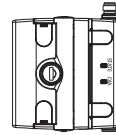







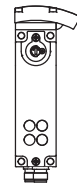

CTP-L-AR...-SAB

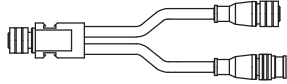

CET-AR...-SG



Version		Order no.		
Strapping plug for AR series connection with Y-distributors (male plug)		097645	For detailed information, enter the order number for the product in the search box at www.euchner.com .	
				
	1x Y-distributor M12 with connecting cable			111696
	2x 			112395
	1x Y-distributor M12			097627
	2x Not suitable for CTP! Instead please use a Y-distributor with connecting cable (see above)			

M12
AR

Passive distribution module

For the series connection of devices from the output family AR

For the connection of:

CES-AR-C01-...-SA

CES-AR-C.2-...-SA

CES-AR-...-USA

ESL-...-AR-...-SA

CTP-L-AR-...-SAB

CET-AR-...-SG

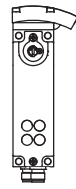
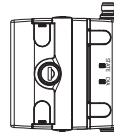
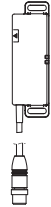

Version		Order no.	
 5x 1x	Passive distribution module	120861 AC-DP-04-SAA-120861	For detailed information, enter the order number for the product in the search box at www.euchner.com .
	Strapping plug for bypassing unused connections on the passive distribution module (male plug)	123340 AC-SP-A1-SA-123340	



Dimension drawing and connection options

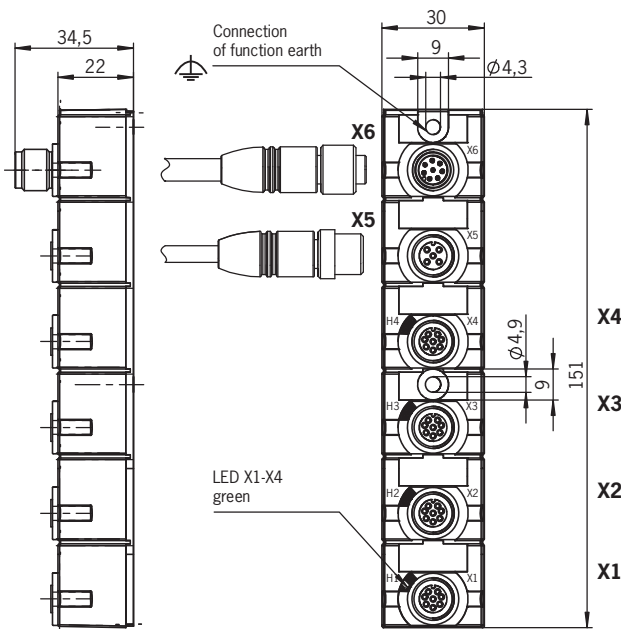

Connection	Use
X1 ... X4	- Connection of AR devices (CES-AR, CET-AR, ...) or - Bypassing using strapping plug if connection is not used or - Connection of a further passive distribution module (important: only on X1)
X5	Provision of the status signals for all AR devices connected
X6	Power supply for the AR devices and transmission of the safety signals

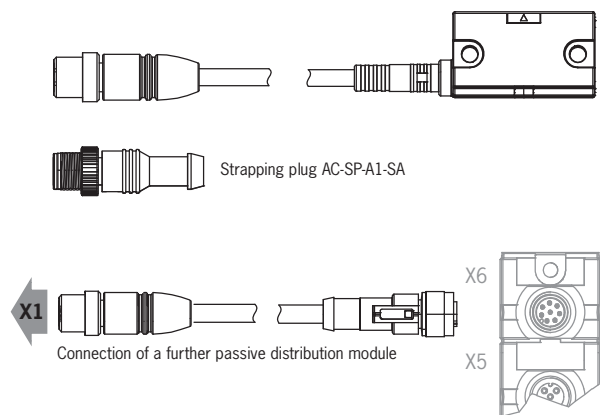



Screened connecting cables with plug connector

For the connection of:

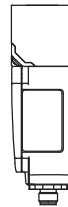
CES-A.5



Version		Order no./item	
<div style="display: flex; align-items: center;"> <div style="margin-right: 10px;"> <p>M12</p> <p>8 pin</p> <p>PVC</p> </div> <div> <p>Connecting cable with female plug, screened ¹⁾, 8 x 0.25 mm²</p>  </div> </div>	5m	<p>077751 C-M12F08-08X025PV05,0-GA-077751</p>	<p>For detailed information, enter the order number for the product in the search box at www.euchner.com.</p>
	10m	<p>077752 C-M12F08-08X025PV10,0-GA-077752</p>	
	15m	<p>077753 C-M12F08-08X025PV15,0-GA-077753</p>	
	20m	<p>077871 C-M12F08-08X025PV20,0-GA-077871</p>	
	25m	<p>077872 C-M12F08-08X025PV25,0-GA-077872</p>	
	50m	<p>077873 C-M12F08-08X025PV50,0-GA-077873</p>	

1) The screen on the connecting cable is connected to the plug housing.

Connecting cable with straight plug connector

For the connection of:

CEM...-AR...-SH



CTP...-AR...-SH



CET-AR...-SH



Version	Order no./item	
1,5m	092761 C-M23F19-19XDIFPU01,5-MA-092761	For detailed information, enter the order number for the product in the search box at www.euchner.com .
3m	092816 C-M23F19-19XDIFPU03,0-MA-092816	
6m	077014 C-M23F19-19XDIFPU06,0-MA-077014	
8m	077015 C-M23F19-19XDIFPU08,0-MA-077015	
10m	092898 C-M23F19-19XDIFPU08,0-MA-077015	
15m	077016 C-M23F19-19XDIFPU15,0-MA-077016	
20m	092726 C-M23F19-19XDIFPU20,0-MA-092726	
25m	092727 C-M23F19-19XDIFPU25,0-MA-092727	
30m	095993 C-M23F19-19XDIFPU30,0-MA-095993	
40m	102490 C-M23F19-19XDIFPU40,0-MA-102490	

M23
19 pin
PUR

Connecting cable with female plug, flying lead

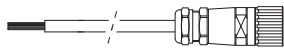

Connecting cable with angled plug connector

For the connection of:

CEM-...-AR-...-SH



CTP-...-AR-...-SH



CET-AR-...-SH

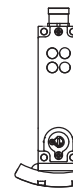

The following applies to the device installation position shown:

Cable outlet C (left)

Cable outlet A (right)



Version	Order no./item Cable outlet		
	C	A	
1,5m	092906 C-M23F19-19XDIFPU01,5- MA-092906	092907 C-M23F19-19XDIFPU01,5- MA-092907	For detailed information, enter the order number for the product in the search box at www.euchner.com .
3m	092908 C-M23F19-19XDIFPU03,0- MA-092908	092909 C-M23F19-19XDIFPU03,0- MA-092909	
6m	077018 C-M23F19-19XDIFPU06,0- MA-077018	085194 C-M23F19-19XDIFPU06,0- MA-085194	
8m	077019 C-M23F19-19XDIFPU08,0- MA-077019	085195 C-M23F19-19XDIFPU08,0- MA-085195	
10m	092901 C-M23F19-19XDIFPU10,0- MA-092901	092902 C-M23F19-19XDIFPU10,0- MA-092902	
15m	077020 C-M23F19-19XDIFPU15,0- MA-077020	085196 C-M23F19-19XDIFPU15,0- MA-085196	
20m	092910 C-M23F19-19XDIFPU20,0- MA-092910	092911 C-M23F19-19XDIFPU20,0- MA-092911	
25m	092912 C-M23F19-19XDIFPU25,0- MA-092912	092913 C-M23F19-19XDIFPU25,0- MA-092913	

M23
19 pin
PUR

Angled female plug with cable, halogen free

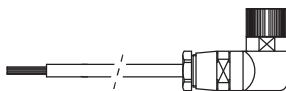

Female plug M23

For the connection of:

CES-AH-C03-...



Version	Comment	Order no.	
<p>Straight female plug</p>	Mating connector for safety switch CES-AH-C03-...	106597	For detailed information, enter the order number for the product in the search box at www.euchner.com .

Female plug M23

For the connection of:

CEM-...-AR-...-SH



CTP-...-AR-...-SH





CET-AR-...-SH



Version	Comment	Order no.	
<p>Straight female plug (for self-assembly)</p>	<p>EF Female plug For conductor cross-section 19 x 0.75 - 1 mm²</p>	074616	For detailed information, enter the order number for the product in the search box at www.euchner.com .
	<p>EF-C1825 Female plug For conductor cross-section 16 x 0.25 - 0.5 mm² + 3 x 0.75 - 1 mm²</p>	077025	
<p>Angled female plug (for self-assembly)</p>	<p>WF Angled female plug For conductor cross-section 19 x 0.75 - 1 mm²</p>	074617	
	<p>WF-C1825 Angled female plug For conductor cross-section 16 x 0.25 - 0.5 mm² + 3 x 0.75 - 1 mm²</p>	077026	
<p>Replacement crimp contacts</p>	For female plugs EF and WF Conductor cross-section 19 x 0.75 - 1 mm ²	094309	
	For female plugs EF-C1825 and WF-C1825 Conductor cross-section 16 x 0.25 - 0.5 mm ² + 3 x 0.75 - 1 mm ²	094310	





Connection kits

For connection to AR evaluation unit CES-AR-AES-12

Version	Comment	Order no.	
 Connection kits for evaluation unit CES-AR-AES-12	Plug-in screw terminals	104776 CES-EA-TC-AK08-104776	For detailed information, enter the order number for the product in the search box at www.euchner.com .
	Plug-in spring terminals	112629 CES-EA-TC-KK08-112629	







Teach-in adapter

For connection to safety switch CET

Version	Comment	Order no.	
 Teach-in adapter AC-TA-A-....	 For safety switch CET1-AR/CET3-AR	125496 AC-TA-A1-SG-125496	For detailed information, enter the order number for the product in the search box at www.euchner.com .
	For safety switch CET2-AR/CET4-AR	125497 AC-TA-A2-SG-125497	
	 For safety switch CET1/CET3	122748 AC-TA-A1-SH-122748	
	For safety switch CET2/CET4	122749 AC-TA-A2-SH-122749	

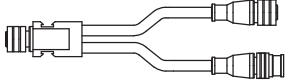
Adapter for connection to IP 67 field modules

Adapter for AP devices with plug connectors 2 x M12, 5-pin, with monitoring output (e.g. CET-AP with wiring diagram B) for connection to field modules with sockets M12, 5-pin.
The adapter makes it possible to operate the guard locking solenoid via a safe output module and to route the monitoring contact OUT D to an input module on a control system.

Designation	Version	Order no.	
  Adapter for connection to IP 67 field modules 	 (socket)   (plug)	124516 AC-YD-V0,2-SBB-124516	For detailed information, enter the order number for the product in the search box at www.euchner.com .

Bolts

C01 C05

Bolts for housing design C01/C05

Notice: The actuators are included with these bolts.

For mounting:

CES-AP-C01-...
CES-AR-C01-...

CES-A.5...

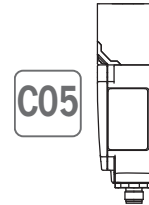

Designation	Detent mechanism/ door gap	Material	Version	Order no.	
<p>Bolt CES-A-C</p> <p>Bolt CES-A-C/F</p>	Closed position: ball detent mechanism Open position: none/ door gap: 15 mm	Steel	For doors hinged on the right or left	082220	For detailed information, enter the order number for the product in the search box at www.euchner.com .
	Closed position: ball detent mechanism Open position: detent knob/ door gap: 15 mm	Steel	Emergency release lever, for doors hinged on the right or left	098357	

Bolt sets (complete with switch)

Notice: The actuators are included with these bolts.

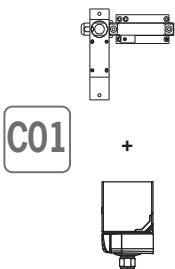
Designation	Detent mechanism/ door gap	Material	Version	Order no.	
 <p>C01 + Bolt CES-AC...C01</p>	Closed position: ball detent mechanism/ door gap: 7 mm	Steel	Bolt with pre-assembled safety switch CES-AR-C01-AH-SA-098941 for doors hinged on the right or left	109358	<p>For detailed information, enter the order number for the product in the search box at www.euchner.com.</p>
	Closed position: ball detent mechanism/ door gap: 7 mm	Steel	Bolt with pre-assembled safety switch CES-AP-C01-AH-SB-111145 for doors hinged on the right or left	113986	
	Closed position: ball detent mechanism Open position: detent knob/ door gap: 15 mm	Steel	Bolt with pre-assembled safety switch CES-AR-C01-AH-SA-098941 and safety plate ¹⁾ for doors hinged on the right or left	104028	
	Closed position: ball detent mechanism Open position: detent knob/ door gap: 15 mm	Steel	Bolt with pre-assembled safety switch CES-AR-C01-AH-SA-098941 and safety plate ¹⁾ for doors hinged on the right or left, emergency release lever	105619	
	Closed position: ball detent mechanism Open position: detent knob/ door gap: 7 mm	Steel	Bolt with pre-assembled safety switch CES-AP-C01-AH-SB-111145 and safety plate for doors hinged on the right or left, emergency release lever	124401	
	Closed position: ball detent mechanism Open position: detent knob/ door gap: 15 mm	Steel	Bolt with pre-assembled safety switch CES-AP-C01-AH-SB-111145 and safety plate ¹⁾ for doors hinged on the right or left, emergency release lever	116246	
	Closed position: ball detent mechanism Open position: detent knob/ door gap: 15 mm	Steel	Bolt with pre-assembled safety switch CES-AP-C01-CH-SB-111708 and safety plate ¹⁾ for doors hinged on the right or left, emergency release lever	115732	
	Closed position: ball detent mechanism/ door gap: 15 mm	Steel	Bolt with pre-assembled safety switch ¹⁾ CES-AP-C01-CH-SB-106798 for doors hinged on the right or left	110355	
Closed position: ball detent mechanism/ door gap: 15 mm	Steel	Bolt with pre-assembled safety switch ¹⁾ CES-AP-C01-CH-SB-111708 for doors hinged on the right or left	110354		

1) The safety plate prevents the use of a padlock in closed bolt position.

Bolts for housing design C04

Notice: The actuators are **not** included with these bolts.

For mounting:

CES-IAP-.-C04-...
CES-IAR-.-C04-...

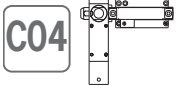

Designation	Detent mechanism/ door gap	Material	Version	Order no.	
 <p>Bolt BTC-CES04-...</p>	Closed position: spring catch Open position: none/ door gap: 7 mm	Aluminum	For doors hinged on right and left, can be locked in open position with padlocks	121646	For detailed information, enter the order number for the product in the search box at www.euchner.com .
	Closed position: spring catch Open position: detent knob/ door gap: 7 mm	Aluminum	Emergency release lever, for doors hinged on right and left, can be locked in open position with padlocks	123583	

Bolts for housing design CTP

Notice: The actuators are included with these bolts.

For mounting:

CTP-...-...



Designation	Detent mechanism/ door gap	Material	Version	Order no.	
Bolt CTP-AC	None/ door gap: 15 mm	Steel	For doors hinged on right and left, can be locked in open position with padlocks	123653	For detailed information, enter the order number for the product in the search box at www.euchner.com .
Bolt CTP-ACF	Closed position: none Open position: detent knob/ door gap: 15 mm	Steel	Emergency release lever, for doors hinged on right and left, can be locked in open position with padlocks	123655	
Bolt CTP-AC-C2308	None/ door gap: 15 mm	Steel	For doors hinged on the right and left; bolt can be opened outward and inward (no end stop)	137354	
Bolt BTC-CTP-S-TH-00-X	None/ door gap: 15 mm	Die-cast aluminum	For doors hinged on right and left, can be locked in open position with padlocks	123659	
Bolt BTC-CTP-S-TH-01-F	Closed position: none Open position: detent knob/ door gap: 15 mm	Die-cast aluminum	Emergency release lever for doors hinged on the right and left; can be locked in open position with padlocks	123660	
Bolt CTP-GFK	None/ door gap: 7 mm	Plastic	For doors hinged on right and left; can be locked in open position with padlocks	123657	
Bolt CTP-GFK-F	Closed position: none Open position: detent knob/ door gap: 7 mm	Plastic	Emergency release lever, for doors hinged on right and left; can be locked in open position with padlocks	123658	
Switch bracket	–	Plastic	For safety switch CTP	096613	

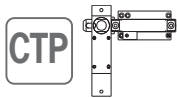



Bolts for housing design CET

Notice: - Actuators are **not** included with these bolts.
 - Cover (protection against tampering) for CET actuators included.

For mounting:

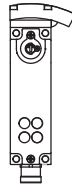
CET-A-...









Designation	Detent mechanism/ door gap	Material	Version	Order no.	
Bolt CET-A-C	None/ door gap: 15 mm	Steel	For doors hinged on the right or left	104309	For detailed information, enter the order number for the product in the search box at www.euchner.com .
Bolt CET-A-C/F	Closed position: none Open position: detent knob/ door gap: 15 mm	Steel	For doors hinged on the right or left, for CET with escape release	106172	
Bolt CET-A-C/F-C2282	Closed position: none Open position: detent knob/ door gap: 15 mm	Steel, guide strip made of stainless steel	For doors hinged on the right or left, for CET with escape release	106350	
Bolt CET-A-C-C2308	None/ door gap: 15 mm	Steel	For doors hinged on the right or left. Bolt can be opened outward and inward (no end stop).	109672	



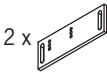
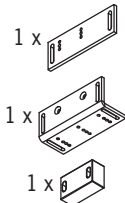





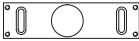

Fixing material

Mounting sets/mounting plates

Series	Use	Order no./item	
Mounting set AM-SET-PP 	For safety switch and actuator design C04 Set comprising: 2 x mounting plates	119690 AM-SET-PP-119690	For detailed information, enter the order number for the product in the search box at www.euchner.com .
C04 Mounting set AM-SET-PPB 	For safety switch and actuator design C04 Set comprising: 1 x mounting plate 1 x angle mounting plate 1 x spacer	119694 AM-SET-PPB-119694	
C40 Mounting bracket AM-B-126230 	For actuator CEM-...-C40	126230 AM-B-126230	
Mounting bracket AM-B-126231 	For safety switch CEM-...-C40	126231 AM-B-126231	
Angle mounting plate EMP-SB 	For safety switch CTP	093456 EMP-SB	
CTP Mounting plate EMP-B2 	For actuator CTP	093458 EMP-B2	
Mounting plate EMP-B1 	For actuator CTP and actuator CET	093457 EMP-B1	
Mounting plate AM-P 	For safety switch CTP	126026 AMP-126026	

Series	Use	Order no./item	
Mounting plate EMP-L-CET 	For safety switch CET	106695 EMP-L-CET	For detailed information, enter the order number for the product in the search box at www.euchner.com .
Mounting plate EMP-B-CET 	For actuator CET	106694 EMP-B-CET	
Mounting plate EMP-B1 	For actuator CTP and actuator CET	093457 EMP-B1	
Mounting plate AM-P 	For safety switch CET	126399 AM-P-126399	
Mounting plate AM-P 	For actuator CET	126400 AM-P-126400	
Mounting plate with handle 	Can be combined with mounting plates AM-P-126399 and AM-P-126400	126398 AM-P-126398	





CET













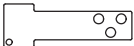

Miscellaneous accessories

Safety screws

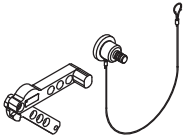
Fixing material/screw size	Version/usage	Packaging unit [qty.]	Order no.
Safety screws, stainless steel M4 x 14 (small head)	Actuators CES-A-BBA, CES-A-BCA	20	071863
Safety screws, stainless steel M4 x 14 (large head)	Safety switch CES-...-C.2, actuator CES-A-BLN.2 and actuator CTP (straight/angled)	100	086232
Safety screws, stainless steel M4 x 20	Safety switch CES-AP-...-C04 and actuator CES-A-BBN-C04-...	20	116978
Safety screws, stainless steel M5 x 10	Safety switch CES-...-C01, actuator CES-A-BPA and hinged actuator CTP (left/right)	100	073455
Safety screws M5 x 16	Actuators CES-A-BRN, CET-A-BWK and actuator A-C40	100	073456
Safety screws M5 x 25	Hinged actuator CTP (top/bottom)	100	073457

Miscellaneous accessories

Designation	Use	Version	Order no.
C04 ATEX housing protection 	For safety switch CES-C04	–	137528 AM-C-C04-EX-137528
C40 Lockout bar 	For safety switch design C40	–	123625 AE-L-C40-123625
CTP Mechanical key release 	For safety switch CTP	Identical locking, including two keys	086236
		Identical locking, key removable only in <i>unlocked</i> position, including two keys	109212
		Unique locking, including two keys	084177
		Identical locking, key removable in <i>locked</i> position, including two keys	121917
CTP Replacement key	For mechanical key release, identical locking	Two keys, identical locking	099434
CTP Release 	For safety switch CTP	Resetting	103110
CTP Emergency unlocking 	For safety switch CTP	–	099877
CTP Lead seal kit	For emergency unlocking	–	087256

	Designation	Use	Version	Order no
CTP	Wire front release 	For safety switch CTP	Resetting, sheath length 2 m (rope length 6 m)	097747 AE-B-A1-02,0F-097747
	Resetting, sheath length 3 m (rope length 6 m)		111233 AE-B-A1-03,0F-111233	
	Handle for wire front release 	Suitable for all safety switches with wire front release		099795 AY-HDL-099795
			124204 AY-HDL-124204	
	Lockout bar 	For safety switch CTP	-	123411
	Lockout bar 	For actuator CET	Suitable for shackle diameter 5 mm - 6 mm	122609 AE-L-CET-122609
	Lockout bar 	For actuator CET	Suitable for shackle diameter 5 mm - 9 mm	156429 AE-L-CET-156429
	Holder for lockout bar 	For lockout bar AE-L-CET-156420	Including wire rope and ring to hang the wire rope onto the lockout bar	156338 AY-CHN-A1-156338
CET	Lockout bar + holder set 	For actuator CET	Suitable for shackle diameter 5 mm - 9 mm. Holder including wire rope and ring to hang the wire rope onto the lockout bar.	155865 AE-SET-LCHN-A1-155865
	Mechanical key release 	For safety switch CET	Identical locking, including two keys	098850
	Replacement key	For mechanical key release, identical locking	Two keys, identical locking	099434
	Emergency unlocking 	For safety switch CET	Latching in both positions	103714
	Lead seal kit	For emergency unlocking	-	087256
	Cover 	For safety switch CET and actuator CET	Door hinge right	098808
	Cover 		Door hinge left	098807
	Cover 	For actuator CET	Horizontal and vertical fastening option on the actuator	124979 AM-C-124979