

## Features

- Replacement for R-78Axx-1.0SMD series
- RoHS 6/6 Conform (100% Lead Free)
- High Reflow Temperature SMD Package
- Adjustable Output Voltage
- Short circuit protection, Thermal shutdown
- Remote On/Off Control
- Very Low Shutdown Current

### Description

The R-78Axx-1.0SMD series are manufactured without lead and meet the requirements for RoHS 6/6 as well as the increased reflow soldering temperatures associated with vapour phase soldering, making these high efficiency switching regulators ideally suited to modern pick-and-place mass production. The efficiency of up to 94% means that very little energy is wasted as heat. The additional features of remote on/off control and adjustable output voltages will find many uses in the battery-powered, industrial, medical and automotive markets.

### Selection Guide

Part Number SMD	Input Range (V)	Output Voltage (V)	Adjust Range (V)	Output Current (A)	Efficiency	
					Min. Vin (%)	Max. Vin (%)
R-78AA1.5-1.0SMD	4.75 – 18	1.5	fixed	1.0	77	73
R-78AA1.8-1.0SMD	4.75 – 18	1.8	1.5~3.0	1.0	82	76
R-78AA2.5-1.0SMD	4.75 – 18	2.5	1.5~3.0	1.0	87	81
R-78AA3.3-1.0SMD	4.75 – 18	3.3	3.0~5.5	1.0	90	84
R-78AA5.0-1.0SMD	6.5 – 18	5.0	3.0~5.5	1.0	94	89

### Specifications ( typical at 25°C, 10% minimum load, unless otherwise specified )

Characteristics	Conditions	Min.	Typ.	Max.
Input Voltage Range	See Table	4.75V		18.0V
Output Voltage Range	See Table	1.5V		5.5V
Output Current	All Series	0mA*		1000mA
Output Current Limit	All Series			5500mA
Short Circuit Input Current	Vin = 12V			120mA
Internal Power Dissipation				0.4W
Short Circuit Protection			Continuous, automatic recovery	
Output Voltage Accuracy	100% Load		±2%	±3%
Adjustable Voltage Range	See Table 1			±50%
Line Voltage Regulation (Vin = min to max at full load)			0.2%	0.4%
Load Regulation (10% to 100% full load)			0.7%	1.0%
Dynamic Load Stability	100% <> 50% load, 25mA/μs		±85mV	±100mV
Ripple & Noise (20MHz BW)			20mVp-p	30mVp-p
Temperature Coefficient	-40°C~+85°C ambient			0.015%/°C
Max capacitance Load	with normal start-up time, no external components			470μF
	with <1 second start up time + diode protection circuit			6800μF
Switching Frequency		335kHz	385kHz	435kHz
Quiescent Current	Vin = min. to max. at 0% load		5mA	7mA
ON/OFF Remote Control Pin Drive Current	ON: Open or 1.6V < Vr < 5V OFF: GND or 0 < Vr < 1.6V			Ir = 1.8μA typ
Converter Input Current (valid for Vr < 1.6V)			20μA	35μA
Remote On/Off Threshold Voltage (Vr rising)		2.4V	2.6V	2.8V
Remote On/Off Voltage Hysteresis			250mV	
Operating Temperature Range		-40°C		+85°C
Switch On/Off Time	(using Remote On/Off Control)			50ms
Operating Case Temperature				+100°C
Storage Temperature Range		-55°C		+125°C
Case Thermal Impedance				70°C / W
Thermal Shutdown	Internal IC junction			+160°C
Case Material				Non-Conductive Black Plastic
Potting Material				Epoxy (UL94V-0)

cont.

**INNOLINE**  
DC/DC-Converter  
with 3 year Warranty

**RECOM**

**1.0 AMP**  
**SMD**  
**Single Output**



**EN-60950-1 Certified**

**R-78AA-1.0**

## Derating-Graph (Ambient Temperature)

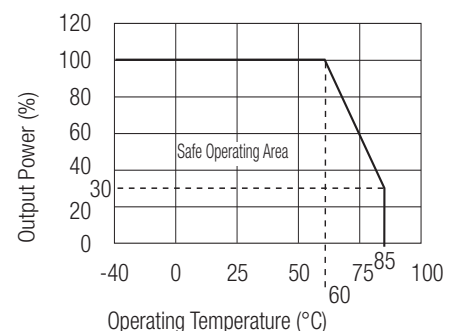

## Standard Application Circuit

EMC	Conducted Emissions (with filter)	EN55022	Class B
	Radiated Emissions (with filter)	EN55022	Class B
	ESD	EN61000-4-2	Class A
	Radiated Immunity	EN61000-4-3	Class A
	Fast Transient	EN61000-4-4	Class A
	Conducted Immunity	EN61000-4-6	Class A
	Magnetic Field Immunity	EN61000-4-8	Class A
Safety Certification	Report: SPCLVD 1301026-1	EN-60950-1:2006 + A12:2011	
Package Weight			1.7g
Packing Quantity			33 pcs per Tube 250 pcs per Reel
MTBF (+25°C)	Detailed Information see Application Notes chapter "MTBF"	13338~21070 x 10 <sup>3</sup> hours	
(+71°C)		using MIL-HDBK 217F	3880~6769 x 10 <sup>3</sup> hours

\*Note: Operation under no load will not damage these devices, however they may not meet all specifications. A minimum load of 10mA is recommended

## Characteristics

### Efficiency

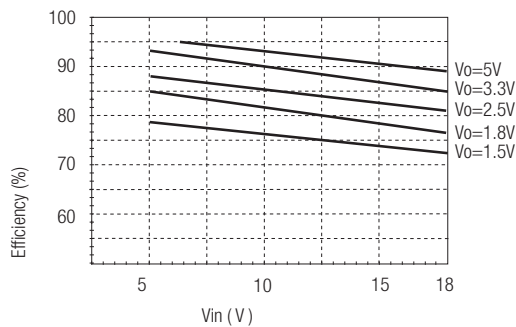

Efficiency Vs Vin (Full Load)

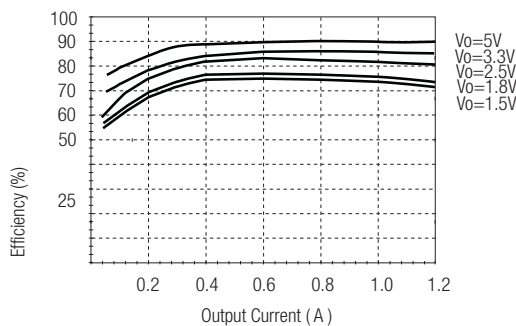

Efficiency Vs Load (Vin=Max)

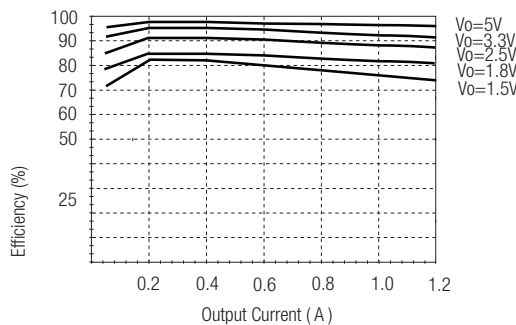

Efficiency Vs Load (Vin=Min)

### Ripple

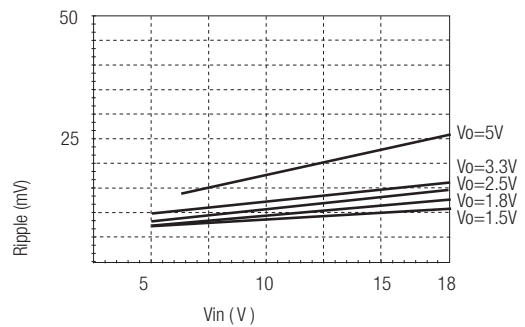

Ripple Vs Vin ( Full Load )

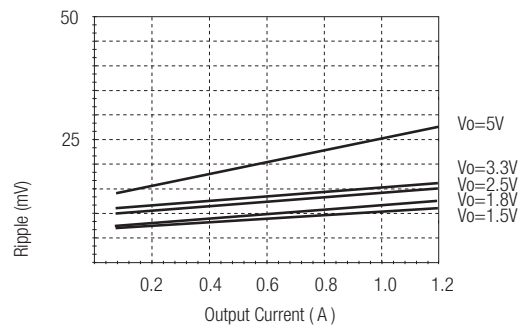

Ripple Vs Load (Vin=Max)

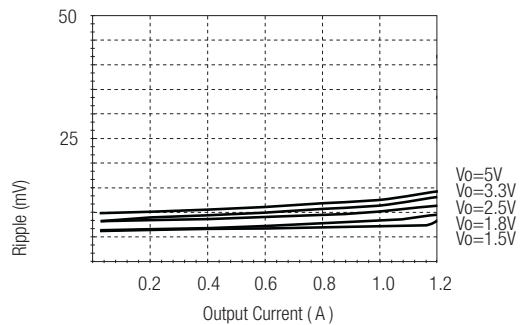

Ripple Vs Load (Vin=Min)

Standard Application Circuit

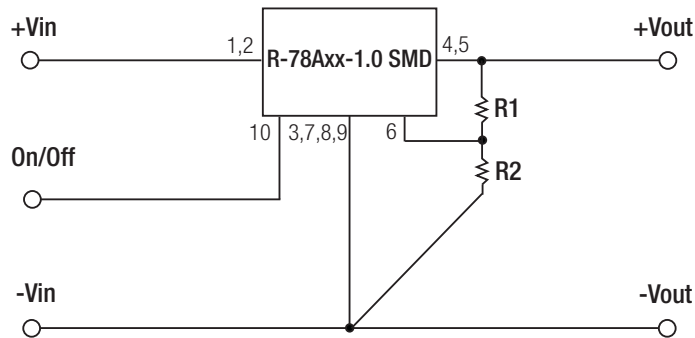

Application Examples

3.3V/5V Selectable 1A Power Supply

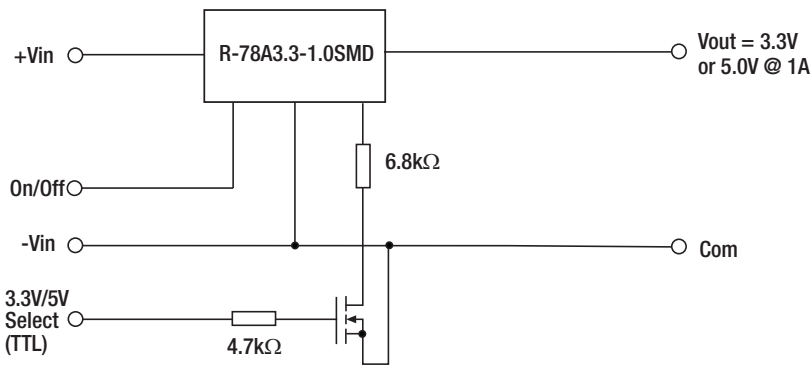

Optional Protection Circuit

Optional Protection 1:

Add a blocking diode to Vout if current can flow backwards into the output, as this can damage the converter when it is powered down.

The diode can either be fitted across the device if the source is low impedance or fitted in series with the output (recommended).

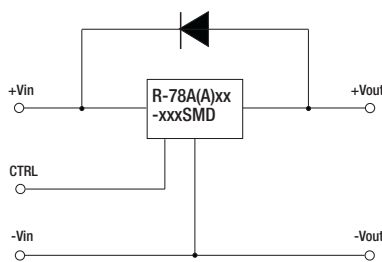

Optional Protection 2:

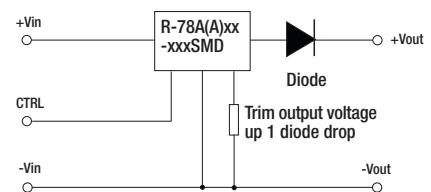

Application example:  
Driving a high capacitive load

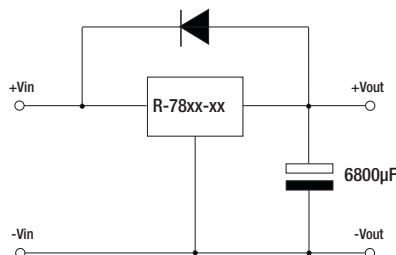

**Table 1: Adjustment Resistor Values**

1.0A <sub>dc</sub>	R-78A1.8-1.0SMD		R-78A2.5-1.0SMD		R-78A3.3-1.0SMD		R-78A5.0-1.0SMD	
V <sub>out</sub> (nom.)	1.8V <sub>dc</sub>		2.5V <sub>dc</sub>		3.3V <sub>dc</sub>		5.0V <sub>dc</sub>	
V <sub>out</sub> (adj)	R1	R2	R1	R2	R1	R2	R1	R2
1.5 (V)	3K $\Omega$		200 $\Omega$					
1.8 (V)			12K $\Omega$					
2.5 (V)		11.8K $\Omega$						
3.0 (V)		4.64K $\Omega$		44.2K $\Omega$	88.4K $\Omega$		17K $\Omega$	
3.3 (V)							27K $\Omega$	
3.6 (V)						60.4K $\Omega$	42K $\Omega$	
3.9 (V)						28K $\Omega$	58K $\Omega$	
4.5 (V)						11.3K $\Omega$	180K $\Omega$	
4.9 (V)						7.15K $\Omega$	850K $\Omega$	
5.0 (V)						6.34K $\Omega$		
5.1 (V)						5.9K $\Omega$		231K $\Omega$
5.5 (V)						3.9K $\Omega$		56.2K $\Omega$

**Package Style and Pinning (mm)**

R-78AA-1.0

**SMD 10Pin Package**

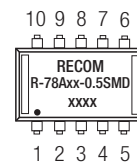
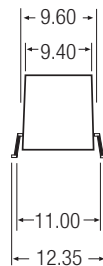
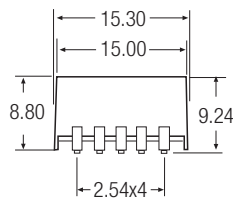

**Recommended Footprint Details**

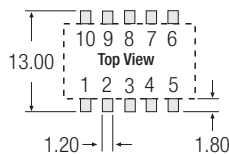
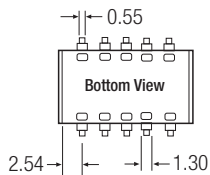

**Pin Connections**

Pin #	Connection
1,2	+Vin
3,7,8,9	GND
4,5	+Vout
6	V adj
10	Remote On/Off

xx.x  $\pm$ 0.5mm  
xx.xx  $\pm$ 0.25mm