

# WM20



## Power analyzer for three-phase systems



### Description

WM20 is a modular power analyzer for single-, two- and three-phase systems. It is made up of a maximum of three components: the main unit that displays measurements on the LCD display and manages two alarms, and two accessory modules, one with digital outputs and the other for communication. The digital output module associates alarms with static or relay outputs and/or transmits pulses proportional to energy consumption. The communication module allows you to configure the analyzer and transmit data using a different communication protocol according to the version.

### Applications

WM20 can be installed in any switchboard to control energy consumption, main electrical variables and harmonic distortion. In automation, WM20 can use the communication module with Profibus protocol to both communicate data on consumption to supervision systems and manage them independently if installed on a machine. In building, WM20 can be installed in existent architectures using the communication module with BACnet protocol (on RS485 or Ethernet).

### Benefits

- **Clarity.** The wide backlit LCD display clearly shows the measurements and the configuration parameter values.
- **Simplicity.** The rotating pages function automatically shows all measurements in sequence without having to use the keypad. An optical port is available for quick analyzer configuration using OptoProg (CARLO GAVAZZI).
- **Specific software.** WM20 can be configured and measurements viewed from UCS configuration software (CARLO GAVAZZI). The software and subsequent updates are free.
- **Scalability.** Two accessory modules can be added to WM20 according to need. This way, the analyzer extends its control capacities and communicates data remotely.
- **Communication flexibility.** The communication module is available in Modbus RTU, Modbus TCP/IP, BACnet IP, BACnet MS/TP and Profibus DP V0 versions.
- **Fast installation.** WM20 and accessory modules are all equipped with detachable terminals. Modules can be quickly installed via the specifically designed fast coupling pins.
- **Tamper-proof.** WM20 configuration access can be locked. Terminals and accessory modules can be sealed.

## Main functions

- Measure main electrical variables and voltage and current harmonic distortions
- Measure active and reactive energy
- Measure load operating hours
- Manage up to two alarms
- Manage two digital outputs (via optional accessory module)
- Transmit data to other systems (via optional accessory module)


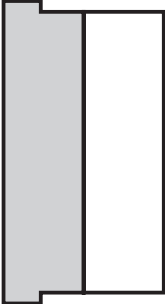
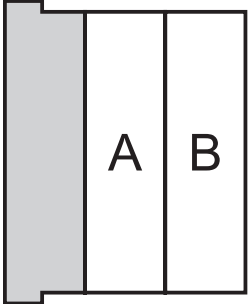
## Components

Module	Description
WM20	Main unit, measures and displays main electrical variables. With LCD display and touch keypad, it lets you set measurement parameters, configure accessory modules and manage up to two alarms.
Digital outputs (optional)	Accessory module with two digital outputs. Expands main unit capacity, specifically allowing you to: Transmit pulses proportional to energy consumption Control digital outputs (static or relay according to the module)
Communication (optional)	Accessory module that lets you transmit data to other systems or configure the analyzer from remote

## Compatible accessory modules

Type	Module description	Code
Digital outputs	Double static output	M O O2
	Double relay output	M O R2
Communication	Modbus RTU communication on RS485/RS232	M C 485232
	Modbus TCP/IP communication on Ethernet	M C ETH
	BACnet IP communication on Ethernet	M C BAC IP
	BACnet MS/TP communication on RS485	M C BAC MS
	Profibus DP V0 communication on RS485	M C PB

## Possible configurations

WM20 only	WM20 + 1 module	WM20 + 2 modules
		

**WARNING:** maximum 1 module per type. In the configuration with 2 modules, the communication module is installed last.

## Features

### General

<b>Material</b>	Front: ABS, self-extinguishing V-0 (UL 94) Back and accessory modules: PA66, self-extinguishing V-0 (UL 94)
<b>Protection grade</b>	Front: IP65 NEMA 4x NEMA 12 Terminals: IP20
<b>Terminals</b>	Type: detachable Section: 2.5 mm <sup>2</sup> maximum Torque: 0.5 Nm
<b>Overvoltage category</b>	Cat. III
<b>Pollution degree</b>	2
<b>Rejection (CMRR)</b>	100 dB, from 42 to 62 Hz
<b>Insulation</b>	double electrical insulation on areas accessible to the user. For insulation between inputs and outputs, see "Input and output insulation" on page 4.

### Input and output insulation

NOTE: test conditions: 4 kV rms ac for one minute.

Type	Power supply (H or L) [kV]	Measurement inputs [kV]	Digital outputs [kV]	Serial port [kV]	Ethernet port [kV]
Power supply (H or L)	-	4	4	4	4
Measurement inputs	4	-	4	4	4
Digital outputs	4	4	-	4	4
Serial port	4	4	4	-	NP
Ethernet port	4	4	4	NP	-

#### Key



- NP: combination not possible
- 4: 4 kV rms insulation (EN 61010-1, IEC 60664-1, overvoltage category III, pollution degree 2, double insulation on system with maximum 300 V rms grounding)

### Environmental

<b>Operating temperature</b>	From -25 to +55 °C/from -13 to +131 °F
<b>Storage temperature</b>	From -30 to +70 °C/from -22 to +158 °F

NOTE: R.H. < 90 % non-condensing @ 40 °C / 104 °F.

## Compatibility and conformity

<b>Directives</b>	2014/35/EU (Low Voltage) 2014/30/EU (Electro Magnetic Compatibility) 2011/65/EU (Electric-electronic equipment hazardous substances)
<b>Standards</b>	Electromagnetic compatibility (EMC) - emissions and immunity: EN62052-11 Electrical safety: EN61010-1 Metrology: EN62053-22, EN62053-22, EN50470-3 Pulse outputs: IEC62053-31, DIN43864
<b>Approvals</b>	 

# Main unit



## Main features

- System and phase variables (4 x 3 digits): V L-L, V L-N, A, W/var/VA, PF, Hz
- Active and reactive imported and exported energy meters (10 digits)
- Calculate the average and maximum system and phase power values
- Calculate current and voltage THD (total harmonic distortions) up to the 32<sup>nd</sup> harmonic
- Calculate load operating hours
- Rotating pages function
- Auxiliary power supply
- Two virtual alarms
- Backlit LCD display and touch keypad
- Optical port
- Detachable terminals
- Sealable terminal caps
- Configuration via keypad or UCS configuration software
- Filter to stabilize displayed measurements

## Description

Main unit with LCD display and touch keypad to view measurements, configure the system and manage two alarms.

It can be integrated by a digital output and communication module.

Four versions are available (AV4, AV5, AV6 and AV7) to manage different current and voltage inputs.

It can be quickly configured with OptoProg via optical port.

## Main functions

- Measure main electrical variables and harmonic voltage and current distortions
- Measure active and reactive energy
- Measure load operating hours
- Manage up to two alarms

## Structure

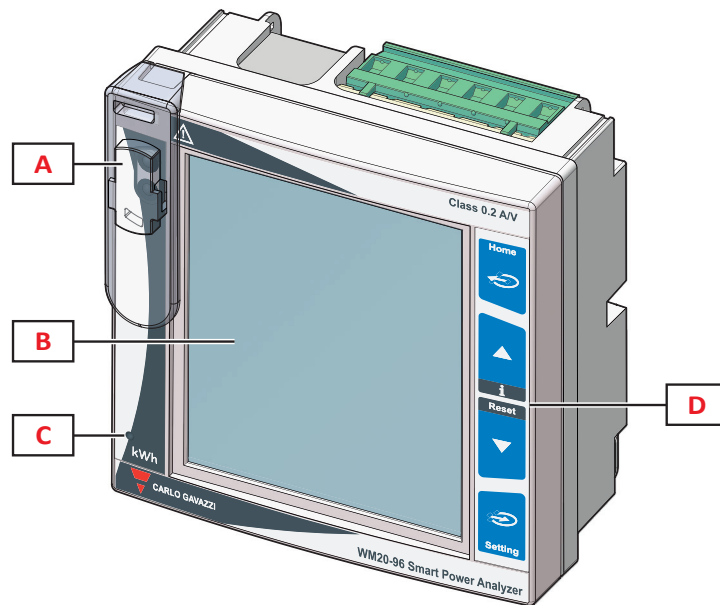


Fig. 1 Front

Element	Description
A	Optical port and plastic support for OptoProg (CARLO GAVAZZI) connection
B	Backlit LCD display
C	LED that blinks with frequency proportional to active energy consumption, see "LED" on page 11
D	Touch keypad

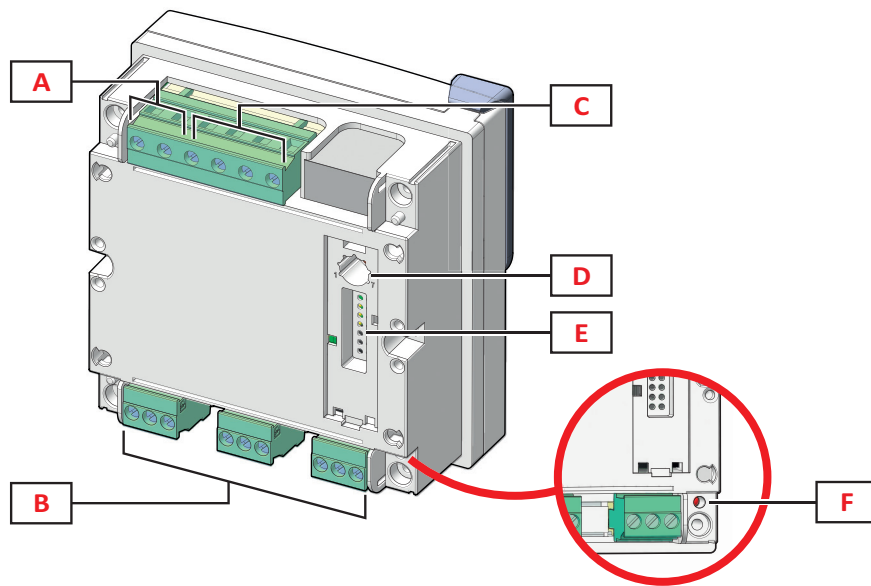


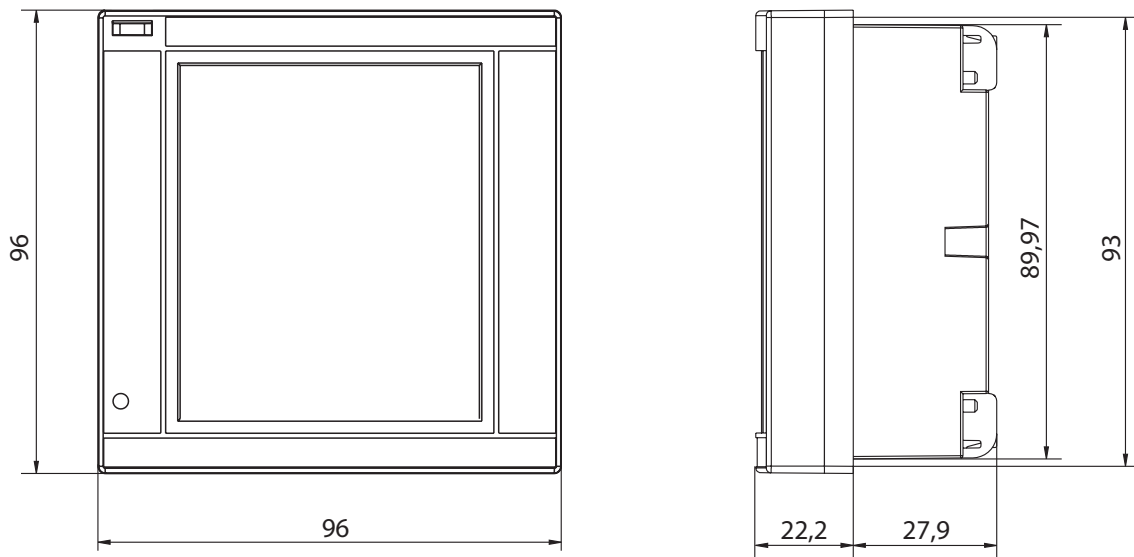
Fig. 2 Back

Element	Description
A	Detachable power supply terminals
B	Detachable current input terminals
C	Detachable voltage input terminals
D	Rotary selector to lock configuration
E	Local bus port for accessory modules
F	Power supply status LED, see "LED" on page 11

## Features

### General

<b>Assembly</b>	Panel mounting
<b>Weight</b>	420g



### Electrical specifications

Electrical system	
<b>Managed electrical system</b>	Single-phase (2-wire) Two-phase (3-wire) Three-phase with neutral (4-wire) Three-phase without neutral (3-wire)

Voltage				
Inputs	AV4	AV5	AV6	AV7
<b>Voltage connection</b>	Direct or via VT/PT			
<b>VT/PT transformation ratio</b>	From 1 to 9999			
<b>Rated voltage L-N (from Un min to Un max)</b>	From 220 to 400 V		From 57.7 to 133 V	
<b>Rated voltage L-L (from Un min to Un max)</b>	From 380 to 690 V		From 100 to 230 V	
<b>Voltage tolerance</b>	-20%, + 15%			
<b>Overload</b>	Continuous: 1.2 Un max For 500 ms: 2 Un max			
<b>Input impedance</b>	>1.6 MΩ			
<b>Frequency</b>	From 40 to 440 Hz			



Current				
Inputs	AV4	AV5	AV6	AV7
Current connection	Via CT			
CT transformation ratio	From 1 to 9999			
Rated current (I <sub>n</sub> )	1 A	5 A		1 A
Minimum current (I <sub>min</sub> )	0.01 A	0.05 A		0.01 A
Maximum current (I <sub>max</sub> )	2 A	6 A		2 A
Start-up current (I <sub>st</sub> )	1 mA	5 mA		1 mA
Overload	Continuous: I <sub>max</sub> For 500 ms: 20 I <sub>max</sub>			
Input impedance	< 0.2 VA			

### Power Supply

	H	L
Power Supply	From 100 to 240 V ac/dc ± 10%	From 24 to 48 V ac/dc ± 15%
Consumption	3.5 W, 6 VA	

### Measurements

Method	TRMS measurements of distorted waveforms
Sampling	3200 samples/s @50 Hz 3840 samples/s @60 Hz

### Available measurements

Active energy/Reactive energy	Total and partial. Imported Exported Note: partial meters can be viewed and reset via communication only.
Current	Neutral Phase System
Voltage	Phase-phase Phase-neutral System
Total harmonic distortion	Up to 32 <sup>nd</sup> harmonic. Current Phase-phase voltage Phase-neutral voltage
Active power/Apparent power/ Reactive power	Real-time, average and maximum values. Phase System
Power factor	Phase System
Frequency	System

NOTE: the available variables depend on the type of system set.

## Measurement accuracy

Current	
From 0.05 In to I <sub>max</sub>	$\pm(0.2\% \text{ rdg} + 2\text{dgt})$
From 0.01 In to 0.05 In	$\pm(0.5\% \text{ rdg} + 2\text{dgt})$

Phase-phase voltage	
From U <sub>n</sub> min -20% to U <sub>n</sub> max + 15%	$\pm(0.2\% \text{ rdg} + 1\text{dgt})$

Phase-neutral voltage	
From U <sub>n</sub> min -20% to U <sub>n</sub> max + 15%	$\pm(0.5\% \text{ rdg} + 1\text{dgt})$

Active and apparent power	
From 0.05 In to I <sub>max</sub> (PF=0.5L, 1, 0.8C)	$\pm(0.5\% \text{ rdg} + 1\text{dgt})$
From 0.01 In to 0.05 In (PF=1)	$\pm(1\% \text{ rdg} + 1\text{dgt})$

Reactive power	
From 0.1 In to I <sub>max</sub> (sin $\phi$ =0.5L, 0.5C)	$\pm(1\% \text{ rdg} + 1 \text{ dgt})$
From 0.05 In to I <sub>max</sub> (sin $\phi$ =1)	
From 0.05 In to 0.1 In (sin $\phi$ =0.5L, 0.5C)	$\pm(1.5\% \text{ rdg} + 1 \text{ dgt})$
From 0.02 In to 0.05 In (PF=1)	
Power factor	$\pm[0.001+0.5\%(1 - \text{PF rdg})]$
Active energy	Class 0.5S (EN62053-22), class 0.5 (ANSI C12.20)
Reactive energy	Class 2 (EN62053-23, ANSI C12.1)
THD	$\pm 1\%$

Frequency	
From 45 to 65 Hz	$\pm 0.1 \text{ Hz}$

## Display

Type	Backlit LCD
Refresh time	500 ms
Description	4 rows: 1 <sup>st</sup> : 10 digits (7.5 mm) 2 <sup>nd</sup> , 3 <sup>rd</sup> , 4 <sup>th</sup> : 4 digits (14 mm)
Variable readout	Instantaneous: 4 digits, min: 0.001, max: 9 999 Energy: 10 digits, min: 0.01, max: 9 999 999 999

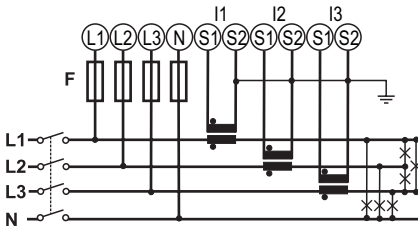
## LED

Front	Red. Weight: proportional to energy consumption and depending on the CT and VT/PT ratio product (16 Hz maximum frequency):	
	<b>Weight (kWh per pulse)</b>	<b>CT*VT/PT</b>
	0.001	< 7
	0.01	From 7.1 to 70
	0.1	From 70.1 to 700
	1	From 700.1 to 7000
	10	From 7001 to 70 k
	100	> 70.01 k
Back	Green. Power supply status.	

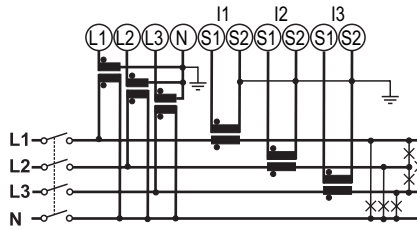
## Special functions

- Two virtual alarms (up or down alarm)
- Filter to stabilize variable measurements with high fluctuations
- Automatic measurement display sequence (rotating pages function)
- Load operating hour meter
- Total active and reactive energy meters and average and maximum values reset
- Optical port for configuration via OptoProg
- Password protected settings menu

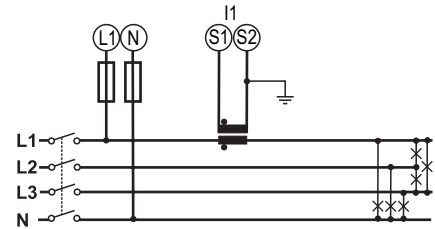
# Connection Diagrams



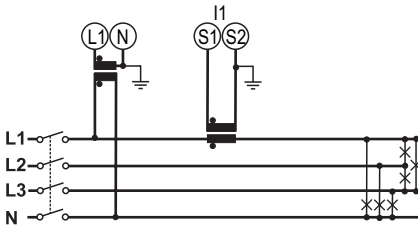
**Fig. 3** Three-phase system with neutral (4-wire), unbalanced load and 3 CT. 315 mA fuse (F).



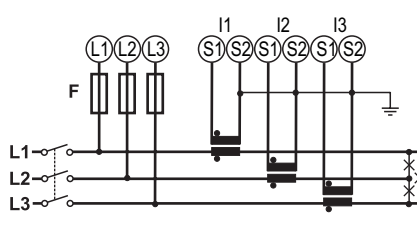
**Fig. 4** Three-phase system with neutral (4-wire), unbalanced load, 3 CT and 3 VT/PT



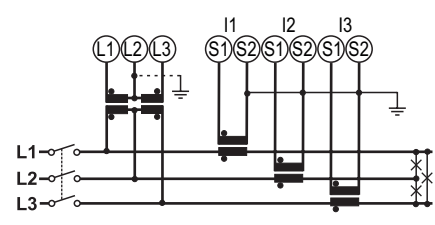
**Fig. 5** Three-phase system with neutral (4-wire), unbalanced load, 1 CT. 315 mA fuse (F).



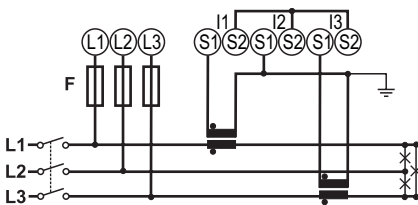
**Fig. 6** Three-phase system with neutral (4-wire), balanced load, 1 CT and 1 VT/PT



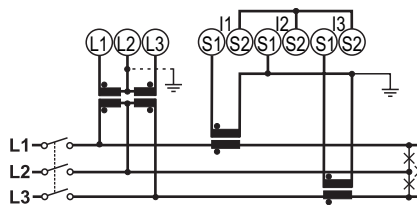
**Fig. 7** Three-phase system without neutral (3-wire), unbalanced load and 3 CT. 315 mA fuse (F).



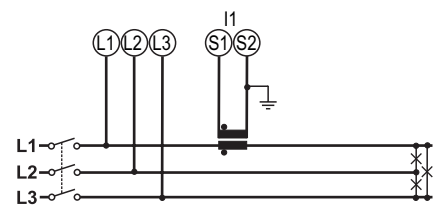
**Fig. 8** Three-phase system without neutral (3-wire), unbalanced load, 3 CT and 2 VT/PT.



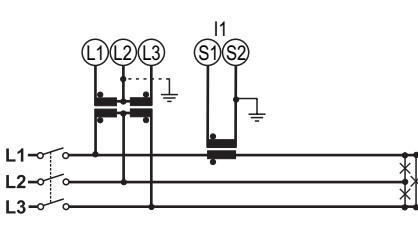
**Fig. 9** Three-phase system without neutral (3-wire) unbalanced load and 2 CT (Aron). 315 mA fuse (F).



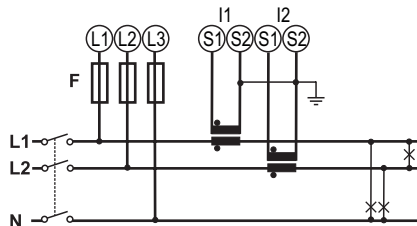
**Fig. 10** Three-phase system without neutral (3-wire), unbalanced load, 2 CT (Aron) and 2 VT/PT.



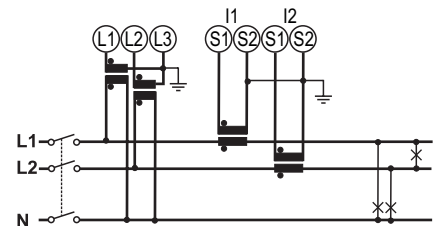
**Fig. 11** Three-phase system without neutral (3-wire), balanced load, 1 CT.



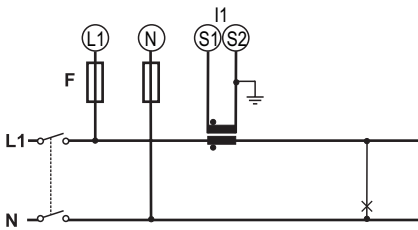
**Fig. 12** Three-phase system without neutral (3-wire), balanced load, 1 CT and 2 VT/PT.



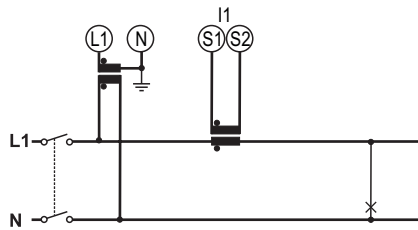
**Fig. 13** Two-phase system (3-wire), 2 CT. 315 mA fuse (F).



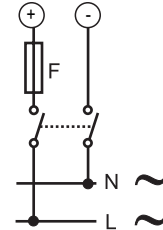
**Fig. 14** Two-phase system (3-wire), 2 CT and 2 VT/PT.



**Fig. 15** Single-phase system (2-wire), 1 CT. 315 mA fuse (F).



**Fig. 16** Single-phase system (2-wire), 1 CT and 1 VT/PT.



**Fig. 17** Auxiliary power supply (H). 250 V [T] 630 mA fuse (F).

## References

**Order code**

**WM20 AV**  **3**  (9 characters total)

Enter the code entering the corresponding option instead of

Code	Option	Description
W	-	-
M	-	-
2	-	-
0	-	-
A	-	-
V	-	-
<input type="checkbox"/>	4	From 380 to 690 V L-L ac, 1(2) A, connection via CT
	5	From 380 to 690 V L-L ac, 5(6) A, connection via CT
	6	From 100 to 230 V L-L ac, 5(6) A, connection via CT
	7	From 100 to 230 V L-L ac, 1(2) A, connection via CT
3	-	-
<input type="checkbox"/>	H	auxiliary power supply from 100 to 240 V ac/dc
	L	auxiliary power supply from 24 to 48 V ac/dc

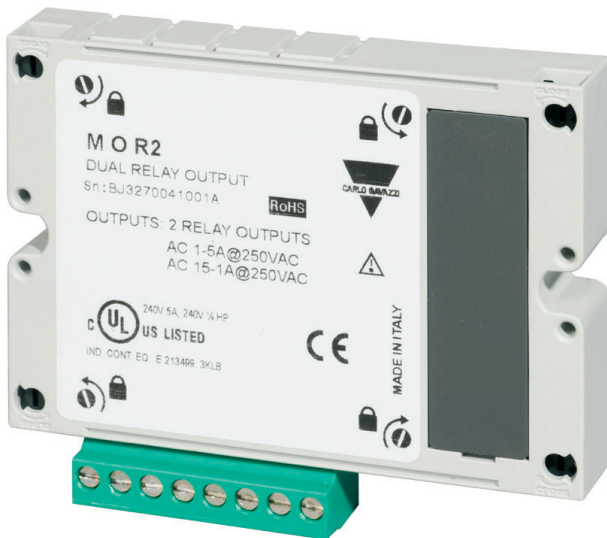
**Further reading**

Information	Where to find it
Instruction manual - WM20	<a href="http://www.productselection.net">www.productselection.net</a>


**CARLO GAVAZZI compatible components**

Purpose	Component name/code	Notes
Current measurement accessories	CTD1X, CTD2X, CTD3X, CTD4X	Solid core current transformers (1 or 5 A secondary current, 40 to 1600 A primary current) for cable or bus bar. See relevant data-sheets.
	CTD1Z, CTD2Z, CTD3Z	Solid core current transformers (5 A secondary current, 40 to 600 A primary current) for cable or bus bar. See relevant datasheets.
	CTD5S, CTD6S, CTD8S, CTD9S, CTD10S	Split core current transformers (5 A secondary current, 100 to 3200 A primary current) for bus bar. See relevant datasheets.
	CTD8V, CTD8V, CTD9V, CTD9H, CTD10V, CTD10H	Solid core current transformers (1 or 5 A secondary current, 150 to 3200 A primary current) for bus bar. See relevant datasheets.
	CTD8Q	Solid core current transformers (1 or 5 A secondary current, 1000 to 4000 A primary current) for bus bar. See relevant datasheets.
Manage two digital outputs/associate alarms to digital outputs	M O O2 M O R2	See "Digital output modules" on page 17
Transmit data remotely	M C 485232 M C ETH M C BAC IP M C BAC MS M C PB	See "Communication modules" on page 21
Configure analyzer via desktop application	UCS configuration software	Available for free download at: <a href="http://www.productselection.net">www.productselection.net</a>
Monitor data from several analyzers	VMU-C	See relevant datasheet
Quickly configure several analyzers via optical interface	OptoProg	See relevant datasheet
RS485/USB conversion	SIU-PC3	See relevant datasheet

# Digital output modules



## Description

Accessory module for WM analyzer family that associates static or relay outputs to alarms and/or transmits pulses proportional to energy consumption.

Each output can run three different functions: alarm, remote control or pulse.

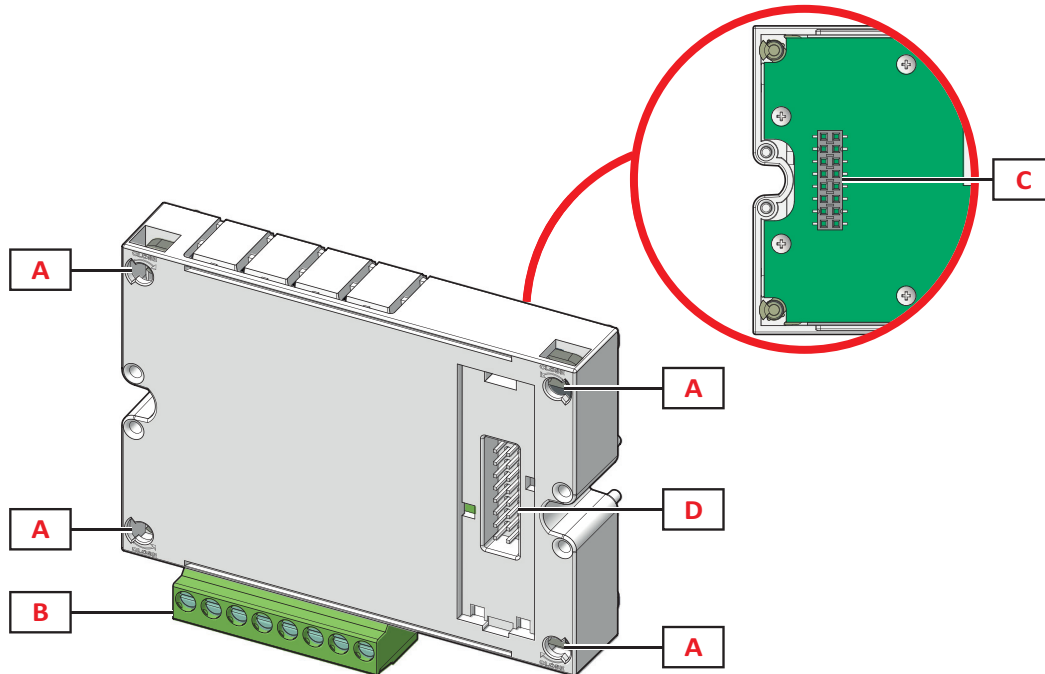
## Main features

- Two digital outputs (static or relay)
- Three possible functions for each output
- Configuration via main unit keypad or UCS configuration software
- Easy mounting on main unit
- Detachable terminals
- Local bus connection to main unit

## Main functions

- Manage two static or relay outputs
- Associate static or relay outputs with alarms
- Transmit pulses proportional to energy consumption

# Structure



Element	Description
A	Main unit fastening pins
B	Detachable digital output terminals
C	Local bus port for main unit
D	Local bus port for communication module

## ▶ Digital output functions

Digital outputs can run three different functions:

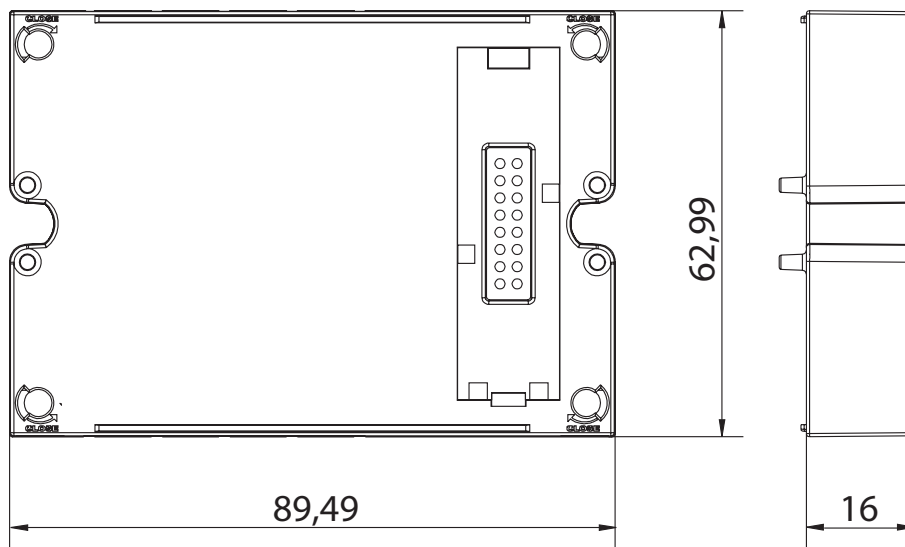
- Alarm: output associated with an alarm and directly managed by WM20
- Remote control: output status managed via communication
- Pulse: pulse transmission output on active or reactive, imported or exported energy consumption.



# Features

## General

<b>Assembly</b>	On main unit
<b>Weight</b>	80g
<b>Power supply</b>	Self power supply via local bus



## Static output module (M O O2)

<b>Maximum number of outputs</b>	2
<b>Type</b>	Opto-mosfet
<b>Features</b>	$V_{ON}$ : 2.5 V dc, 100 mA max $V_{OFF}$ : 42 V dc max
<b>Configuration parameters</b>	Output function: alarm/remote control/pulse Associated output alarm and normal status ("alarm" function only) Pulse weight, transmitted energy type, test transmission settings ("pulse" function only)
<b>Configuration mode</b>	Via keypad or UCS software

## Relay output module (M O R2)

<b>Maximum number of outputs</b>	2
<b>Type</b>	SPDT relay
<b>Features</b>	AC1: 5 A @ 250 V ac AC15: 1 A @250 V ac
<b>Configuration parameters</b>	Output function: alarm/remote control/pulse Associated output alarm and normal status ("alarm" function only) Pulse weight, transmitted energy type, test transmission settings ("pulse" function only)
<b>Configuration mode</b>	Via keypad or UCS software

## Connection Diagrams

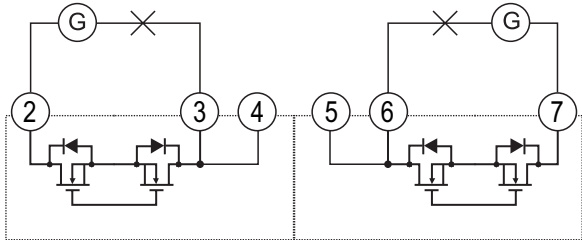


Fig. 18 M O O2. Double static opto-mosfet output.

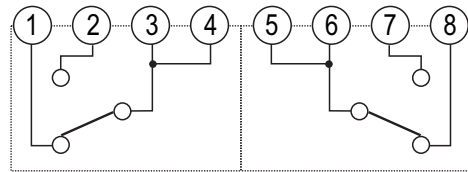


Fig. 19 M O R2. Double relay output.

## References

### Order code

Code	Description
M O O2	Double static output
M O R2	Double relay output

### Further reading

Information	Where to find it
Instruction manual - WM20	<a href="http://www.productselection.net">www.productselection.net</a>
Digital output module instruction manual	

### CARLO GAVAZZI compatible components

Purpose	Component name/code	Notes
Power the module via analyzer	WM20 WM30 WM40	The digital output module only works connected to an analyzer. See relevant datasheets.

# Communication modules



## Main features

- Supported communication protocols: Modbus, BACnet, Profibus. See "Communication module overview " on page 21
- Configuration via main unit keypad or UCS configuration software
- Easy mounting on main unit
- Local bus connection to main unit

## Main functions

- Transmit data remotely
- Configure the system

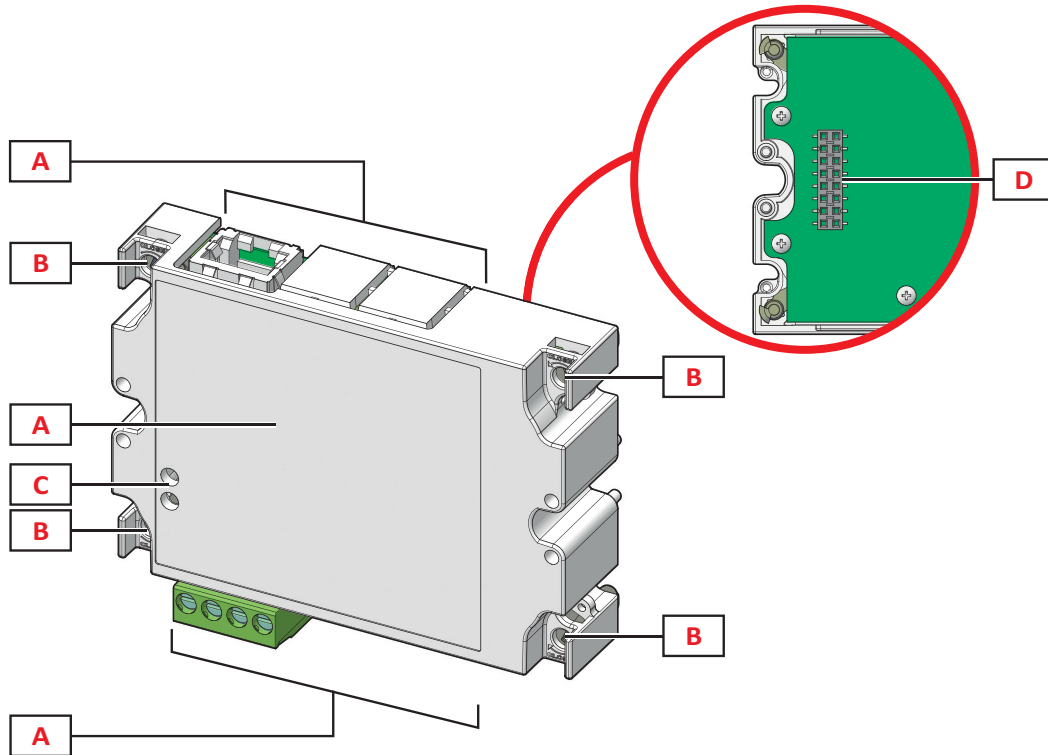
## Description

Accessory module for WM analyzer family connected to the main unit that transmits system data remotely using a different communication protocol according to the version.

## Communication module overview

Module code	Communication protocols	Port
M C 485232	Modbus RTU	RS485, RS232
M C ETH	Modbus TCP/IP	Ethernet
M C BAC IP	BACnet IP, Modbus TCP/IP	Ethernet
M C BAC MS	BACnet MS/TP	RS485
	Modbus TCP/IP	Ethernet
M C PB	Profibus DP V0 slave	RS485
	Modbus RTU	Micro-USB

## Structure



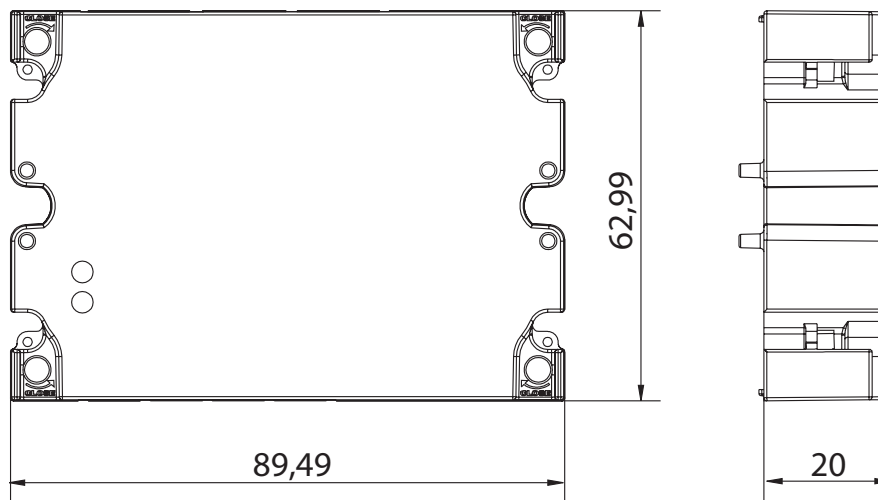
NOTE: the image refers to the M C BAC MS module.

Element	Description
A	Communication port area NOTE: the communication ports depend on the communication module, see "Communication module overview" on page 21.
B	Main unit fastening pins
C	Communication status LED (M C 485232, M C BAC MS, M C PB)
D	Local bus port for main unit or digital output module

# Features

**General**

<b>Assembly</b>	On main unit (with or without digital output module)
<b>Weight</b>	80g
<b>Power supply</b>	Self power supply via local bus



**M C 485232 module**

<b>RS485 port</b>	
<b>Protocols</b>	Modbus RTU
<b>Devices on the same bus</b>	Max 160 (1/5 unit load)
<b>Communication type</b>	Multidrop, bidirectional
<b>Connection type</b>	2 wires, maximum distance 1000 m
<b>Configuration parameters</b>	Modbus address (from 1 to 247) Baud rate (9,6/ 19,2/ 38,4/ 115,2 kbps) Parity (None/ Odd/ Even)
<b>Configuration mode</b>	Via keypad or UCS software

<b>RS232 port</b>	
<b>Protocols</b>	Modbus RTU
<b>Communication type</b>	Bidirectional
<b>Connection type</b>	3 wires, maximum distance 15 m
<b>Configuration parameters</b>	Modbus address (from 1 to 247) Baud rate (9,6/ 19,2/ 38,4/ 115,2 kbps) Parity (None/ Odd/ Even)
<b>Configuration mode</b>	Via keypad or UCS software

NOTE: the RS485 and RS232 ports are alternative.



LED	
Meaning	Communication status: Yellow: receiving Green: transmitting

### ▶ M C ETH module

Ethernet port	
Protocols	Modbus TCP/IP
Client connections	Maximum 5 simultaneously
Connection type	RJ45 connector (10 Base-T, 100 Base-TX), maximum distance 100 m
Configuration parameters	IP address Subnet mask Gateway TCP/IP port
Configuration mode	Via keypad or UCS software

### ▶ M C BAC IP module

Ethernet port	
Protocols	BACnet IP (reading) Modbus TCP/IP (reading and configuration)
Client connections	(Modbus only) Maximum 5 simultaneously
Connection type	RJ45 connector (10 Base-T, 100 Base-TX), maximum distance 100 m
Configuration parameters	BACnet IP protocol: Instance number (from 0 to 9999 via keypad, from 0 to 4194302 via communication) Foreign Device enabling BBMD address UDP port WM20 time-to-live recording as Foreign Device on specified BBMD server Modbus TCP/IP protocol: IP address Subnet mask Gateway TCP/IP port
Configuration mode	Via keypad or UCS software

### M C BAC MS module

RS485 port	
Protocols	BACnet MS/TP (measurement reading and object description writing)
Communication type	Multidrop, monodirectional
Connection type	2 wires, maximum distance 1000 m
Supported services	"I-have", "I-am", "Who-has", "Who-is", "Read-property (multiple)"
Supported objects	Type 2 (analogue value including COV property), type 5 (binary value, for alarm transmission), type 8 (device)
Configuration parameters	BACnet IP protocol: Instance number (from 0 to 9999 via keypad, from 0 to 4194302 via communication) Baud rate (9,6/ 19,2/ 38,4/ 57,6/ 76,8 kbps) MAC address (from 0 to 127)
Configuration mode	Via keypad or UCS software

Ethernet port	
Protocols	Modbus TCP/IP (configuration)
Client connections	(Modbus only) Maximum 5 simultaneously
Connection type	RJ45 connector (10 Base-T, 100 Base-TX), maximum distance 100 m
Configuration parameters	IP address Subnet mask Gateway TCP/IP port
Configuration mode	Via keypad or UCS software

LED	
Meaning	Communication status: Yellow: receiving Green: transmitting

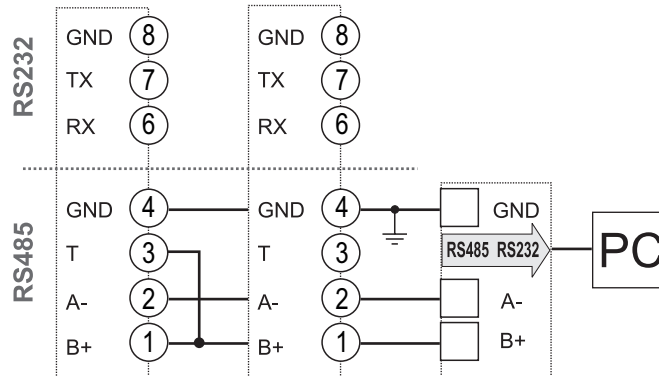
### M C PB module

Profibus port	
Protocols	Profibus DP V0 slave
Connection type	9-pin D-sub receptacle RS485
Configuration parameters	Address, via keypad Other settings with UCS software via serial communication
Configuration mode	Via keypad or UCS software

Micro-USB port	
Protocols	Modbus RTU
Type	USB 2.0 (USB 3.0 compatible)
Connection type	Micro-USB B
Baud rate	Any (maximum 115.2 kbps)
Address	1

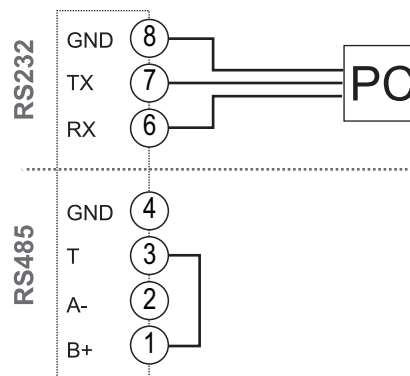
LED	
Meaning	Communication status: Red: between module and main unit Green: between module and Profibus master

# Connection Diagrams

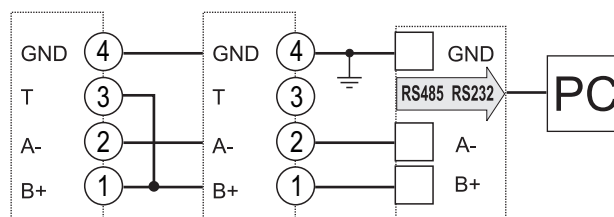


**Fig. 20** M C 485232. RS485 serial port.

NOTE: additional meters with RS485 are connected in daisy chain. The serial output must only be terminated on the last network meter connecting terminals B+ and T.



**Fig. 21** M C 485232. RS232 serial port.



**Fig. 22** M C BAC MS. RS485 serial port.

NOTE: additional meters with RS485 are connected in daisy chain. The serial output must only be terminated on the last network meter connecting terminals B+ and T.





## References

### Order code

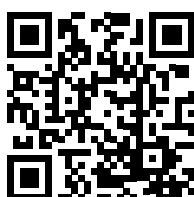
Code	Description
MC 485232	Modbus RTU communication on RS485/RS232
MC ETH	Modbus TCP/IP communication on Ethernet
MC BAC IP	BACnet IP communication on Ethernet
MC BAC MS	BACnet MS/TP communication on RS485
MC PB	Profibus DP V0 communication on RS485

### Further reading

Information	Where to find it
WM20 instruction manual	<a href="http://www.productselection.net">www.productselection.net</a>
Communication module instruction manual (M C 485232, M C ETH, M C BAC IP, M C BAC MS)	
Communication module instruction manual (M C PB)	

### CARLO GAVAZZI compatible components

Power the module via analyzer	WM20 WM30 WM40	The communication module only works connected to an analyzer. See relevant datasheets.
-------------------------------	----------------------	--



COPYRIGHT ©2016  
Content subject to change. Download the PDF: [www.productselection.net](http://www.productselection.net)