

WM15



Power analyzer for three-phase systems



Description

WM15 is a power analyzer for single-, two- and three-phase systems. Depending on the model, WM15 is equipped with a static output (pulse or alarm) or with a static output and a Modbus RTU communication port. The self-powered version can be installed on systems up to 415 V L-L, while the version with auxiliary power supply can be installed on systems up to 600 V L-L.

Applications

WM15 can be installed in any switchboard to control energy consumption, main electrical variables and harmonic distortion.

In panel boards, where typically three analogical ammeters are installed to give a visual feedback of the system status, WM15 provides the same information on the matrix display by means of the bar graphs.

When used to monitor a single machine, WM15 relates the energy consumption with the operating hours to schedule maintenance and detect faults. Moreover, the reset of partial counters allows to monitor each machine cycle.

Thanks to the MID certification, it can also be used for fiscal metrology.

Main functions

- Measure main electrical variables and voltage and current harmonic distortions
- Measure active and reactive energy
- Measure apparent energy
- Measure load operating hours

Benefits

- **Enhanced readability.** The backlit graphical display allows the size of the digits to be adapted to the displayed variable. The current values are also shown by a bar graph to have the plant situation at a glance.
- **Easy navigation.** The setup and navigation of the pages are very intuitive thanks to the user interface with 4 mechanical push buttons. In addition, the slideshow function automatically displays the desired measurements in sequence without having to use the keypad.
- **Quick setup.** Wizard and wiring check on first startup, UCS mobile app for setup via OptoProg and optical port are some of the advantages allowing a quick, guided and errorless installations and commissioning. UCS software is available for free download.
- **Fiscal metrology.** WM15 configuration access can be locked and terminals can be sealed in case of a MID certified model for fiscal metering.
- **Installation flexibility.** WM15 is suitable for single-phase, two-phase, three-phase and wild-leg systems with different voltage levels and grid frequencies used worldwide.

- Transmit data to other systems via Modbus RTU
- Manage a digital output for pulses or alarm transmission
- Visualize measured variables on display and current consumption via bar graph

Main features

- System and phase variables (V L-L, V L-N, A, W/var, VA, PF, Hz)
- Current and power (kW/kVA) demand calculation
- Simplified 4 push buttons user interface
- Optical port for easy configuration and diagnostic via OptoProg
- Digital output for pulse transmission or alarm
- Optional RS485 Modbus RTU (100 ms data refresh)
- Continuous sampling of each voltage and current
- Backlit matrix LCD display
- MID certified version
- cULus approved (UL 61010)

UCS software and UCS Mobile application

- Free download: UCS desktop from Carlo Gavazzi website, UCS Mobile from Google Play Store
- Configuration via OptoProg (via Bluetooth) or RS485 from PC (via UCS desktop) or Android mobile device (via UCS Mobile)
- Setups can be saved offline for serial programming with a single command
- Real time data view for testing and diagnostics
- Notification of possible wiring errors and display of the corrective steps, reassignment of the correct association of the phases or the direction of the currents via software control.

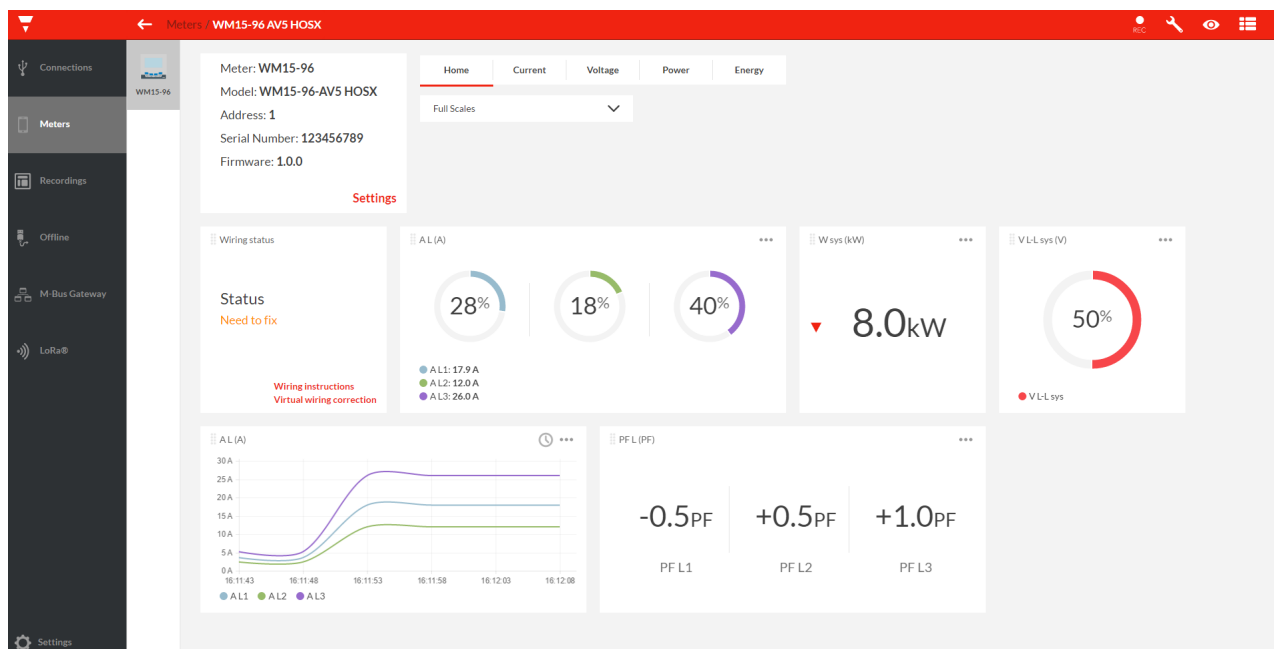

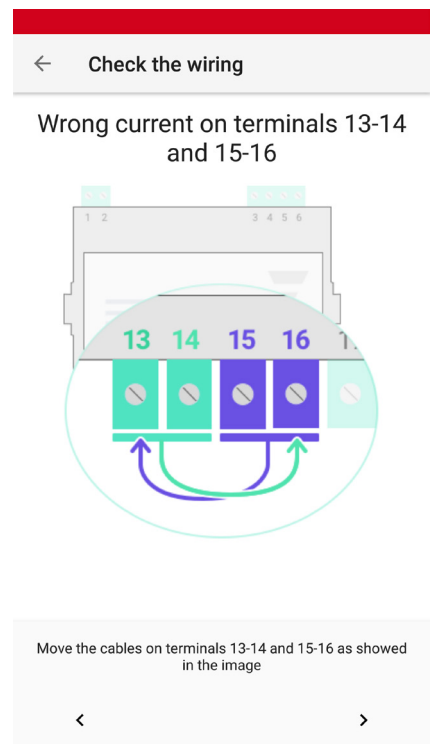
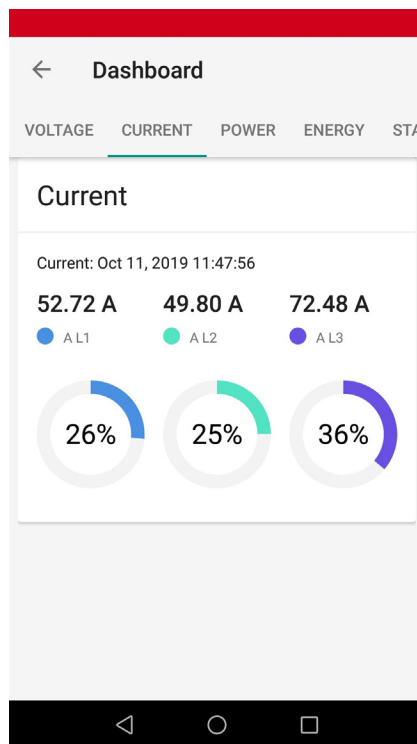
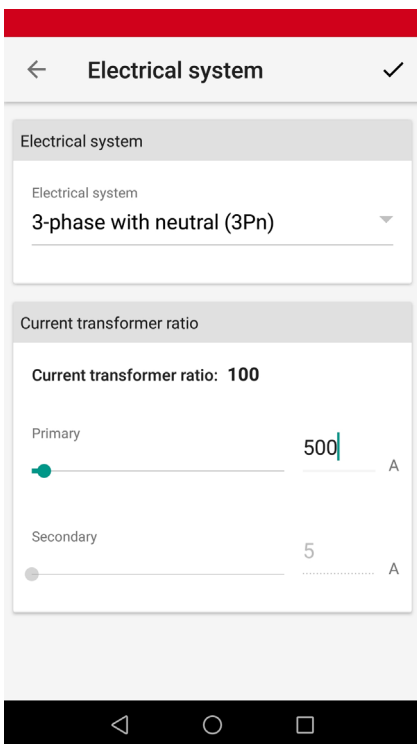
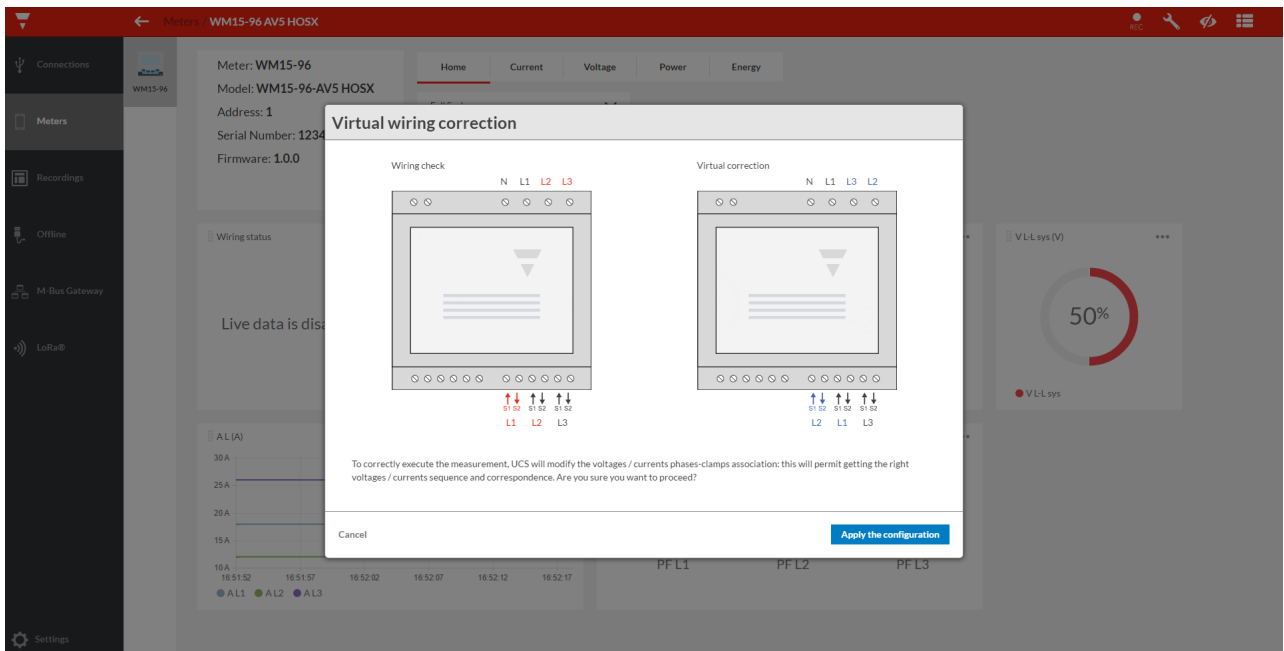

Structure

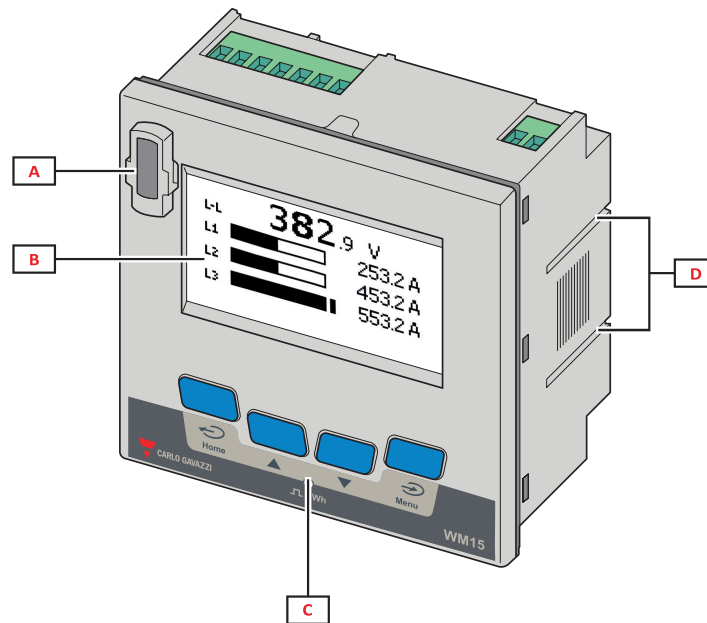

Fig. 1 Front

Area	Description
A	Optical port for easy programming and diagnostic via Optoprogram
B	Matrix LCD display
C	Mechanical push buttons
D	Grooves for lateral brackets

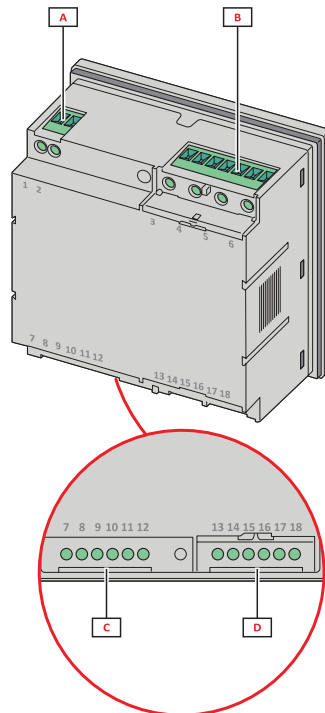

Fig. 2 Back

Area	Description
A	Power supply (auxiliary version)
B	3-phase voltage input
C	RS485 + digital output
D	3-phase current inputs

Features

General

Material	Housing: PC/ABS (UL94 V1) Transparent cover: PC (UL94 V2)
Protection degree	Front: IP51 Terminals: IP20
Terminals	Screw fixed terminal block, min:0.05; max: 2.5 mm ²
Overvoltage category	Cat. III
Pollution degree	2
Mounting	Panel 96 x 96
Weight	280 g

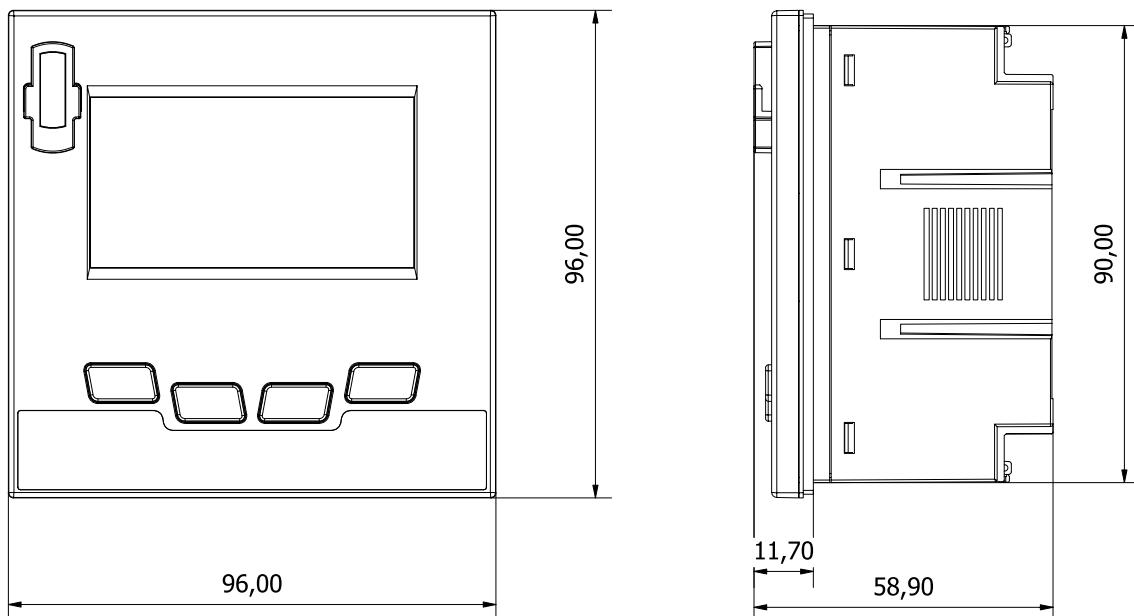

Environmental specifications

Operating temperature	From -25 to +55 °C/from -13 to +131 °F
Storage temperature	From -25 to +70 °C/from -13 to 158 °F



NOTE: R.H. < 90 % non-condensing @ 40 °C / 104 °F.

Input and output insulation

Type	Power supply (H) [kV]	Measurement inputs [kV]	Digital output [kV]	RS485 serial port [kV]
Power supply (H)	-	Base (AV5 3H)	Double/Reinforced	Double/Reinforced
Measurement inputs	Base (AV5 3H)	-	Double/Reinforced	Double/Reinforced
Digital output	Double/Reinforced	Double/Reinforced	-	Functional (100 V ac/dc)
RS485 serial port	Double/Reinforced	Double/Reinforced	Functional (100 V ac/dc)	-

According to: EN 61010-1, EN 50470-1 (MID). Overvoltage category III. Pollution degree 2.

Compatibility and conformity

Directives	2014/35/EU (LVT - Low Voltage) 2014/30/EU (EMC - Electro Magnetic Compatibility) 2011/65/EU (Electric-electronic equipment hazardous substances)
Standards	Electromagnetic compatibility (EMC) - emissions and immunity: EN 62052-11; EN 50470-1 (MID) Electrical safety: EN 61010-1, EN 50470-1 (MID) Metrology: EN62053-21, EN62053-23, IEC61557-12, EN 50470-3 (MID) Pulse output: IEC 62053-31
Approvals	  MID (optional)

Electrical specifications

Electrical system	
Managed electrical system	Single-phase (2-wire) Two-phase (3-wire) Three-phase with neutral (4-wire) Three-phase without neutral (3-wire) Wild leg system (three-phase, four-wire delta)
MID managed electrical system	Three-phase with neutral (4-wire) Three-phase without neutral (3-wire)

Voltage inputs Non MID models		
	AV5 3X	AV5 3H
Voltage connection	Direct	
Rated voltage L-N (from U_n min to U_n max)	120 to 240 V	120 to 347 V
Rated voltage L-L (from U_n min to U_n max)	208 to 415 V	208 to 600 V
Voltage tolerance	From 0.8 to 1.15 U_n	
Overload	Continuous: 1.5 U_n max	
Input impedance	Refer to "Power supply"	>1600 k Ω
Frequency	From 45 to 65 Hz	

Note: for MID versions the voltage range is limited to 3x230 (400) V, frequency to 50Hz.

Voltage inputs - MID	
Voltage connection	Direct
Rated voltage L-N	230 V
Rated voltage L-L	400 V
Voltage tolerance	From 0.8 to 1.15 Un
Overload	Continuous: 1.5 Un max
Input impedance	Refer to "Power supply"
Frequency	50 Hz

NOTE: in case of wild leg system (three-phase, four-wire delta) one of the line-to-neutral voltage can exceed the rated range in the table up to:

- 415 V (AV5 3H)
- 208 V (AV5 3X, AV5 3H).

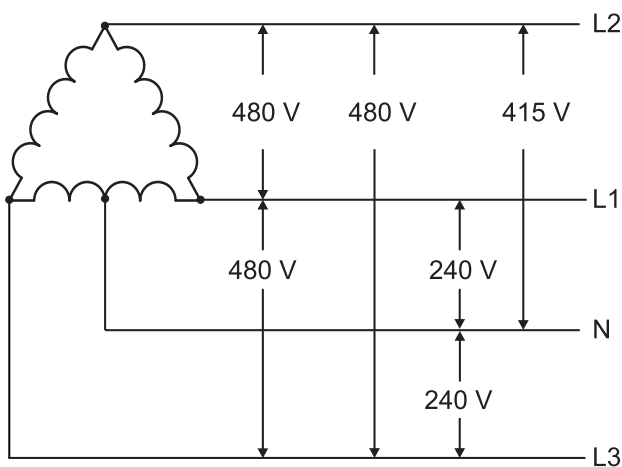

Fig. 3 AV5 3H

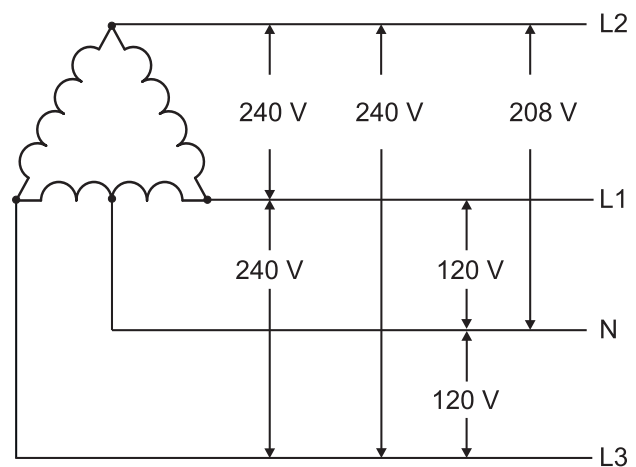

Fig. 4 AV5 3X, AV5 3H

Current inputs	
Current connection	Via CT
CT transformation ratio	2000 max
Rated current (In)	5 A
Minimum current (Imin)	0.05 A
Maximum current (Imax)	6 A
Start-up current (Ist)	10 mA
Overload	For 500 ms: 20 Imax (120 A)
Input impedance	< 0.2 VA
Crest factor	3

Power supply

	AV5 3X	AV5 3H
Type	Self power supply	From 120 to 240 V ac/dc
Frequency	50/60 Hz	

Measurements

Method	TRMS measurements of distorted waveforms
--------	--

Available measurements

Active energy	Unit	System	Phase
Imported (+) Total	kWh+	●	●
Imported (+) partial	kWh+	●	-
Exported (-) Total	kWh-	●	-
Exported (-) partial	kWh-	●	-

Reactive energy	Unit	System	Phase
Imported (+) Total	kvarh+	●	-
Imported (+) partial	kvarh+	●	-
Exported (-) Total	kvarh-	●	-
Exported (-) partial	kvarh-	●	-

Apparent energy	Unit	System	Phase
Total	kVAh	●	-
Partial	kVAh	●	-

Run hour meter	Unit	System	Phase
Total (kWh+)	hh:mm	●	-
Partial (kWh+)	hh:mm	●	-
Total (kWh-)	hh:mm -	●	-
Partial (kWh-)	hh:mm -	●	-

Electrical variable	Unit	System	Phase
Voltage L-N	V	●	●
Voltage L-L	V	●	●
Current	A	●	●
DMD	A	-	●
DMD MAX	A	-	●
Active power	W	●	●
DMD	W	●	-
DMD MAX	W	●	-
Apparent power	VA	●	●
DMD	VA	●	-
DMD MAX	VA	●	-
Reactive power	Var	●	●
Power factor	PF	●	●
Frequency	Hz	●	-
THD Current*	THD A %	-	●
THD Voltage L-N*	THD L-N %	-	●
THD Voltage L-L*	THD L-L %	-	●

NOTE: the available variables depend on the type of system set.

* Up to 15th harmonic

Energy metering

For every measuring interval time, the energies of the single phases are summed; according to the sign of the result, the positive (kWh+) or negative totalizer (kWh-) is increased.

Example:

P L1= +2 kW, P L2= +2 kW, P L3= -3 kW

Integration time = 1 hour

+kWh=(+2+2-3)x1h=(+1)x1h=1 kWh

-kWh=0 kWh

Measurement accuracy

Current	
From 0.1 In to I _{max}	± 0.5% rdg
From 0.01 In to 0.05 In	± 1% rdg
Phase-phase voltage	
From U _n min -20% to U _n max +15%	± 0.5% rdg
Phase-neutral voltage	
From U _n min -20% to U _n max +15%	± 0.5% rdg
Active and apparent power	
From 0.05 In to I _{max} (PF=0.5L, 1, 0.8C)	± 1% rdg
From 0.01 In to 0.05 In (PF=1)	± 1.5% rdg
Reactive power	
From 0.1 In to I _{max} (sinφ=0.5L,0.5C)	± 2% rdg
From 0.05 In to I _{max} (sinφ=1)	
From 0.05 In to 0.1 In (sinφ=0.5L,0.5C)	± 2.5% rdg
From 0.02 In to 0.05 In (PF=1)	
Active energy	Class 1 EN62053-21, Class B EN50470-3 (MID)
Reactive energy	Class 2 (EN62053-23)
Frequency	
From 45 to 65 Hz	± 0.1% rdg

Display

Type	Matrix 128x64 dots
Refresh time	500 ms
Description	Backlit LCD
Variable readout	Instantaneous: 5+1 dgt Power factor: 1+2 dgt Energy: 8+2 dgt

LED

Front	Red. Weight: proportional to energy consumption and depending on the CT ratio (16 Hz maximum frequency):	
	Weight (kWh per pulse)	CT
	0.001	≤ 7
	0.01	From 7.1 to 70
	0.1	From 70.1 to 700
	1	From 700.1 to 7000

Digital outputs

Digital output

Connection type	Screw terminals
Maximum number of outputs	1
Type	Opto-mosfet
Function	Pulse output or alarm output
Features	V_{ON} 2.5 V ac/dc, max 100 mA V_{OFF} 42 V ac/dc
Configuration parameters	Output function (pulse/alarm) Pulse weight (from 0.001 to 10 kWh per pulse) Pulse duration (30 or 100 ms) Output normal status (NO or NC)
Configuration mode	Via keypad or UCS software

Communication ports

RS485 port

Protocol	Modbus RTU
Devices on the same bus	Max 160 (1/5 unit load)
Communication type	Multidrop, bidirectional
Connection type	2 wires
Configuration parameters	Modbus address (from 1 to 247) Baud rate (9.6 / 19.2 / 38.4 / 115.2 kbps) Parity (None/ Odd/ Even)
Refresh time	≤ 100 ms
Configuration mode	Via keypad or UCS software

Optical port

Compatible accessories	OptoProg
Function	Configuration and diagnostic via UCS Mobile app or UCS software

Connection Diagrams

Non MID models

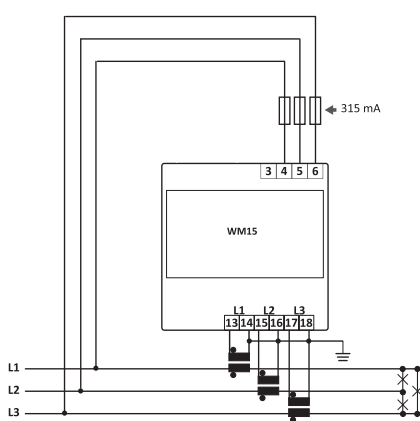

Fig. 5 Three-phase without neutral (3-wire)

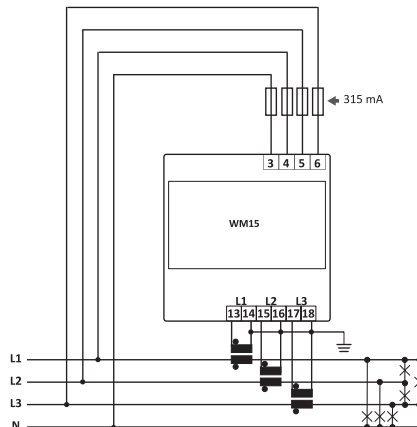

Fig. 6 Three-phase with neutral (4-wire)

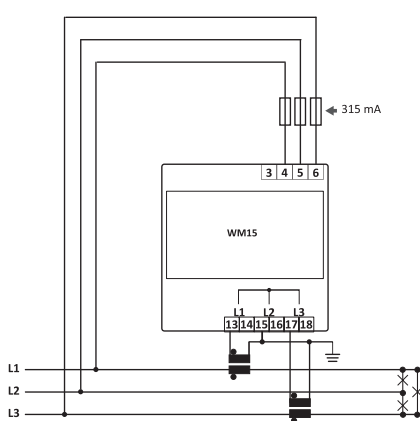

Fig. 7 Three-phase without neutral (3-wire)

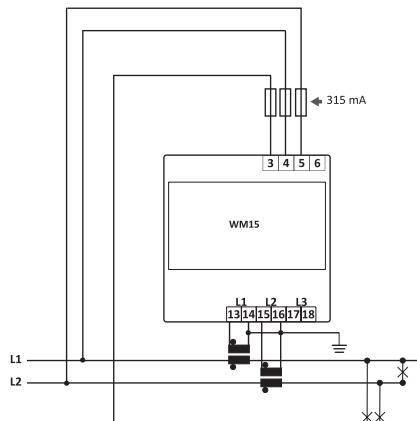

Fig. 8 Two-phase system with neutral (3-wire)

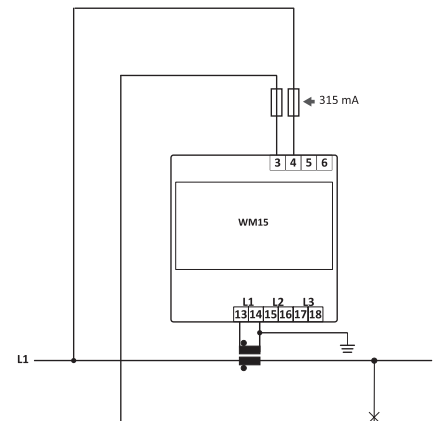

Fig. 9 Single-phase (2-wire)

MID models

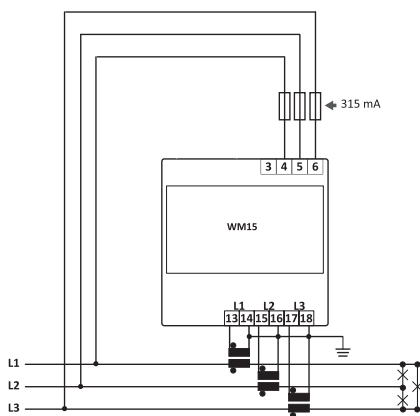

Fig. 10 Three-phase without neutral (3-wire)

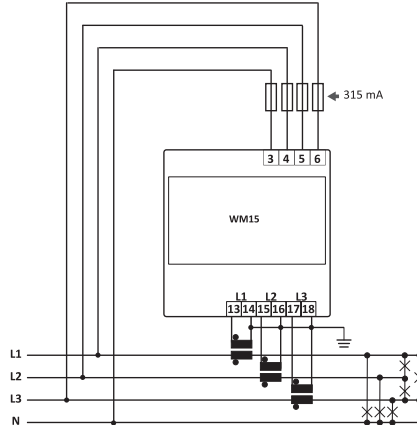

Fig. 11 Three-phase with neutral (4-wire)

Power supply

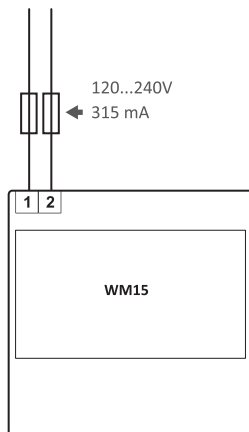

Fig. 12 Auxiliary power supply (H)

Output

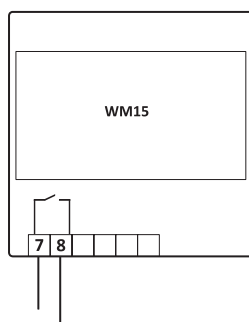

Fig. 13 Digital output

Communication

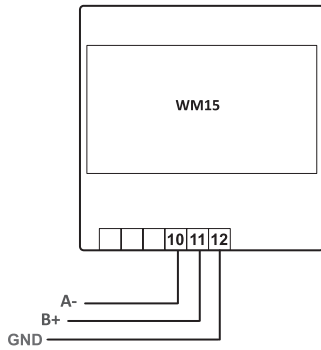

Fig. 14 RS485 port

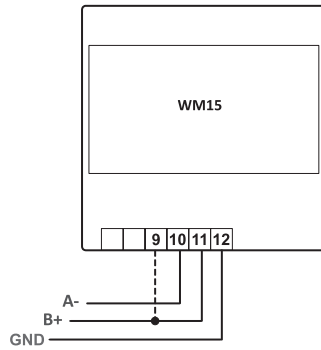

Fig. 15 Last device on RS485

References

Order code



WM15 96 AV5 3 X

Enter the code option instead of

Code	Options	Description
W	-	-
M	-	-
1	-	-
5	-	-
9	-	-
6	-	-
A	-	-
V	-	-
5	-	-
3	-	-
X	-	Self power supply. For systems up to 415 V LL
<input type="checkbox"/>	OS	Digital output and RS485
	OX	Digital output only
<input type="checkbox"/>	X	Non MID
	PFB	MID (3P and 3P.n)

- PFB: only the total positive totalizer (kWh+) is certified according to MID. The negative energy totalizer is available but not certified according to MID.



WM15 96 AV5 3 H OS X

Code	Options	Description
W	-	-
M	-	-
1	-	-
5	-	-
9	-	-
6	-	-
A	-	-
V	-	-
5	-	-
3	-	-
H	-	Auxiliary power supply. For systems up to 600 V LL
OS	-	Digital output and RS485
X	-	Non MID

CARLO GAVAZZI compatible components

Purpose	Component name/part number	Notes
Quickly configure several analyzers via optical interface	OptoProg	See relevant datasheet
Configure analyzer via desktop application	UCS software	Available for free download at: www.productselection.net
Configure analyzer via Android application	UCS Mobile	Available for free download at: https://play.google.com/store
Aggregate, store and transmit data to other systems	UWP 3.0	See relevant datasheet

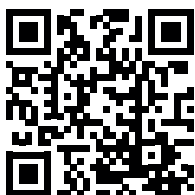

COPYRIGHT ©2019

Content subject to change. Download the PDF: www.productselection.net