

Semiconductor & Special Protection

Protistor® Square body fuse-links

Size 44 aR 500 to 750VAC 1200 to 5750A

Data Sheet

The PSR-LR Protistor® fuse-links is a high performance range designed to provide the best flexibility in equipment design and ultimate protection for today's power conversion equipment.

The Protistor® have been engineered to provide state-of-the-art protection for semiconductors: diodes, thyristors, GTO's and IGBT devices. Fuses are assembled with pure silver, die-cut elements embedded in solidified sand, which helps control arcing characteristics for a lower I^2t and high interrupting rating level. All contact surfaces are plated and all hardware is non-magnetic.

All fuse-links can be equipped with a low voltage trip-indicator which can operate a field mountable microswitch.



Benefits

- Ultra fast acting
- Highly Current limiting
- Very low I^2t for improved semiconductor protection
- Superior cycling capability
- aR Class according to VDE 636-23 and IEC 60269-4

Applications

Protection of inverters, UPS systems, motor drives and similar 750V or less equipment for standard 50/60Hz or specific low or high frequency applications.

Ratings

- 750V 1200 to 2400A
- 700V 2500 to 3000A
- 690V 3200 to 3500A
- 600V 3700 to 4200A
- 550V 4400 to 5000A
- 500V 5750A

Approvals

- UL/CSA Recognized Component
- AC: UL Guide No. E76491
- IEC 60269-4 Compliance
- RoHS Compliant



Related products

- Mounting accessories: Metric studs
- Monitoring: MC3E Microswitches

Packaging: 1 piece

Semiconductor & Special Protection

Protistor® Square body fuse-links

Size 44 aR 500 to 750VAC 1200 to 5750A



Size	Rated Voltage (V)	Nominal Current (A)	Class	Catalog Number TTQF	Reference Number	Catalog Number PPASF	Reference Number PPASF
44	750	1200	aR	PC44UD75V12CTQ**	N229207**	PC44UD75V12CP1	*
44	750	1350	aR	PC44UD75V13CTQ**	E228854**	PC44UD75V13CP1	*
44	750	1600	aR	PC44UD75V16CTQ**	E229084**	PC44UD75V16CP1	*
44	750	1800	aR	PC44UD75V18CTQ**	C229266**	PC44UD75V18CP1	*
44	750	2000	aR	PC44UD75V20CTQ**	Y229078**	PC44UD75V20CP1**	R236386**
44	750	2200	aR	PC44UD75V22CTQ**	K235184**	PC44UD75V22CP1	*
44	750	2400	aR	PC44UD75V24CTQ**	W233906**	PC44UD75C24CP1**	F233685**
44	700	2500	aR	PC44UD70V25CTQ*/**	*/**	PC44UD70V25CP1	*
44	700	2700	aR	PC44UD70V27CTQ**	E239158**	PC44UD70V27CP1	*
44	700	3000	aR	PC44UD70V30CTQ**	M302829**	PC44UD70V30CP1**	S302857**
44	690	3200	aR	PC44UD69V32CTQ	S221805	PC44UD70V32CP1	E226738
44	690	3500	aR	PC44UD69V35CTQ	P232888	PC44UD69V35CP4	W221808
44	600	3700	aR	PC44UD60V37CTQ*	*	PC44UD60V37CP1*	*
44	600	4000	aR	PC44UD60V40CTQ	T228867	PC44UD60V40CP1	*
44	600	4200	aR	PC44UD60V42CTQ	R233902	PC44UD60V42CP1	*
44	550	4400	aR	PC44UD55V44CTQ	R221873	PC44UD55V44CP1	*
44	550	4700	aR	PC44UD55V47CTQ*	*	PC44UD55V47CP1*	*
44	550	5000	aR	PC44UD55V50CTQ	S221874	PC44UD55V50CP1	*
44	550	5500	aR	PC44UD55V55CTQ	-	PC44UD55V55CP1	P229668
44	500	5750	aR	PC44UD50V57CTQ	T221875	PC44UD50V57CP1	*

Size	Rated Voltage (V)	Nominal Current (A)	Breaking Capacity @ Rated Voltage (kA)	Pre-arcing I ² t (A ² s)	Clearing I ² t @ Rated Voltage (A ² s)	Watts Loss @ 100% In (W)
44	750	1200	215	109600	610000	285
44	750	1350	215	157900	890000	295
44	750	1600	215	289700	1600000	320
44	750	1800	215	417300	2320000	342
44	750	2000	215	580600	3250000	350
44	750	2200	215	741700	4100000	380
44	750	2400	215	987800	5500000	395
44	700	2500	200	1097000	5650000	405
44	700	2700	200	1348000	6900000	420
44	700	3000	200	1867000	9500000	440
44	690	3200	215	2221000	10500000	460
44	690	3500	215	3023000	14300000	480
44	600	3700	225	3472000	14200000	495
44	600	4000	225	4354000	18500000	510
44	600	4200	225	5000000	21200000	525
44	550	4400	227	6172000	24000000	540
44	550	4700	227	7525000	29000000	550
44	550	5000	227	9644000	37300000	570
44	550	5500	227	9644000	37300000	660
44	500	5750	230	13880000	49500000	650

*For availability please consult us

**Ratings UL Recognized at 700V

Semiconductor & Special Protection

Protistor® Square body fuse-links

Size 44 aR 500 to 750VAC 1200 to 5750A



Dimensions (mm)

TTQF

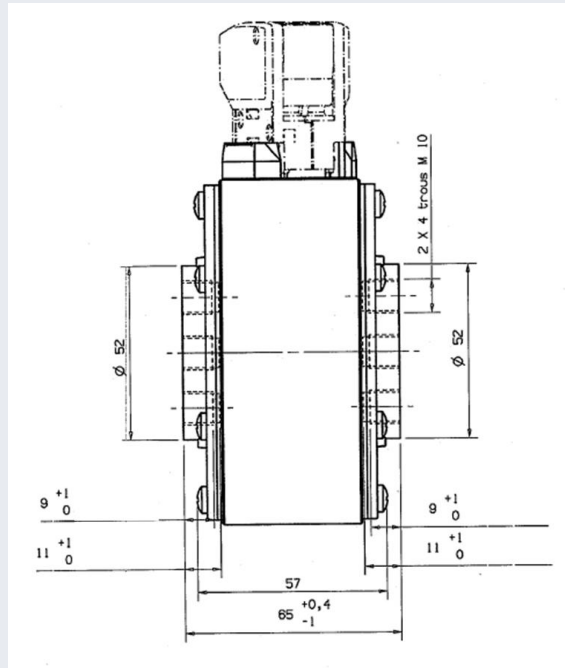
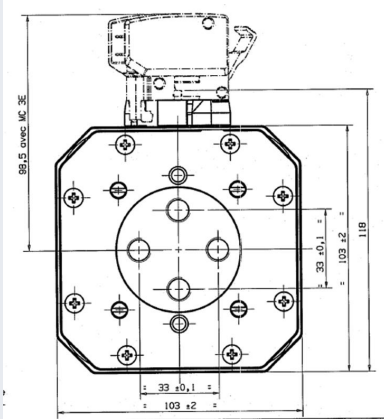

PPASF

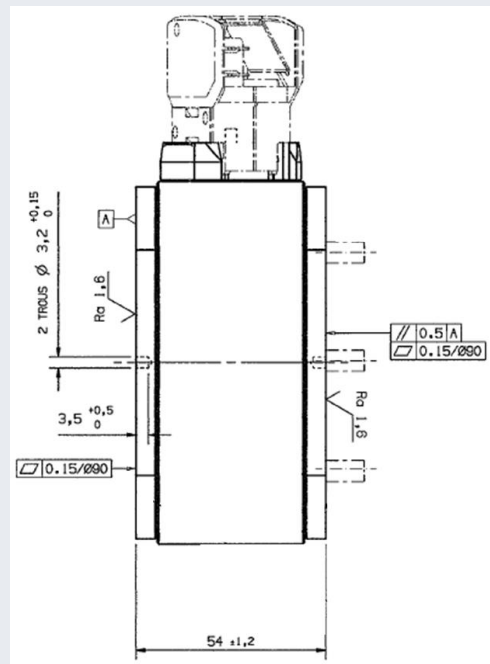
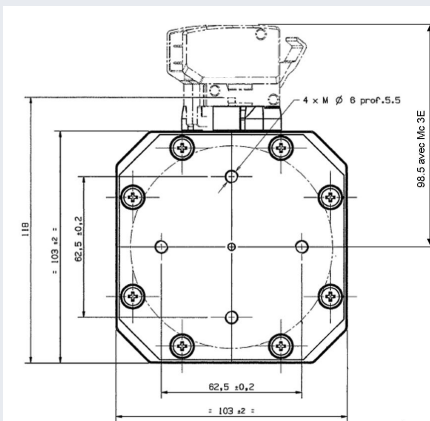

Semiconductor & Special Protection

Protistor® Square body fuse-links

Size 44 aR 500 to 750VAC 1200 to 5750A



Time current characteristics
750V 1200 to 2400A

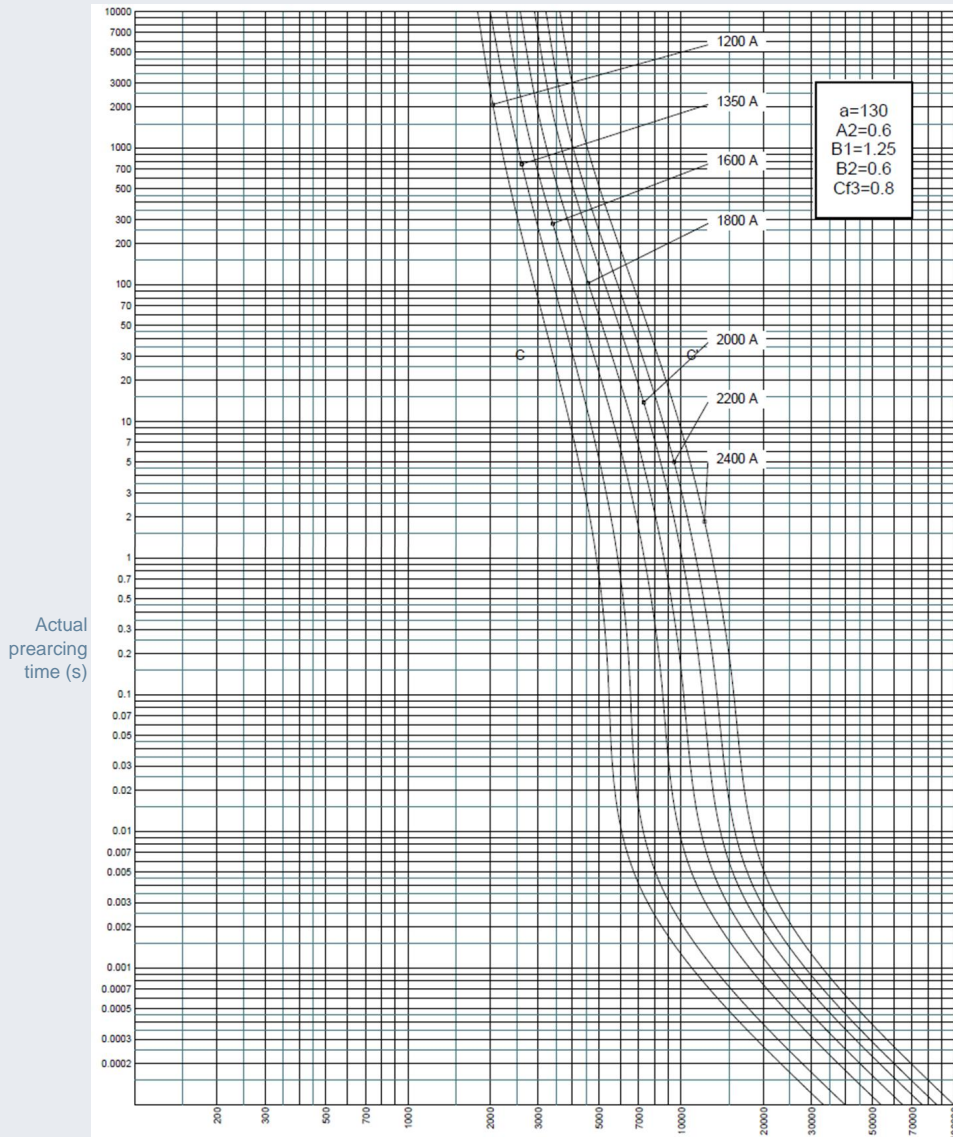

rms value of prearc current (A) ± 10%

Peak arc voltage
750V 1200 to 2400A

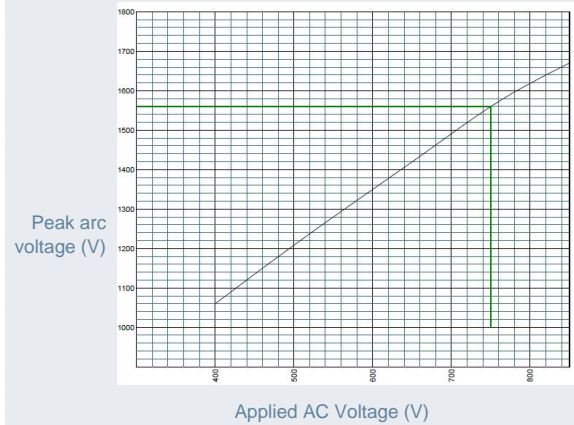

Semiconductor & Special Protection

Protistor® Square body fuse-links

Size 44 aR 500 to 750VAC 1200 to 5750A



I²t multiplier coefficient
750V 1200 to 2400A

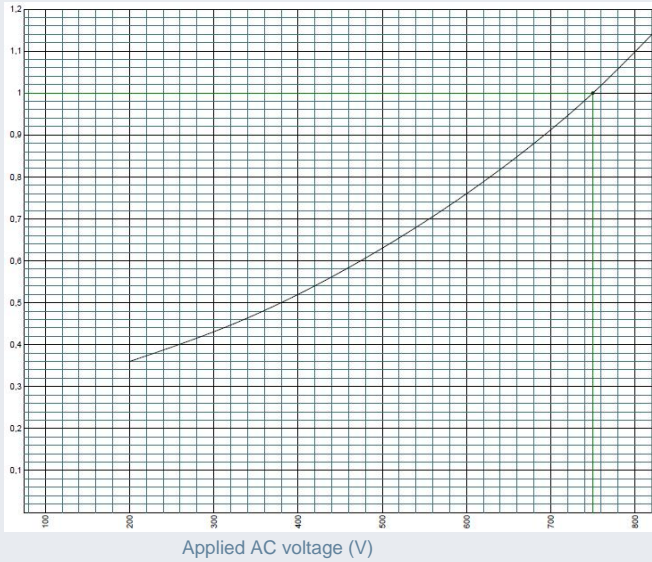

Clearing I²t and arcing time correction factor

Peak let thru characteristics
750V 1200 to 2400A

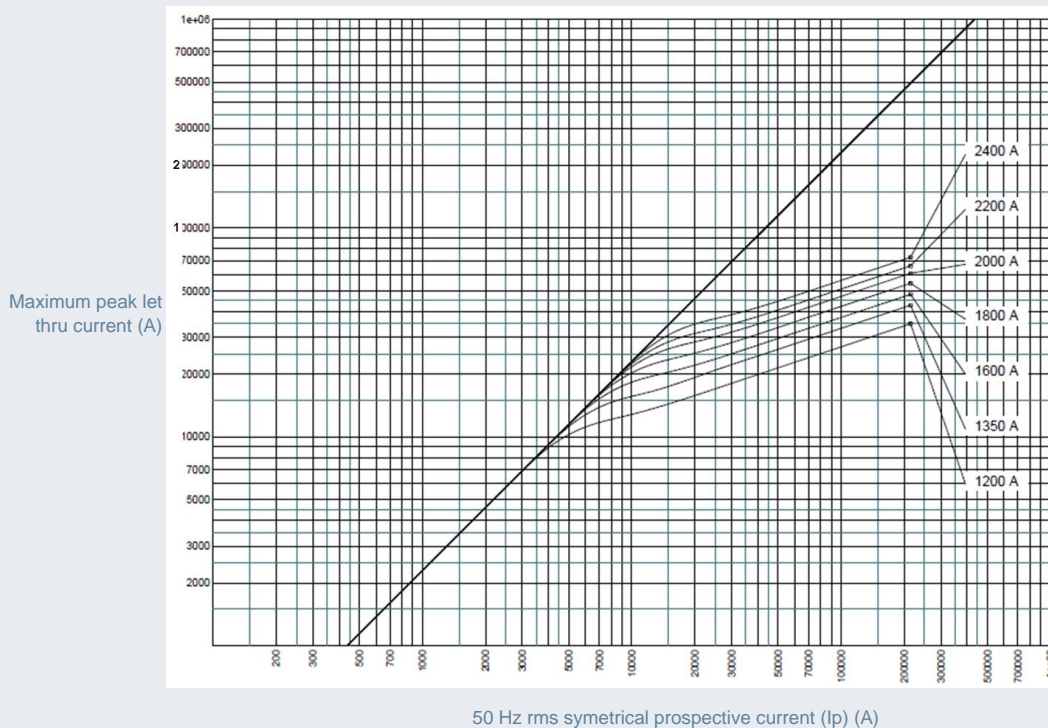

Semiconductor & Special Protection

Protistor® Square body fuse-links

Size 44 aR 500 to 750VAC 1200 to 5750A



Time current characteristics
700V 2500 to 3000A

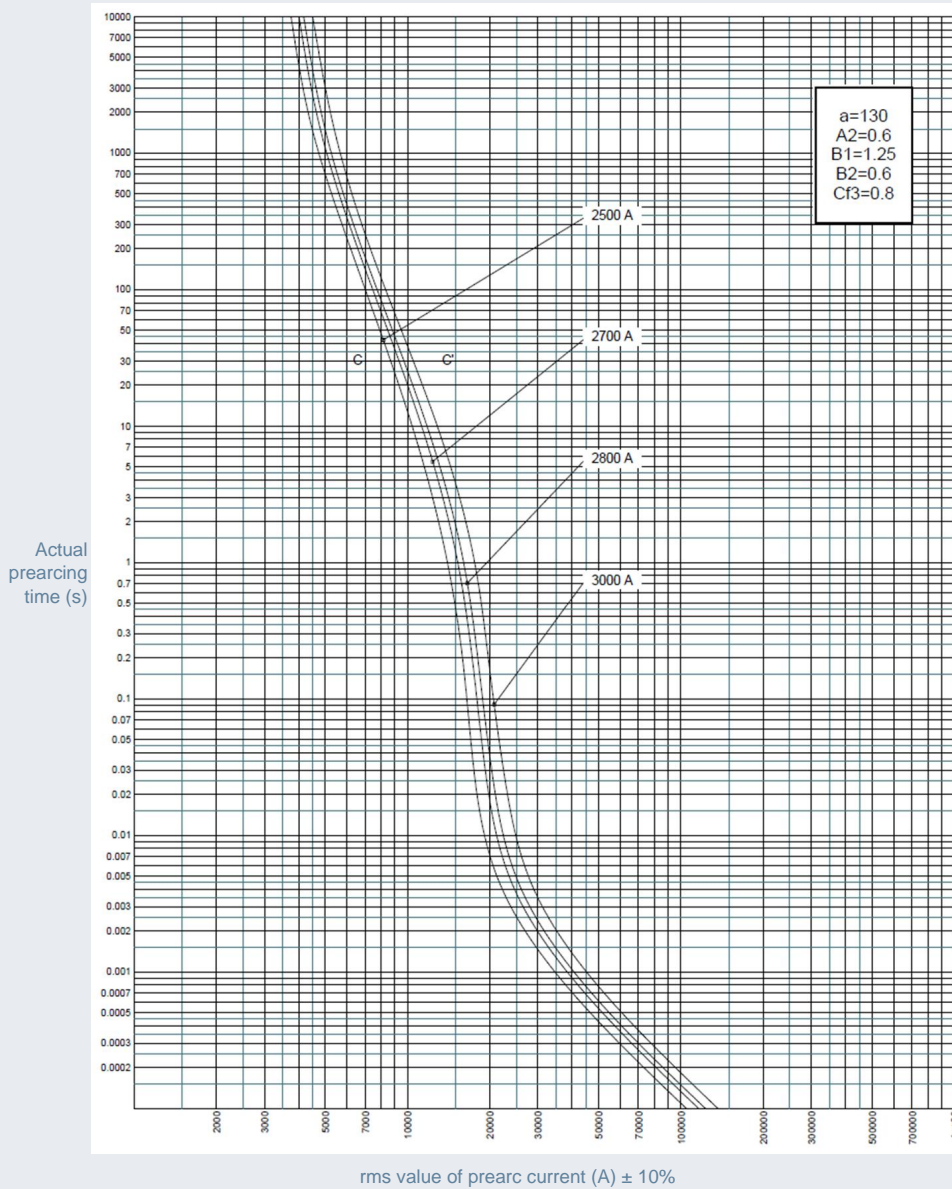

Peak arc voltage
700V 2500 to 3000A

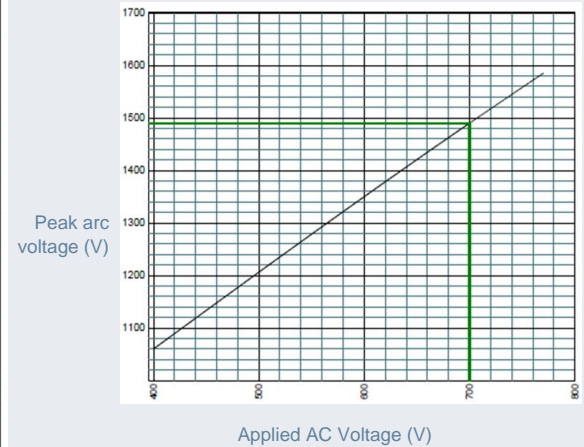

Semiconductor & Special Protection

Protistor® Square body fuse-links

Size 44 aR 500 to 750VAC 1200 to 5750A



I²t multiplier coefficient
700V 2500 to 3000A

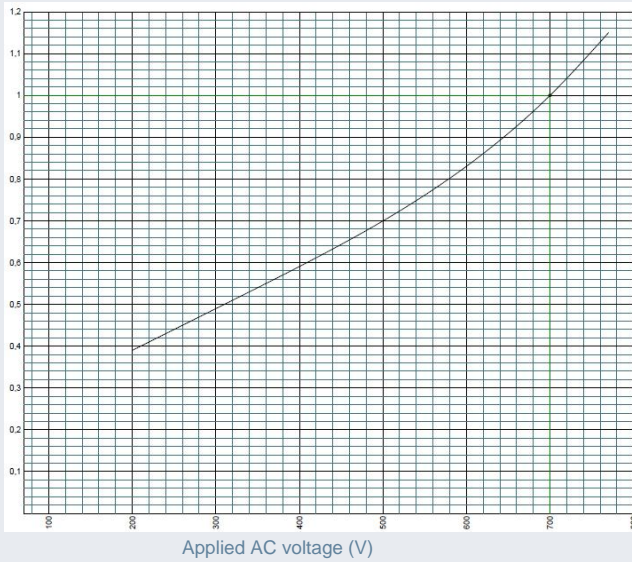

Clearing I²t and arcing time correction factor

Peak let thru characteristics
700V 2500 to 3000A

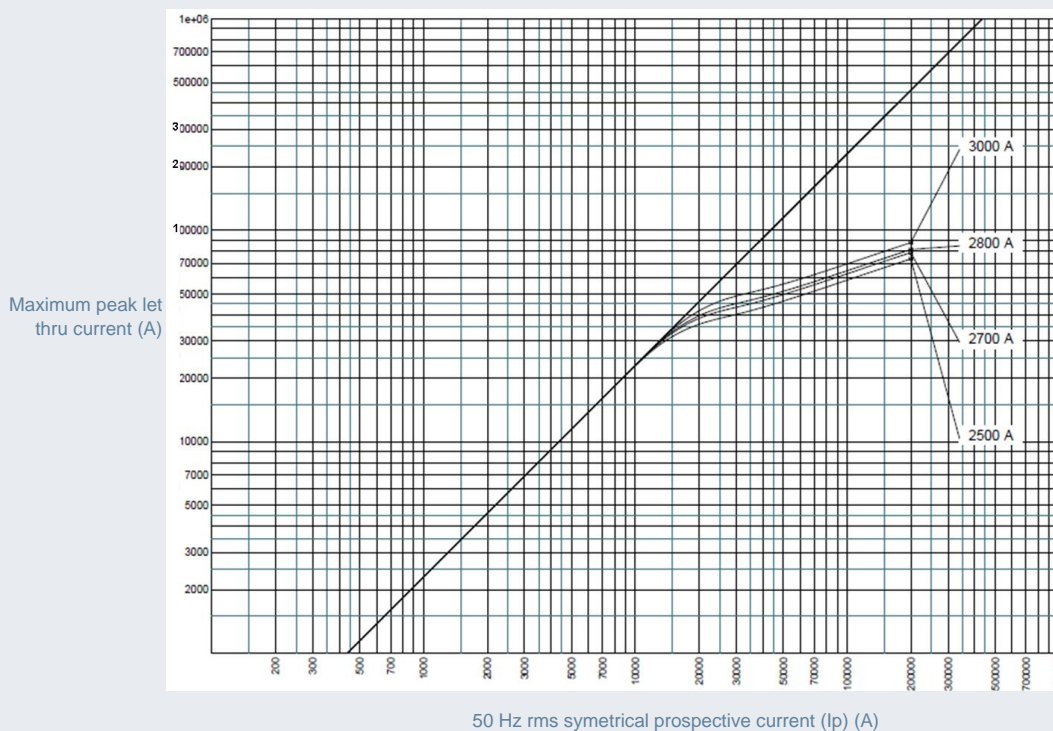

Semiconductor & Special Protection

Protistor® Square body fuse-links

Size 44 aR 500 to 750VAC 1200 to 5750A



Time current characteristics
690V 3200 to 3500A

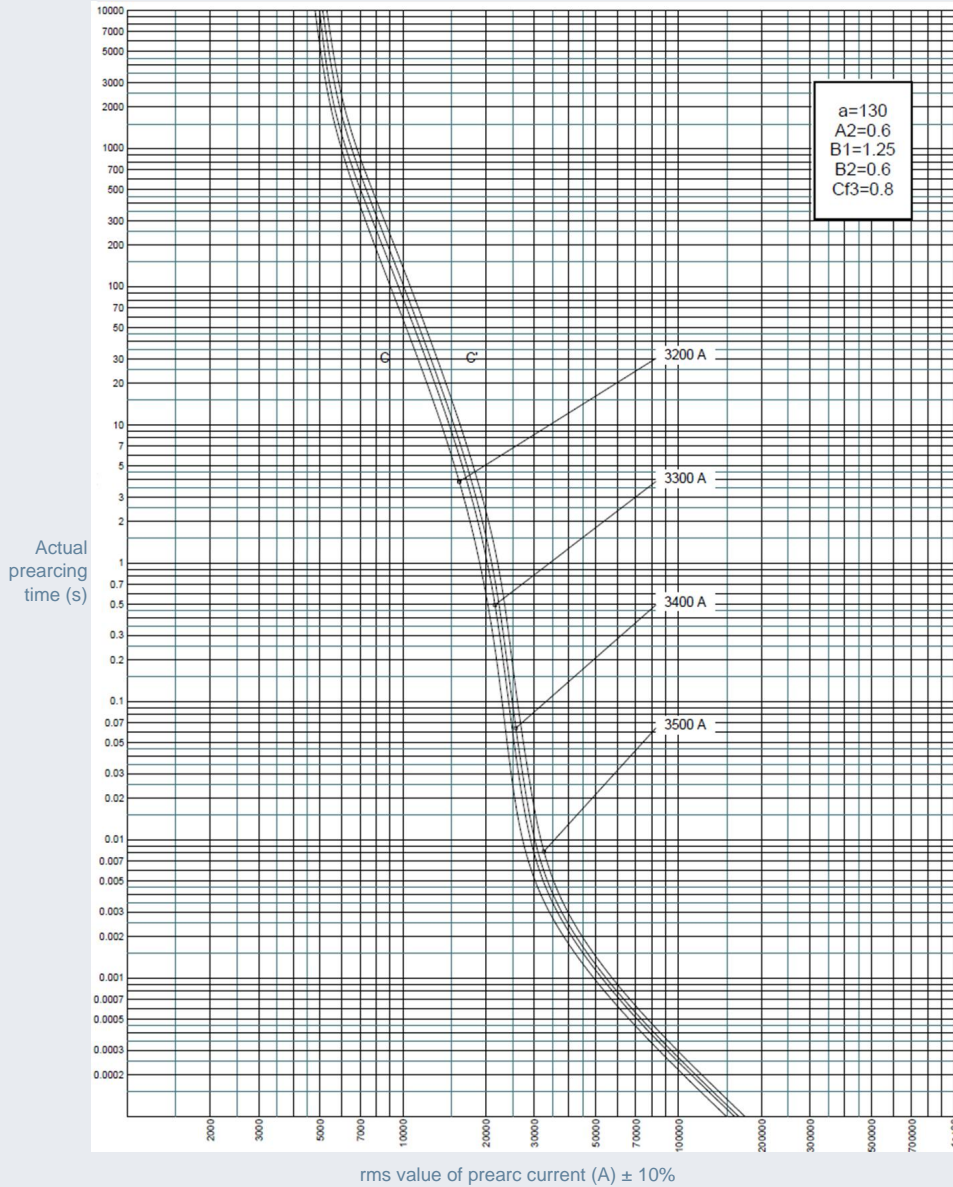

Peak arc voltage
690V 3200 to 3500A

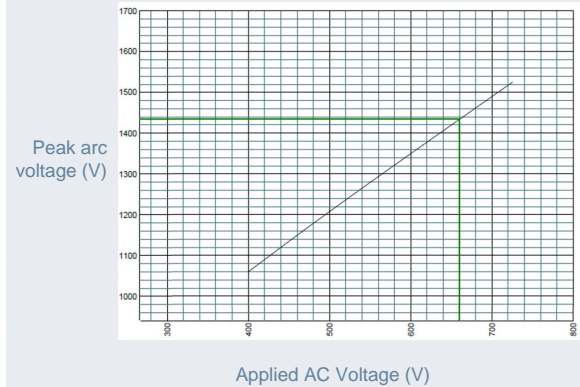

Semiconductor & Special Protection

Protistor® Square body fuse-links

Size 44 aR 500 to 750VAC 1200 to 5750A



I²t multiplier coefficient
690V 3200 to 3500A

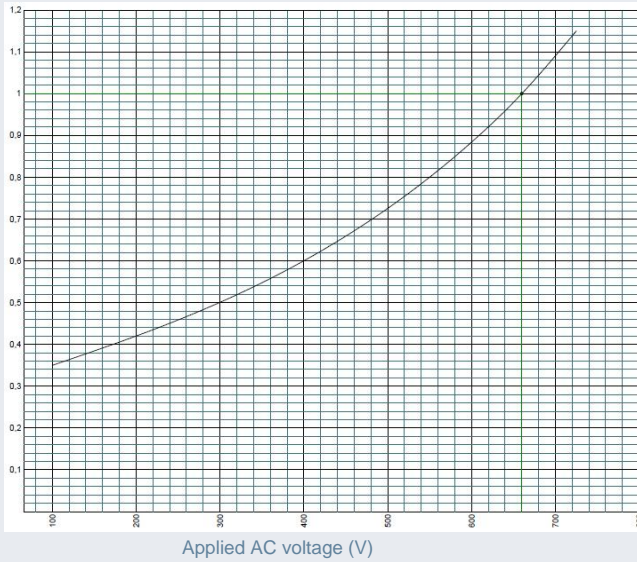

Clearing I²t and arcing time correction factor

Peak let thru characteristics
690V 3200 to 3500A

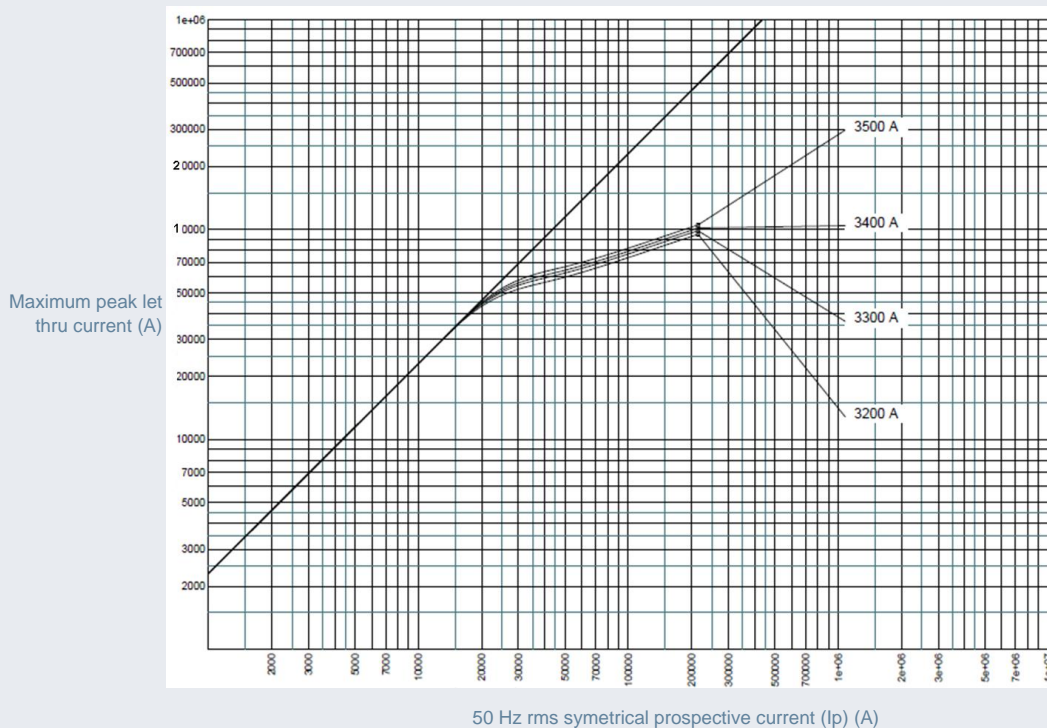

Semiconductor & Special Protection

Protistor® Square body fuse-links

Size 44 aR 500 to 750VAC 1200 to 5750A



Time current characteristics
600V 3600 to 4200A

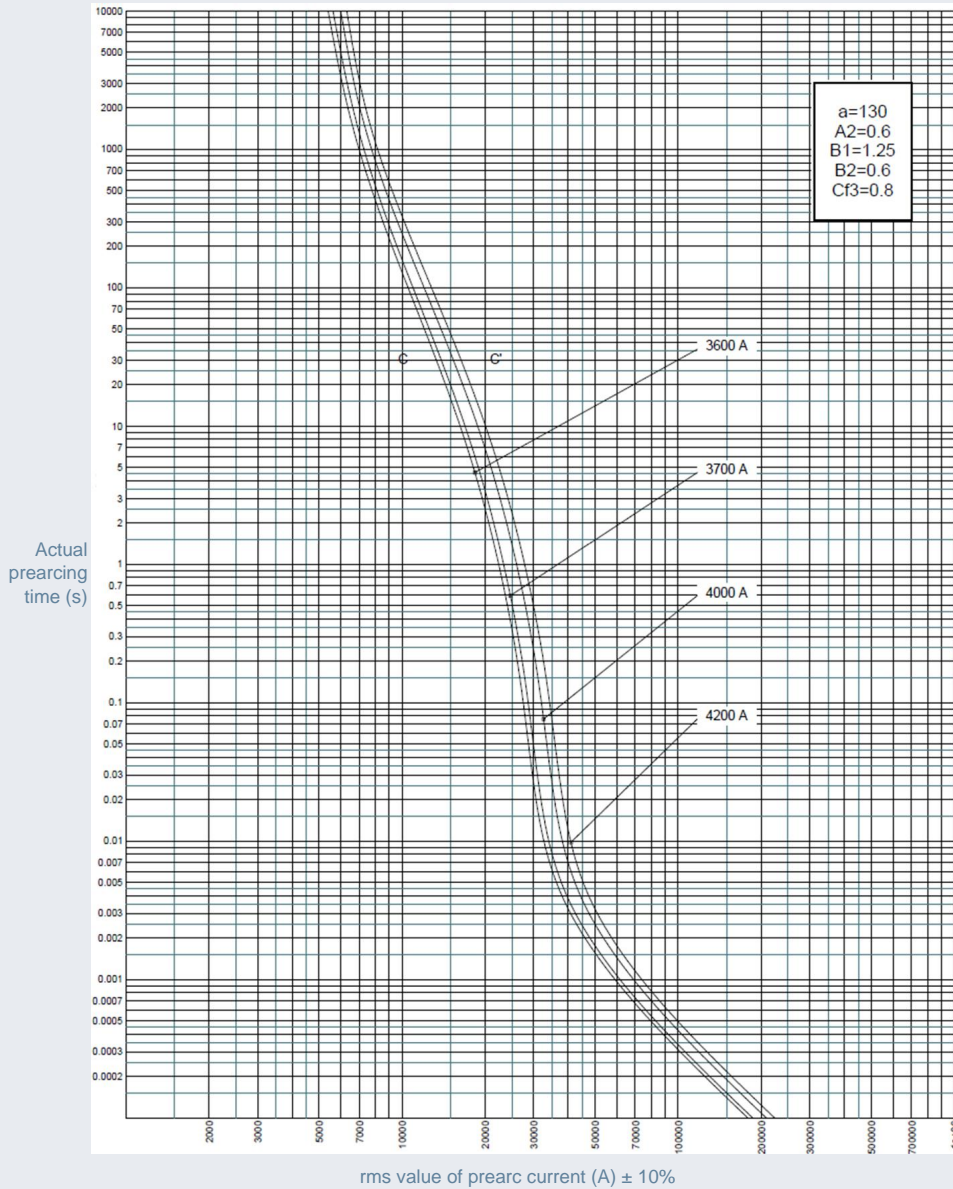

Peak arc voltage
600V 3600 to 4200A

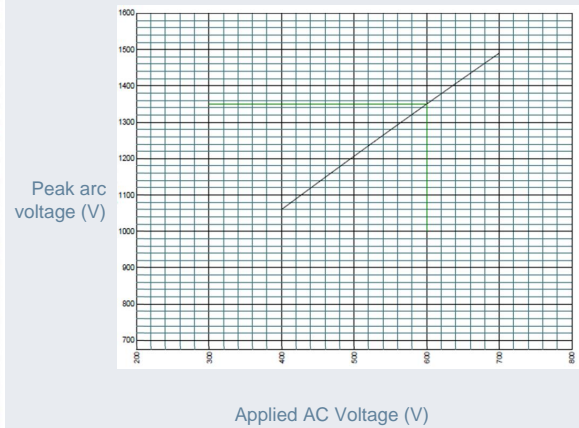

Semiconductor & Special Protection

Protistor® Square body fuse-links

Size 44 aR 500 to 750VAC 1200 to 5750A



I²t multiplier coefficient
600V 3600 to 4200A

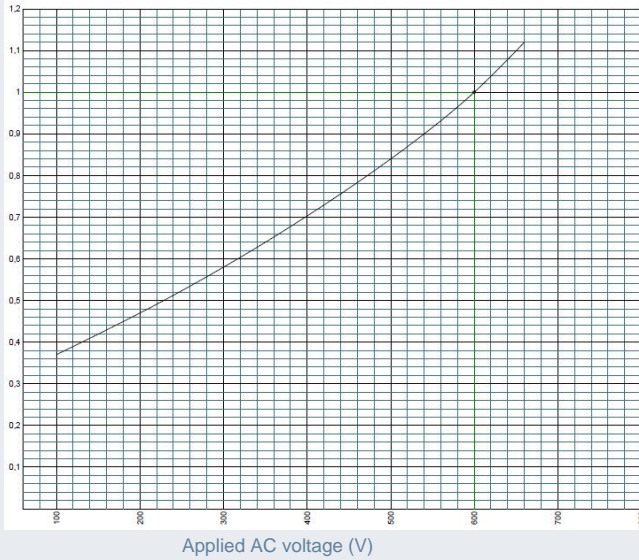

Clearing I²t and arcing time correction factor

Peak let thru characteristics
600V 3600 to 4200A

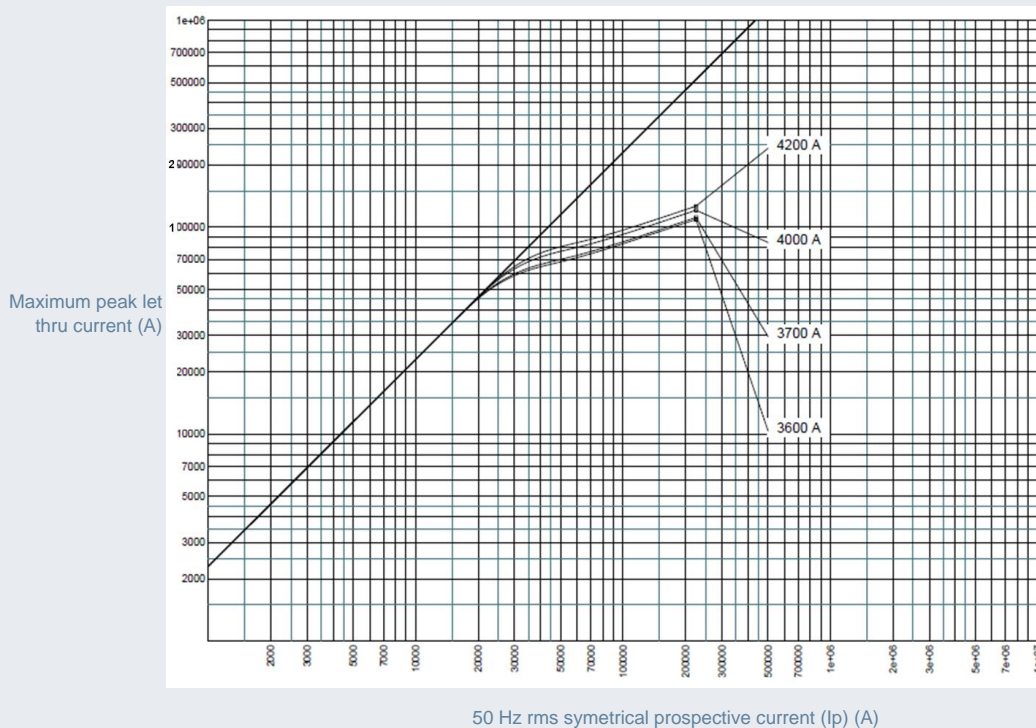

Semiconductor & Special Protection

Protistor® Square body fuse-links

Size 44 aR 500 to 750VAC 1200 to 5750A



Time current characteristics
550V 4400 to 5000A

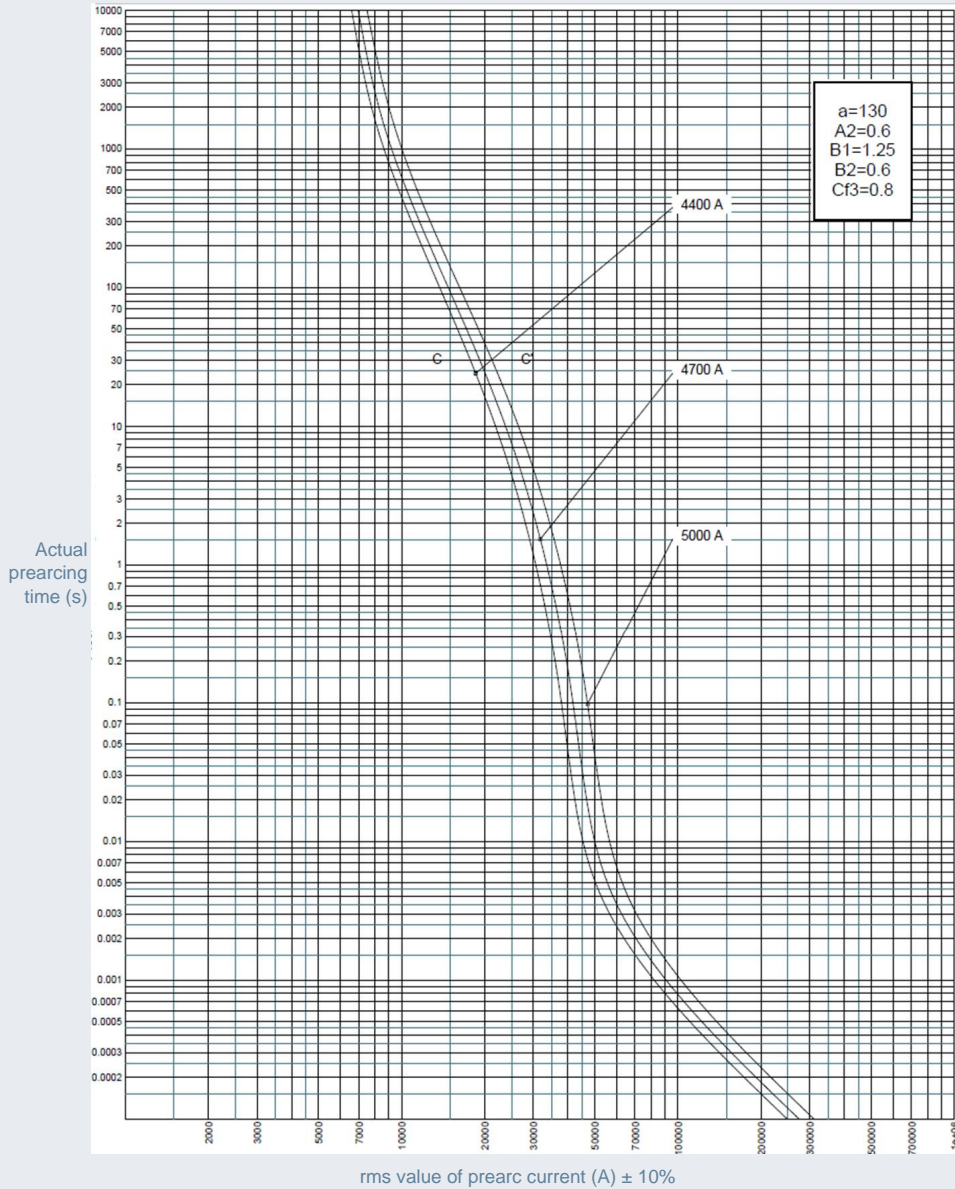

Peak arc voltage
550V 4400 to 5000A

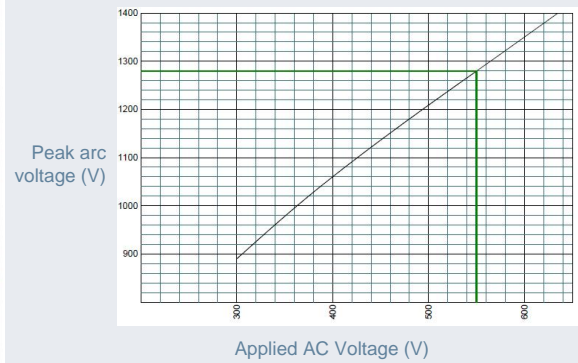

Semiconductor & Special Protection

Protistor® Square body fuse-links

Size 44 aR 500 to 750VAC 1200 to 5750A



I²t multiplier coefficient
550V 4400 to 5000A



Clearing I²t and arcing time correction factor

Peak let thru characteristics
550V 4400 to 5000A

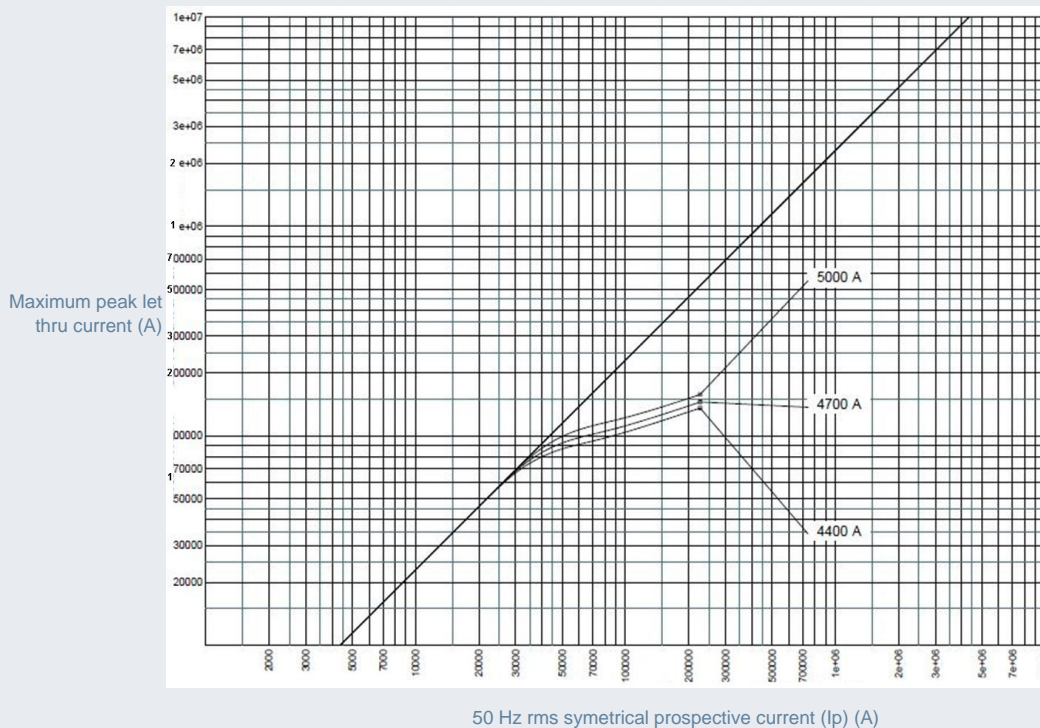

Semiconductor & Special Protection

Protistor® Square body fuse-links

Size 44 aR 500 to 750VAC 1200 to 5750A



Time current characteristics
500V 5750A

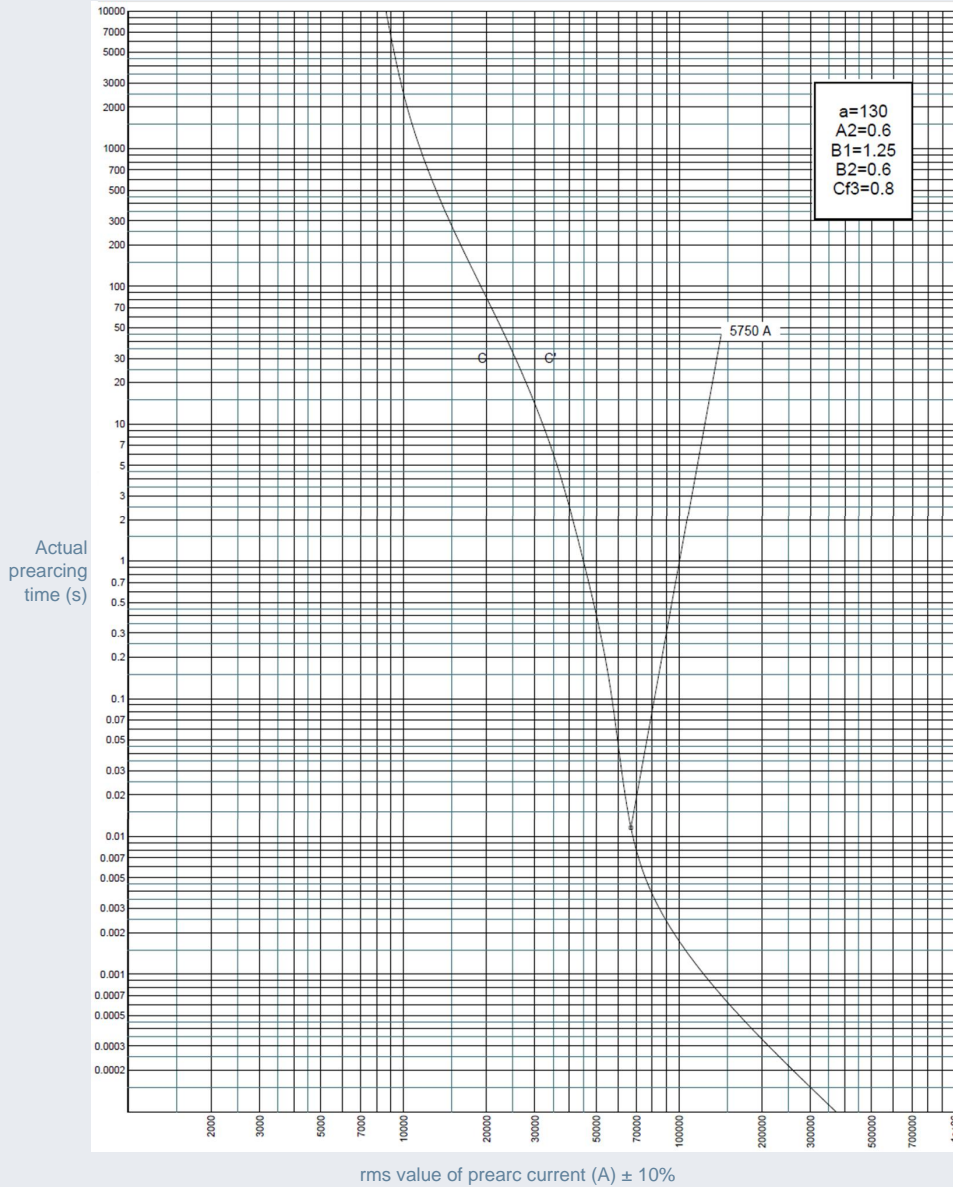

Peak arc voltage
500V 5750A

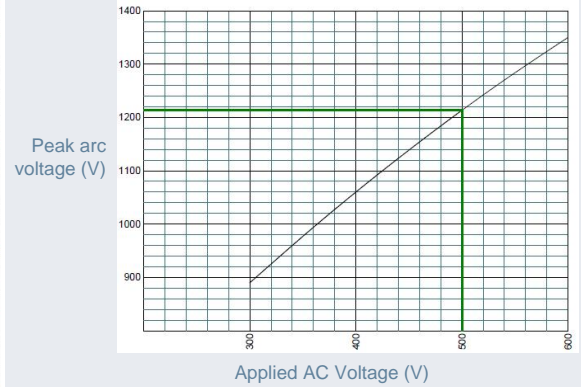

Semiconductor & Special Protection

Protistor® Square body fuse-links

Size 44 aR 500 to 750VAC 1200 to 5750A



**I²t multiplier coefficient
500V 5750A**

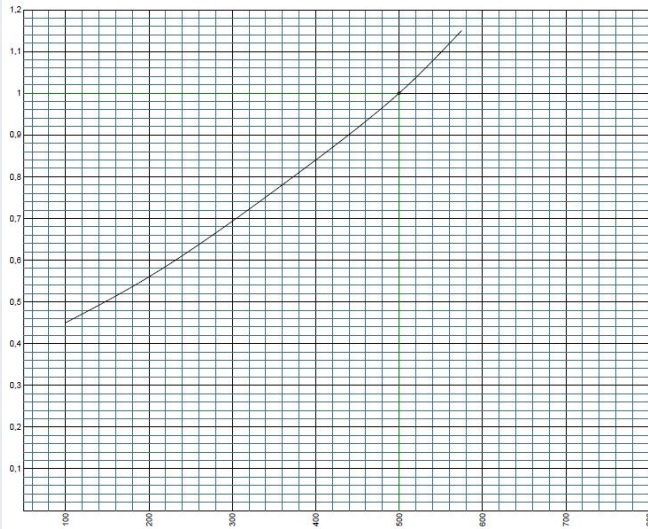

Clearing I²t and arcing time correction factor

Applied AC voltage (V)

**Peak let thru characteristics
500V 5750A**

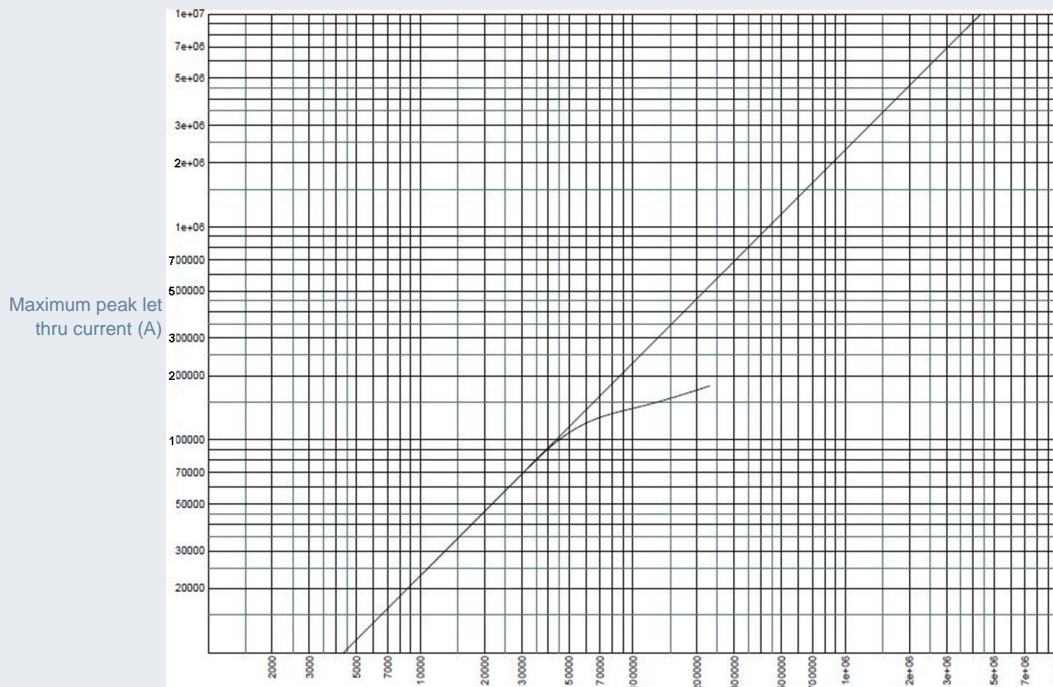

Maximum peak let thru current (A)

50 Hz rms symmetrical prospective current (Ip) (A)