

Conductive Level Controller 61F-GP-N8

Compact Plug-in Level Controllers for Single or Two-point Level Control of Conductive Materials (Liquids and Solids)

- Wide range of models: long-distance, high and low-sensitivity, and two-wired types available.
- 24/100/110/120/200/220/230/240 VAC operation possible.
- Easy installation on DIN track.
- Low-voltage (AC) electrodes.
- Red LED operation indicator provided.
- Conforms to EMC and LVD Directives.
- UL/CSA approved.



Level Controllers

Model Number Structure

Model Number Legend

61F-GP-N8□
1 2 3

1. Plug-in Type
2. Compact 8-pin Type

3. Applications
 - None: General-purpose type
 - L: Long-distance type
 - H: High-sensitivity type (reverse acting)
 - HY: High-sensitivity type (standard acting)
 - D: Low-sensitivity type
 - R: Two-wired type

Ordering Information

List of Models

Application		Model number
General-purpose type		61F-GP-N8
Long-distance type	2 km	61F-GP-N8L 2KM
	4 km	61F-GP-N8L 4KM
High-sensitivity type		61F-GP-N8H
Low-sensitivity type		61F-GP-N8D
Two-wired type		61F-GP-N8R

■ Accessories (Order Separately)

Selection Guide for Electrode Holders and Separators

Electrode Holders

Applications	For city water and other general-use electrodes. Easy-to-replace separate versions facilitate maintenance of electrodes.	When mounting space is limited. Special 3-pole holder of small size and light weight. Ideal for soft drink vendors, etc., where only limited space is available.	For low specific liquids. Used for sewage, sea water, etc., having a low specific resistance. In sewage use, electrode holders must be installed 10 to 20 cm apart from one another. For acids, alkalis and sea water, electrode holders may be as much as 1 meter apart to operate properly.	When resistance to high pressure is required. Ideal for use in tanks where temperature or pressure inside the tank is high, e.g. 250°C	
Mounting style	Flange	Screw	Flange	Screw	
Insulator material	Phenol resin	Phenol resin	Ceramics	PFA	
Max. temperature	70°C		150°C (without water drips or vapor on the surface of the electrode holder)	250°C (without water drips or vapor on the surface of the electrode holder)	
No. of electrodes	1	---	---	BF-1	BS-1
	3	PS-3S	PS-31	---	---

Electrode Separators

No. of electrodes	Model
1	F03-14 1P
3	F03-14 3P

Selection Guide for Electrodes, Connecting, and Lock Nuts

Applicable liquids	Material	Models for individual electrode assembly components					
		Electrode (1m long)		Connecting nut		Lock nut	
		Model	Indication mark	Model	Inscription	Model	Inscription
Purified city water, industrial water, sewage	Equivalent to SUS 304 (AISI-304)	F03-01 SUS201	1 line	F03-02 SUS201	---	F03-03 SUS201	---
Purified city water, industrial water, sewage, dilute alkaline solution	SUS316 (AISI-316)	F03-01 SUS316	2 lines	F03-02 SUS316	6	F03-03 SUS316	316

Specifications

■ Ratings and Characteristics

Model/Items	General-purpose Controller 61F-GP-N8	Long-distance Controllers 61F-GP-N8L 2KM (for 2 km) 61F-GP-N8L 4KM (for 4 km)	High-sensitivity Controllers 61F-GP-N8H 61F-GP-N8HY (see note 1)	Low-sensitivity Controller 61F-GP-N8D	Two-wired Controller 61F-GP-N8R
Controlling materials and operating conditions	For control of ordinary purified water or sewage water	For control of ordinary purified water in cases where the distance between sewage pumps and water tanks or between receiver tanks and supply tanks is long or where remote control is required.	For control of liquids with high specific resistance such as distilled water	For control of liquids with low specific resistance such as salt water, sewage water, acid chemicals, alkali chemicals	For control of ordinary purified water or sewage water used in combination with two-wired-type electrode holder (incorporating a resistor of 6.8 kΩ)
Supply voltage	24, 100, 110, 120, 200, 220, 230 or 240 VAC; 50/60 Hz				
Operating voltage range	85% to 110% of rated voltage				
Interelectrode voltage	8 VAC		24 VAC	8 VAC	
Interelectrode current	Approx. 1 mA AC max.		Approx. 0.4 mA AC max.	Approx. 1 mA AC max.	
Power consumption	Approx. 3.5 VA max.				
Interelectrode operate resistance	Approx. 0 to 4 kΩ	Approx. 0 to 1.3 kΩ (for 2 km) Approx. 0 to 0.5 kΩ (for 4 km)	Approx. 15 kΩ to 70 kΩ (see note 3)	Approx. 0 to 1.3 kΩ	Approx. 0 to 2 kΩ
Interelectrode release resistance	Approx. 15 k to ∞ Ω	Approx. 4 k to ∞ Ω (for 2 km) Approx. 2.5 k to ∞ Ω (for 4 km)	Approx. 300 k to ∞ Ω	Approx. 4 k to ∞ Ω	Approx. 15 k to ∞ Ω
Response time	Operate: 80 ms max. Release: 160 ms max.				
Cable length (see note 2)	1 km max.	2 km max. 4 km max.	50 m max.	1 km max.	800 m max.
Control output	1 A, 250 VAC (Inductive load: $\cos\phi = 0.4$) 3 A, 250 VAC (Resistive load)				
Ambient temperature	Operating: -10°C to 55°C				
Ambient humidity	Operating: 45% to 85% RH				
Insulation resistance (see note 3)	100 MΩ max. (at 500 VDC)				
Dielectric strength (see note 4)	2000 VAC, 50/60 Hz for 1 min.				
Life expectancy	Electrical: 100,000 operations min. Mechanical: 5,000,000 operations min.				

- Note:**
1. The relay in the 61F-GP-N8H de-energizes when there is water present across the electrodes, whereas the relay in the 61F-GP-N8HY energizes when there is water present across the electrodes.
 2. The length when using completely-insulated, 600-V, 3-conductor (0.75 mm²) cable type cables. Usable cable lengths will become shorter as the cable diameter or number of conductors becomes larger.
 3. The insulation resistance and dielectric strength indicate values between power terminals and electrode terminals, between power terminals and contact terminals, and between electrode terminals and contact terminals.
 4. Possible to use with 10 kΩ or less, however, this may cause reset failure.

Connections

Internal Circuit Diagrams

61F-GP-N8/-N8L/-N8D/-N8HY

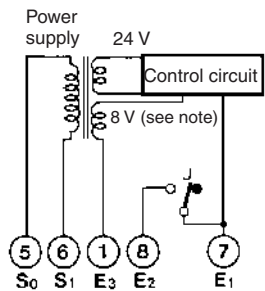

61F-GP-N8H

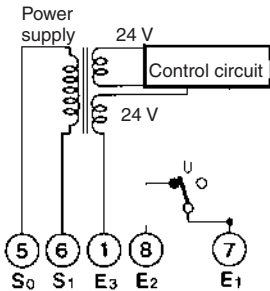

61F-GP-N8R

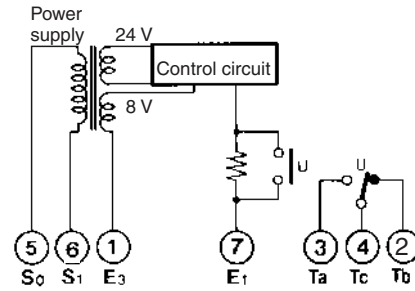

Note: 24 V for the 61F-GP-N8HY.

Automatic Water Supply and Drainage Control

1. Water Supply

- Connect electromagnetic switch coil terminal A to terminal 2.
- The pump stops when the water level reaches E1 and starts when the water level drops below E2.

2. Drainage

- Connect the electromagnetic switch coil terminal A to terminal 3.
- The pump starts when the water level reaches E1 and stops when the water level drops below E2.

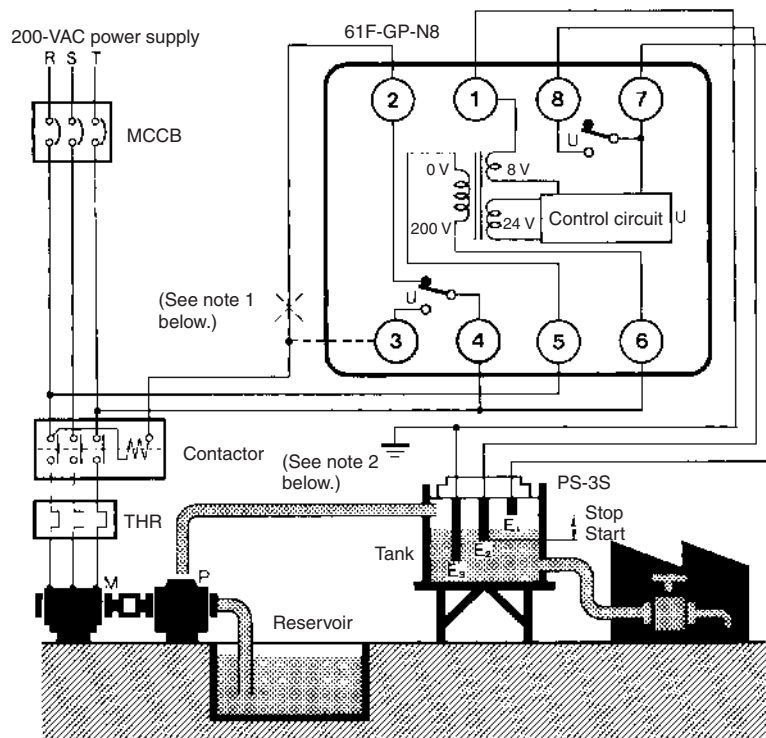

- Note: 1. The diagram shows the connections for water supply. When draining, change the connection from terminal 2 to terminal 3.
 2. The earth terminal must be earthed.

Operation

The Conductive Level Controller consists of a plug-in controller connected to a set of stainless steel probes. These are cut to length and inserted vertically into the liquid. A low voltage is applied between these probes and the earth probe (or tank, if it is electrically conductive). The water provides a current between the earth probe and the high-level probe. The output relay in the Controller is energized when the water level reaches the high-level probe and de-energized when the water level falls below it.

For two-point control a low-level probe is used as well. In this case the relay does not de-energize until the water level falls below the low-level probe. Using the low-level probe allows a wide differential between switching a pump on and off, and can avoid excessive pump operation during tank emptying or filling. If this differential is not required, the low-level probe need not be connected.

Surge Suppressor Unit (61F-03B/04B)

A high-capacity protective device is available which protects 61F-series Floatless Level Controllers against faults arising from electrical surges (such as indirect strokes of lightning) when the Controllers are employed in elevated water tanks or in high-altitude locations.

Specifications

Discharge start voltage	90 V ±20 VDC
Impulse withstand voltage	200,000 V (1 x 40 μs)
Impulse withstand current	6,000 A (1 x 40 μs)

Internal Connections

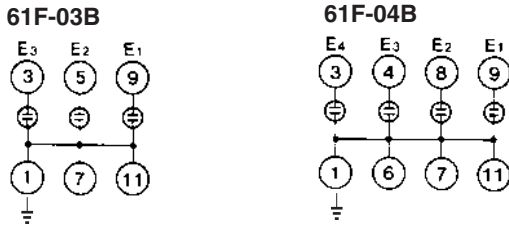

Precautions

1. Mount the Surge Suppressor Unit as close to the Controller as possible.
2. When grounding the Surge Suppressor Unit in the vicinity of the Controller, connect the ground side of the Surge Suppressor Unit to electrode E3.

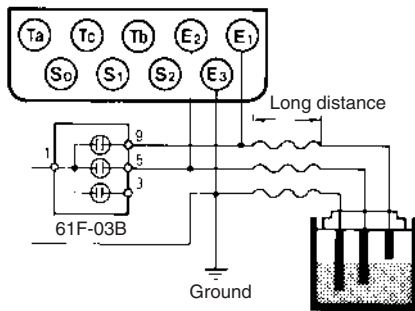

3. When connecting the Surge Suppressor Unit, wire as shown in the following example (with three electrodes).

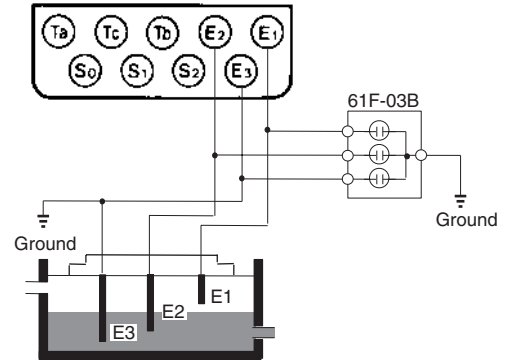

Connection Sockets

- PF113A-E Track-mounted Socket
- PL11 Back-connecting Socket

Level Controllers

Dimensions

Note: All units are in millimeters unless otherwise indicated.

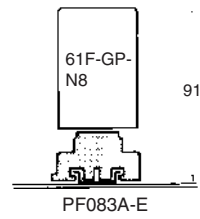
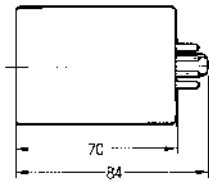
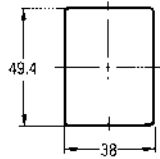

Electrode Holders

PS-□S

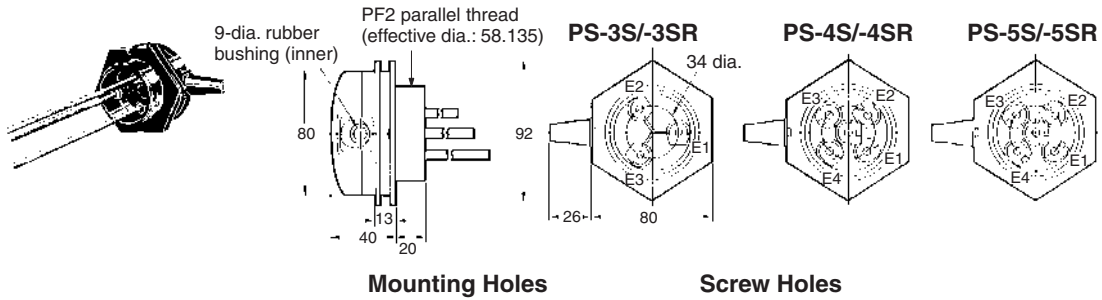

Mounting Holes

Screw Holes

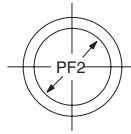

Used with coupling



Used with mounting bracket

PS-31

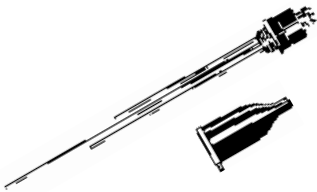

Dust preventive rubber cap (optional)

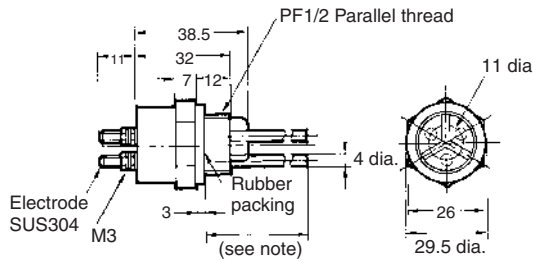

Mounting Holes



Note: Standard holder construction includes three integral 300-mm-long electrodes. However, a model having 1,000-mm-long electrodes is available on request.

BF-1

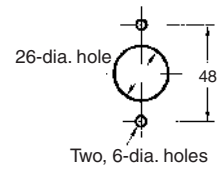
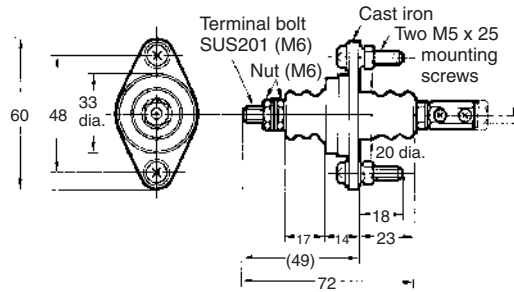

BS-1

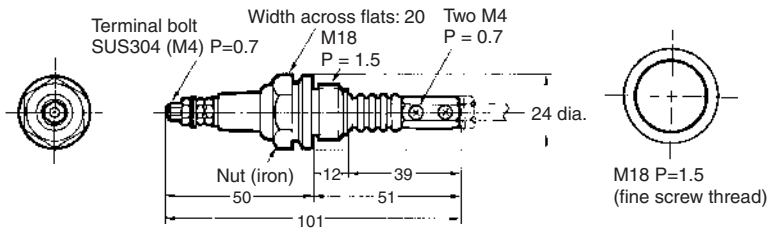
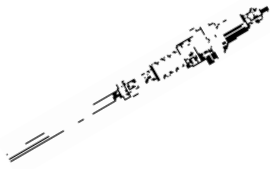

Electrode Separators

F03-14 1P (for Single Pole)

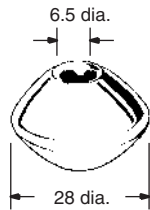

F03-14 3P (for Three Poles)

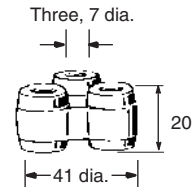

Connecting Sockets

Track Mounted Socket

PF083A-E

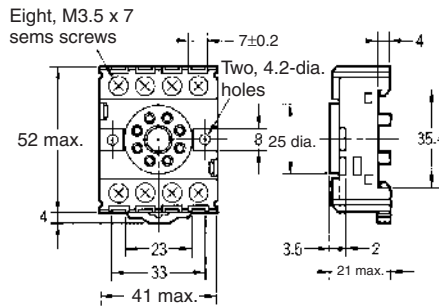
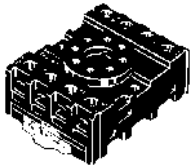

Terminal Arrangement/
 Internal Connections
 (Top View)

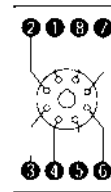

Mounting Holes

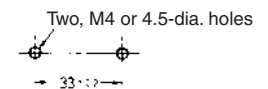

Back Connecting Socket

PL08

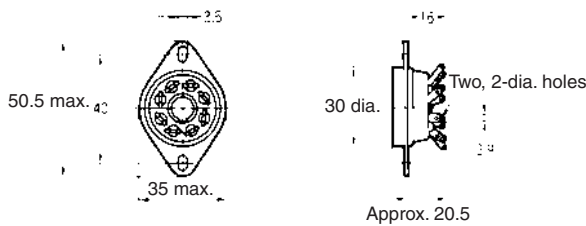

Terminal arrangement/
 Internal Connections
 (Bottom View)

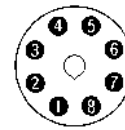

Mounting Holes

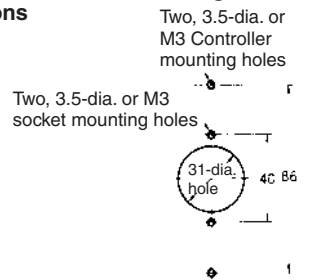

Holding Brackets

To mount the 61F-GP-N8 Conductive Level Controller on the PF083A Track Mounted Socket, use the PFC-N8 Mounting Brackets attached to the Socket as an accessory.

PFC-N8

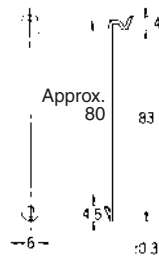

Surge Suppressor Unit

61F-03B
61F-04B

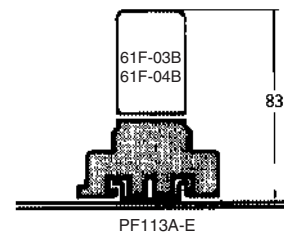
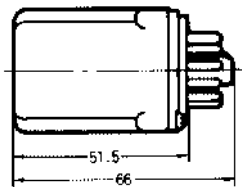
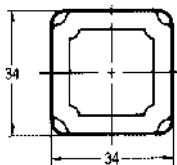
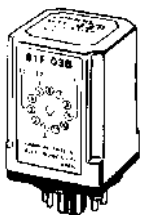

Application Examples

- Level control in tanks, reservoirs, sewage plants, underground wells, mixing plants etc.
- Level control for element protection in pipes, channels, and irrigation systems.
- Flow detection in pipes, channels, and irrigation systems.
- Ice bank control in cold drink dispensers, ice makers, water chillers, bulk milk tanks, etc.
- Dispensing of liquids by volume.
- Indication of liquid buildup due to filter blockages.
- Pollution/foul water detection for rivers, drains, etc.
- Alarm control warning of abnormal or dangerously high or low levels.

Application

When using electrodes in sea water or sewage, provide a sufficient interval (normally 1 m) between the electrodes. If the sufficient interval cannot be provided, employ a low-sensitivity-type Floatless Level Controller.

When taping one of the electrodes to prevent it from contacting the other electrodes in water, do not tape the electrode entirely but leave at least 100 mm of its end uncovered.

When the required length of the electrode is more than 1 m, use a separator at each joint of two electrodes so as to prevent the electrodes from contacting one another.

Note: Avoid use of the separators in dust-containing liquids.

Usually, electrodes are used in a set of three: long, medium, and short. Connect the short electrode to E1, the medium electrode to E2, and the long electrode to E3. Make E3 at least 50 mm longer than E2.

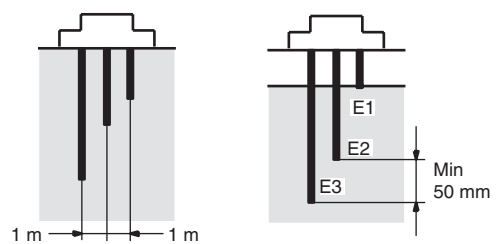

Electrodes are in actual contact with the liquid. Standard electrodes are made of stainless steel and usable in purified water, sea water, sewage, acid (except acetic acid, sulfuric acid, etc.) and alkaline liquids, although they may corrode depending upon the temperature and working conditions.

Note that the 61F-GP-N8 Conductive Level Controller is capable of controlling liquids with specific resistances of up to 30 kΩ-cm when the Controller employs a PS-3S electrode holder with the electrode(s) submerged to a depth of 30 mm max.

Kind of water	Specific resistance	Applicable type
City water	5 to 10 kΩ-cm	Standard type
Well water	2 to 5 kΩ-cm	Standard type
Industrial water	5 to 15 kΩ-cm	Standard type
Rainwater	15 to 25 kΩ-cm	Standard type
Sea water	0.03 kΩ-cm	Low-sensitivity type
Sewage	0.5 to 2 kΩ-cm	Low-sensitivity type
Distilled water	100 kΩ-cm or less	High-sensitivity type
	Over 100 kΩ-cm	Consult OMRON

Precautions

■ How to Mount Electrodes

Connecting Electrodes to Electrode Holders

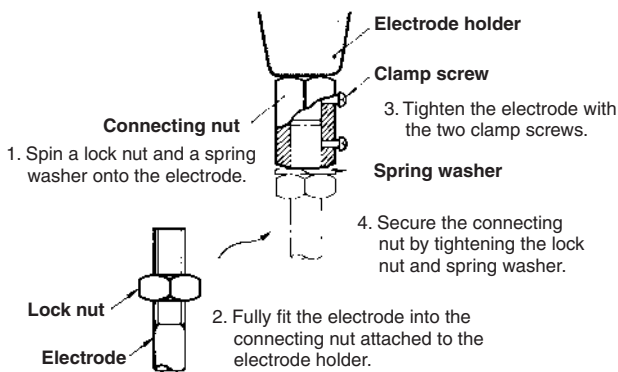

Connecting One Electrode to Another

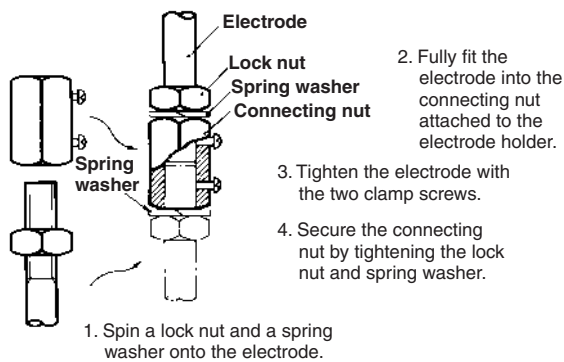

ALL DIMENSIONS SHOWN ARE IN MILLIMETERS.

To convert millimeters into inches, multiply by 0.03937. To convert grams into ounces, multiply by 0.03527.

Cat. No. F043-E1-02

In the interest of product improvement, specifications are subject to change without notice.