



## Advanced fiber optic amplifiers for high speed and low contrast applications

- DIN rail mountable models with dual digital displays
- High speed models: 200  $\mu$ s...5 ms
- Super high speed models: 10  $\mu$ s...1ms
- Teach-in setting via +/-SET/- push-button/switch, remote input or IO-Link
- Standard 2 m cable or M8 4-pole connection



SENSORS

### APPLICATIONS

- Processing and Packaging machinery
- Electronics assembling
- Pharmaceutical industry



S70		
Response time	Super high speed: 10 $\mu$ s (S70...E2) High speed: 200 $\mu$ s (S70...E1), 15 $\mu$ s (S70...E2) Fast: 50 $\mu$ s (S70...E2) Standard: 500 $\mu$ s (S70...E1), 250 $\mu$ s (S70...E2) Medium range: 500 $\mu$ s (S70...E2) Long range: 2 ms (S70...E1), 1 ms (S70...E2) Extra long range: 5 ms (S70...E1)	
Power supply	Vdc	10...30 V, 18...30 V (IO-Link mod.)
	Vac	
	Vac/dc	
Output	PNP	▪
	NPN	▪
	NPN/PNP	
	relay	
	other	IO-Link
Connection	cable	▪
	connector	▪
	pig-tail	
Approximate dimensions (mm)	10x79x31.5	
Housing material	ABS and polycarbonate	
Mechanical protection	IP50, NEMA 1	

## TECHNICAL DATA

Power supply	10...30 Vdc (reverse polarity protection) 18...30 Vdc (IO-Link mod. S70...PZ)
Ripple	10% max.
Consumption (output current excluded)	40 mA max.
Light emission	red 660 nm (mod. S70...E1) red 635 nm (mod. S70...E2)
Setting	+ / SET / - push-button, LIGHT / DARK switch, RUN / PRG / ADJ mode switch
Indicators	yellow OUTPUT LED red SIGNAL LEVEL 4-digit display green THRESHOLD 4-digit display
Output	PNP or NPN PNP and push-pull (IO-Link mod. S70...PZ)
Output current	100 mA max.
Saturation voltage	1,5 V max. (mod. S70...N) 2 V max. (mod. S70...P/PZ)
Response time	S70...E1: 200 µs (High Speed), 500 µs (Standard), 2 ms (Long Range), 5 ms (Extra Long Range) S70...E2: 10 µs (Super High Speed), 15 µs (High Speed), 50 µs (Fast), 250 µs (Standard), 500 µs (Medium Range), 1 ms (Long Range)
Switching frequency	S70...E1: 2,5 kHz (High Speed), 1 kHz (Standard), 250 Hz (Long Range), 100 Hz (Extra Long Range) S70...E2: 50 kHz (Super High Speed), 33 kHz (High Speed), 10 kHz (Fast), 2 kHz (Standard), 1 kHz (Medium Range), 500 Hz (Long Range)
Connection	2 m cable, M8 4-pole connector
Dielectric strength	500 Vac, 1 min between electronics and housing
Insulating resistance	>20 MΩ, 500 Vdc between electronics and housing
Electrical protection	class 2
Mechanical protection	IP50, NEMA 1
Ambient light rejection	according to EN 60947-5-2
Vibrations	0,5 mm amplitude, 10 ... 55 Hz frequency, for every axis (EN60068-2-6)
Shock resistance	11 ms (30 G) 6 shock for every axis (EN60068-2-27)
Housing material	ABS
Operating temperature	-10 ... 55 °C
Storage temperature	-25 ... 85 °C
Weight	69 g max. cable vers., 21 g max. conn. vers.

## DIMENSIONS

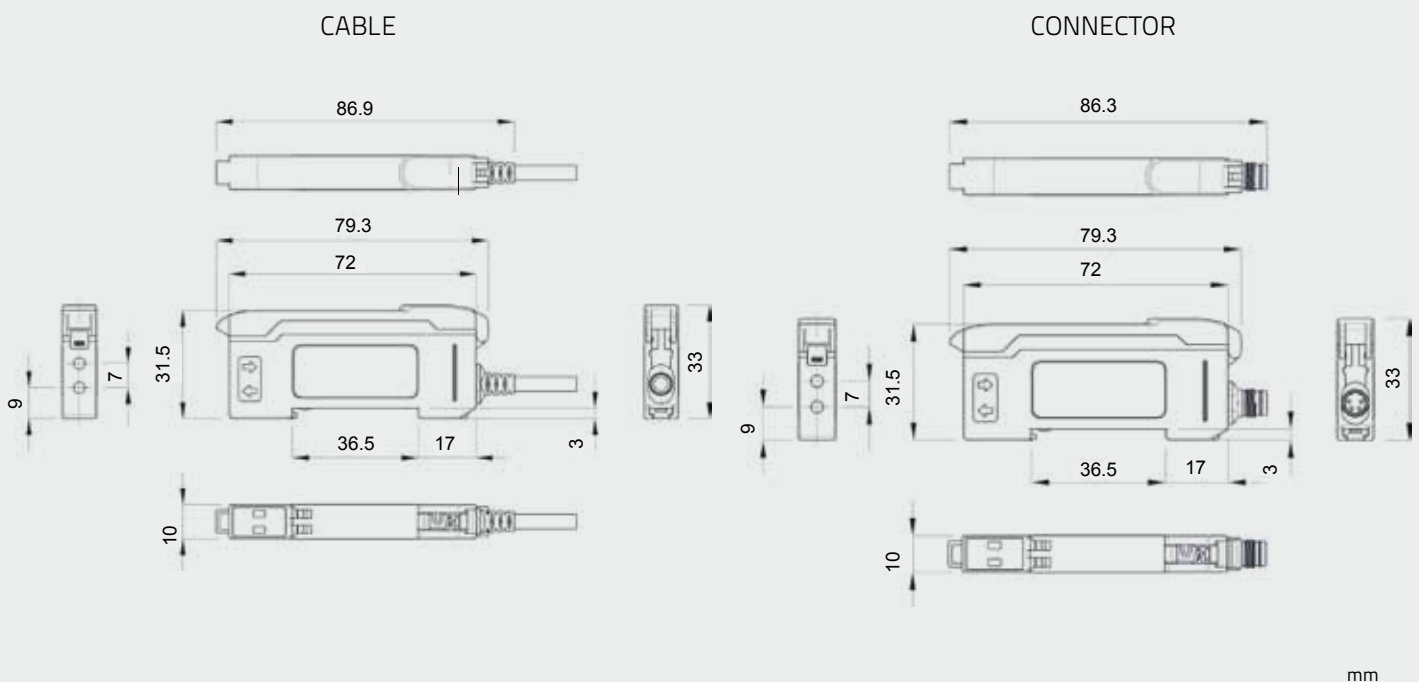

## MAIN FEATURES

The S70 is a high performance fiber optic amplifier with dual digital displays showing both signal level and threshold simultaneously. This advanced series ensures simple set-up and programming via displays and switches, push-button, remote input or IO-Link interface.

Two S70 amplifiers can operate in close proximity to avoid interference thanks to a cross-talk algorithm. There is a temperature compensation feature to allow the side-by-side mounting of multiple fiber amplifiers.

S70 is a compact and DIN rail mountable fiber optic amplifier with best in class response speed and repeatability. Two versions with different selectable response times are available: S70-E1 and S70-E2.

All models work with any 2.2 mm fiber optic cable and the operating distance is determined by the optic fiber and accessory lens used and the response speed selected in the specific model.

## SETTINGS AND INDICATORS

The **RUN/PRG/ADJ Mode Switch** puts the sensor in RUN, PRG (Program), or ADJ (Adjust) mode. RUN mode allows the sensor to operate normally and prevents unintentional programming changes via the **+ /SET/ - button**. PRG mode allows the sensor to be programmed through the display driven programming menu. ADJ mode allows the user to perform TEACH and SET methods and Manual Adjust.

The **LO/DO Switch** is used to select Light Operate or Dark Operate mode.

### Top Panel Interface



1	Output LED
2	LO/DO Switch
3	RUN/PRG/ADJ Mode Switch
4	Lever Action Fiber Clamp
5	Red Signal Level
6	Green Threshold
7	+ /SET/ - Rocker Button

As an alternative the sensor can be programmed remotely and the remote input may be used to perform TEACH and SET methods (not available on IO-Link models).

## CONNECTIONS

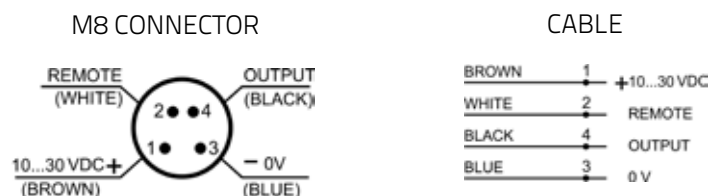

### IO-Link® Sensors

With IO-Link interface, S70-5-E1-PZ can achieve point-to-point communication, allowing for remote configuration and monitoring capabilities. Designed to facilitate communication between sensors and actuators from different manufacturers and higher-level systems, the fieldbus-independent IO-Link serial communication protocol offers a uniform standard that applies to all manufacturers.

## S70-E1

	HIGH SPEED	STANDARD	LONG RANGE	EXTRA LONG RANGE
Response Time	200 $\mu$ s	500 $\mu$ s	2 ms	5 ms
Repeatability	66 $\mu$ s	100 $\mu$ s	100 $\mu$ s	100 $\mu$ s

## DETECTION DIAGRAM

### Excess gain

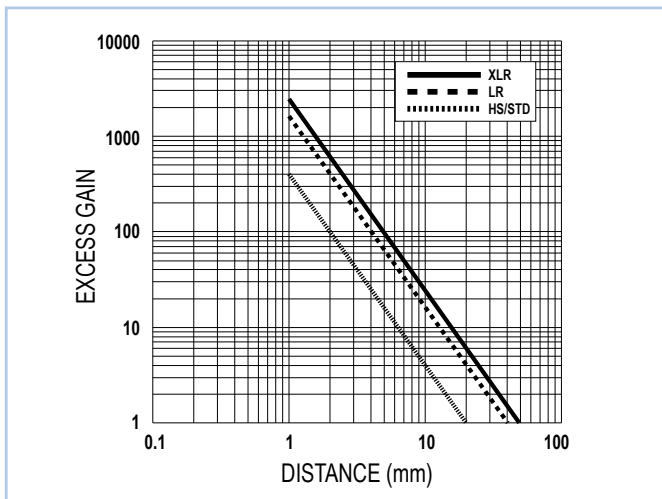

Through beam with 0.2 mm internal fiber optic diameter

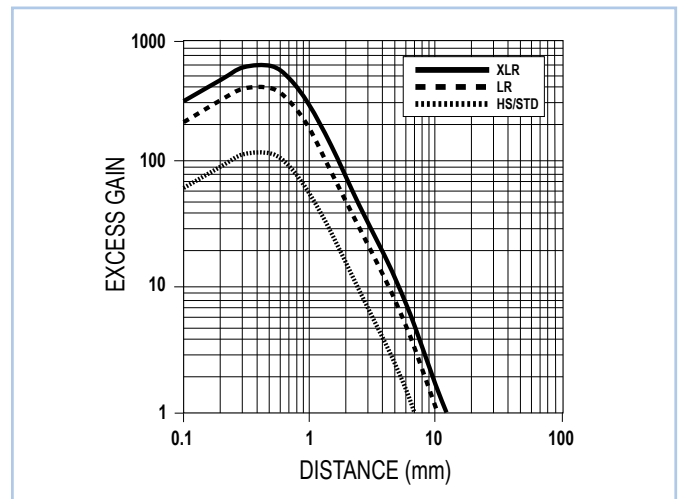

Diffuse proximity with 0.2 mm internal fiber optic diameter

### Excess gain

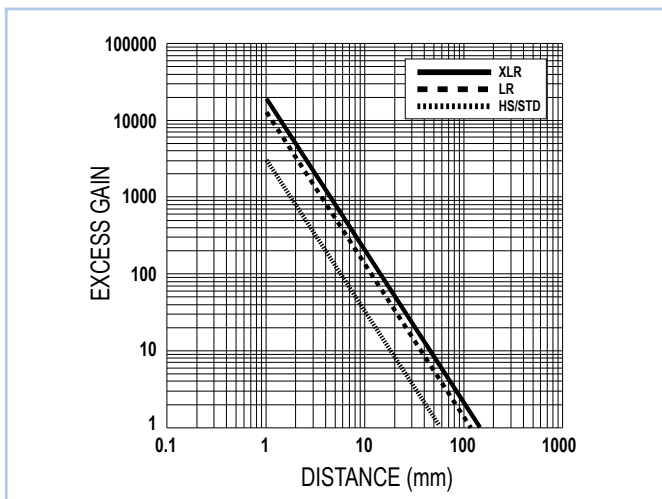

Through beam with 0.5 mm internal fiber optic diameter

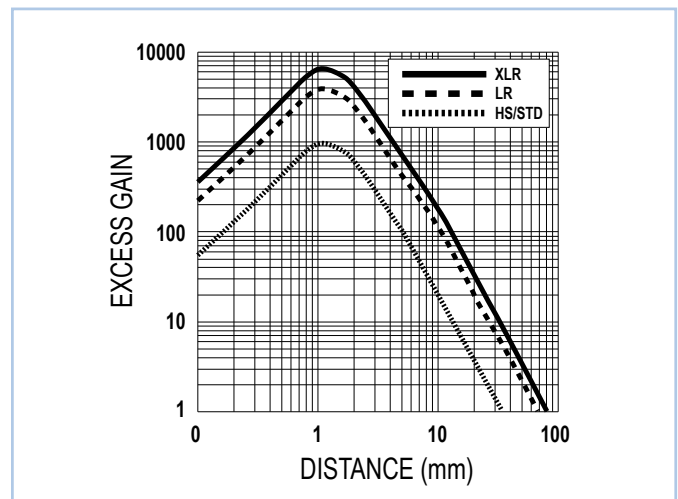

Diffuse proximity with 0.5 mm internal fiber optic diameter

## S70-E1

	HIGH SPEED	STANDARD	LONG RANGE	EXTRA LONG RANGE
Response Time	200 $\mu$ s	500 $\mu$ s	2 ms	5 ms
Repeatability	66 $\mu$ s	100 $\mu$ s	100 $\mu$ s	100 $\mu$ s

## DETECTION DIAGRAM

### Excess gain

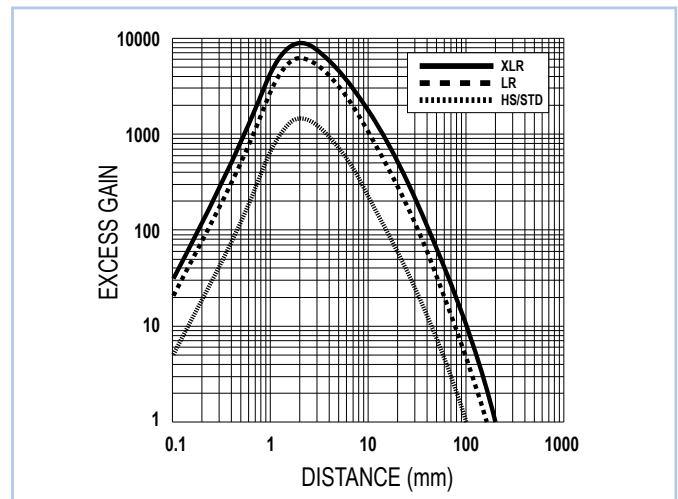
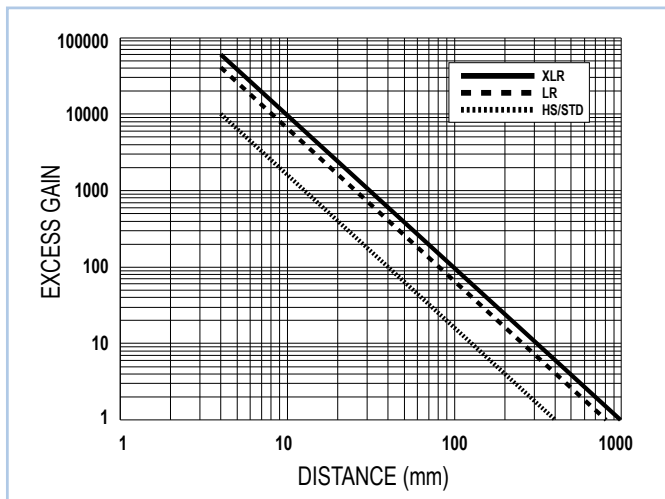

### Excess gain

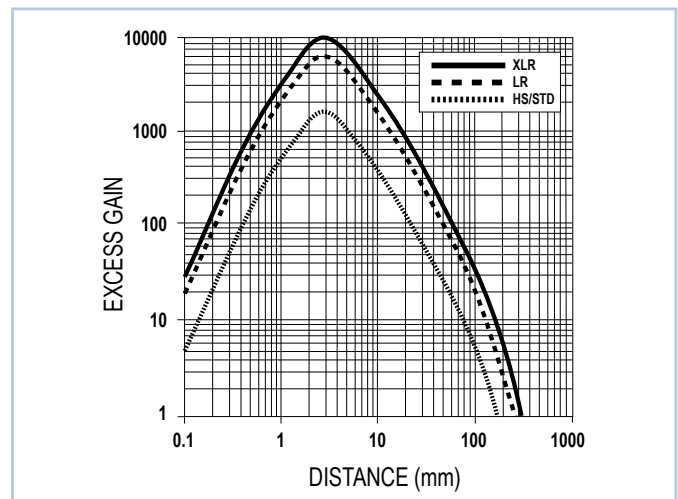
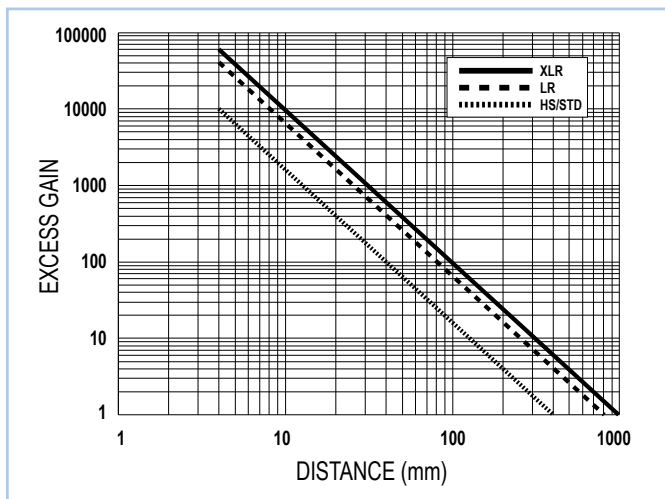

## S70-E1

	HIGH SPEED	STANDARD	LONG RANGE	EXTRA LONG RANGE
Response Time	200 $\mu$ s	500 $\mu$ s	2 ms	5 ms
Repeatability	66 $\mu$ s	100 $\mu$ s	100 $\mu$ s	100 $\mu$ s

## DETECTION DIAGRAM

### Detection area

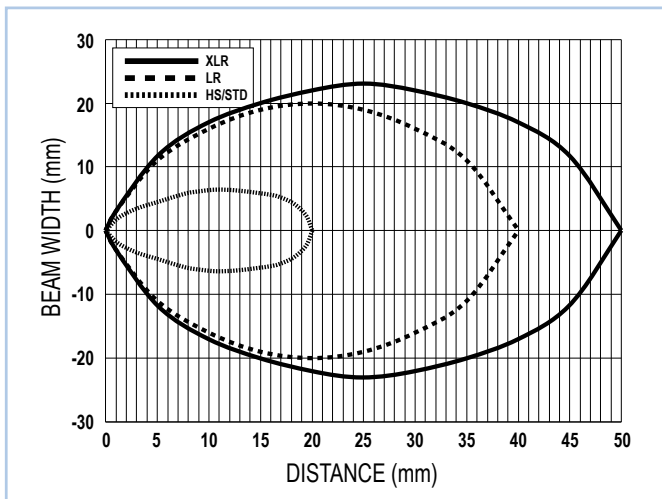

Through beam with 0.2 mm internal fiber optic diameter

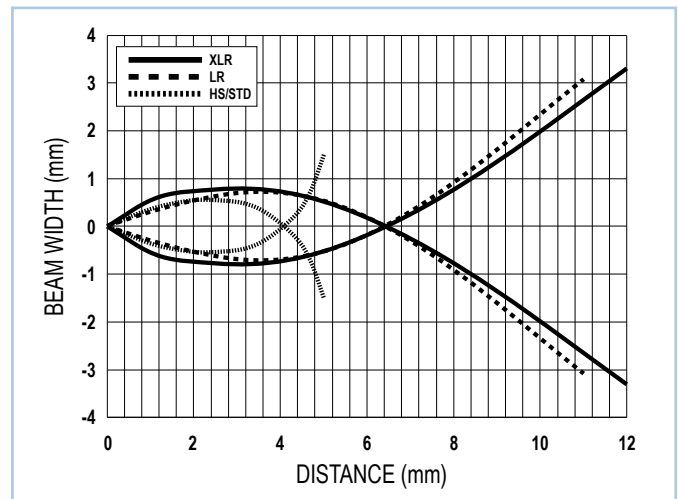

Diffuse proximity with 0.2 mm internal fiber optic diameter

### Detection area

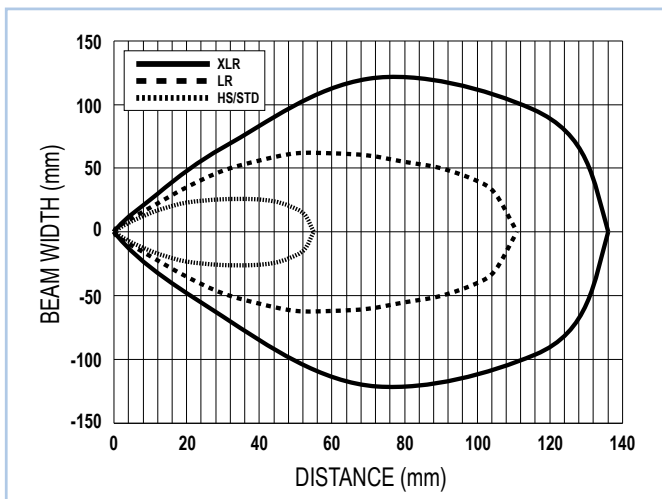

Through beam with 0.5 mm internal fiber optic diameter

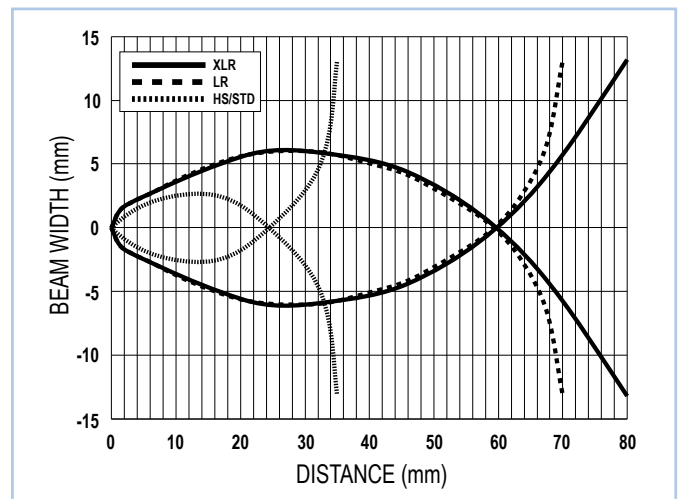

Diffuse proximity with 0.5 mm internal fiber optic diameter

## S70-E1

	HIGH SPEED	STANDARD	LONG RANGE	EXTRA LONG RANGE
Response Time	200 $\mu$ s	500 $\mu$ s	2 ms	5 ms
Repeatability	66 $\mu$ s	100 $\mu$ s	100 $\mu$ s	100 $\mu$ s

## DETECTION DIAGRAM

### Detection area

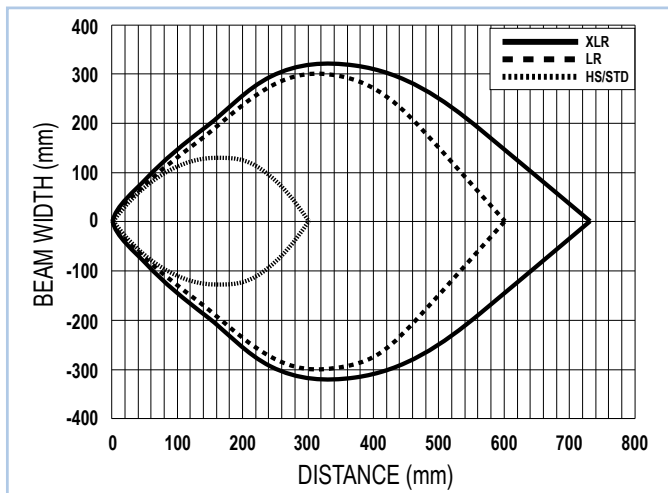

Through beam with 1 mm internal fiber optic diameter

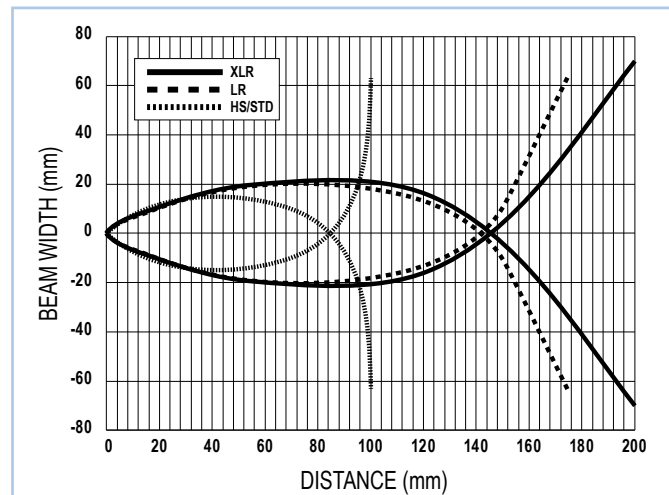

Diffuse proximity with 1 mm internal fiber optic diameter

### Detection area

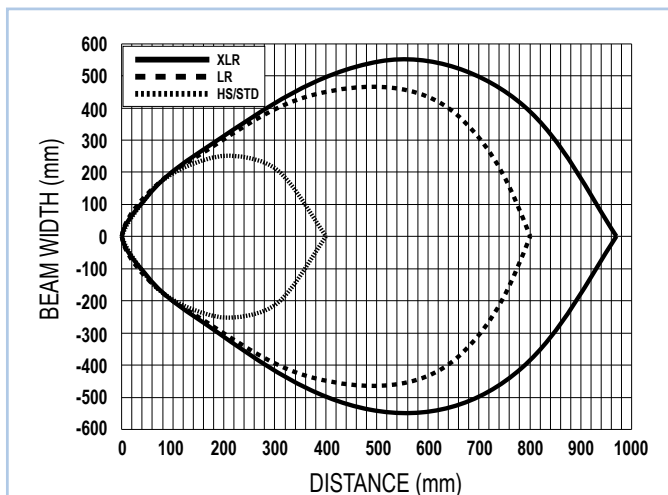

Through beam with 1.5 mm internal fiber optic diameter

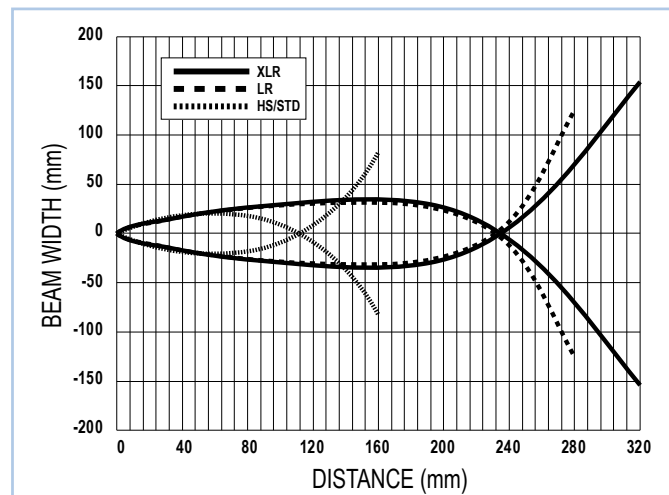

Diffuse proximity with 1.5 mm internal fiber optic diameter

## S70-E2

	SUPER HIGH SPEED	HIGH SPEED	FAST	STANDARD	MEDIUM RANGE	LONG RANGE
Response Time	10 $\mu$ s	15 $\mu$ s	50 $\mu$ s	250 $\mu$ s	500 $\mu$ s	1 ms
Repeatability	5 $\mu$ s	5 $\mu$ s	12 $\mu$ s	50 $\mu$ s	80 $\mu$ s	165 $\mu$ s

## DETECTION DIAGRAM

### Excess gain

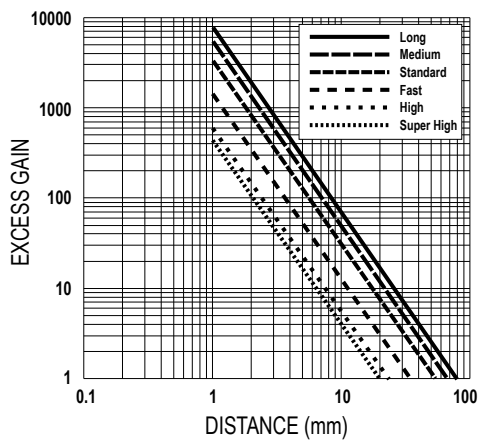

Through beam with 0.2 mm internal fiber optic diameter

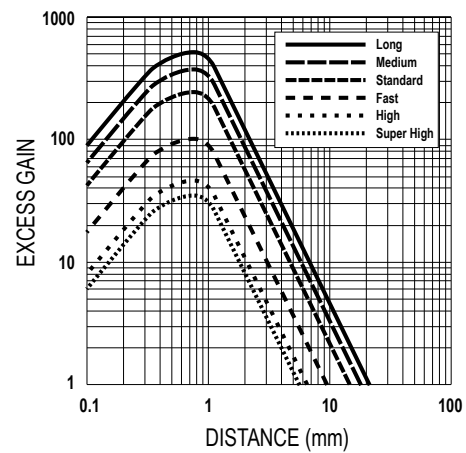

Diffuse proximity with 0.2 mm internal fiber optic diameter

### Excess gain

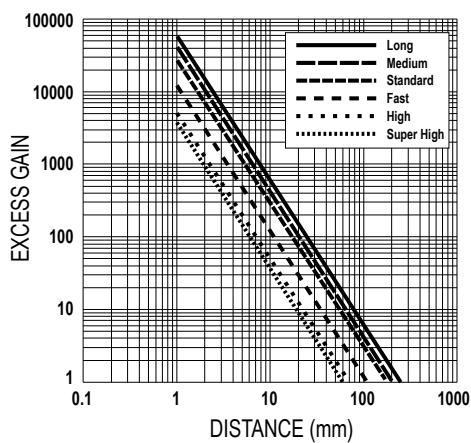

Through beam with 0.5 mm internal fiber optic diameter

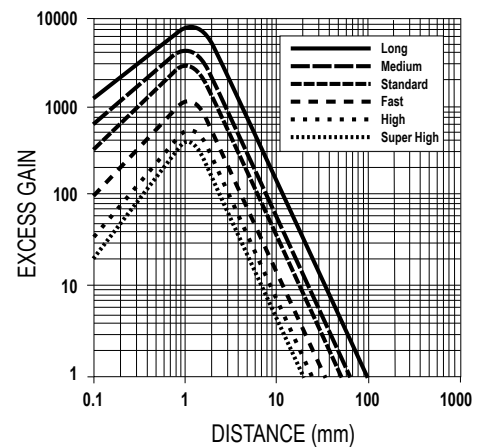

Diffuse proximity with 0.5 mm internal fiber optic diameter



## S70-E2

	SUPER HIGH SPEED	HIGH SPEED	FAST	STANDARD	MEDIUM RANGE	LONG RANGE
Response Time	10 $\mu$ s	15 $\mu$ s	50 $\mu$ s	250 $\mu$ s	500 $\mu$ s	1 ms
Repeatability	5 $\mu$ s	5 $\mu$ s	12 $\mu$ s	50 $\mu$ s	80 $\mu$ s	165 $\mu$ s

## DETECTION DIAGRAM

### Excess gain

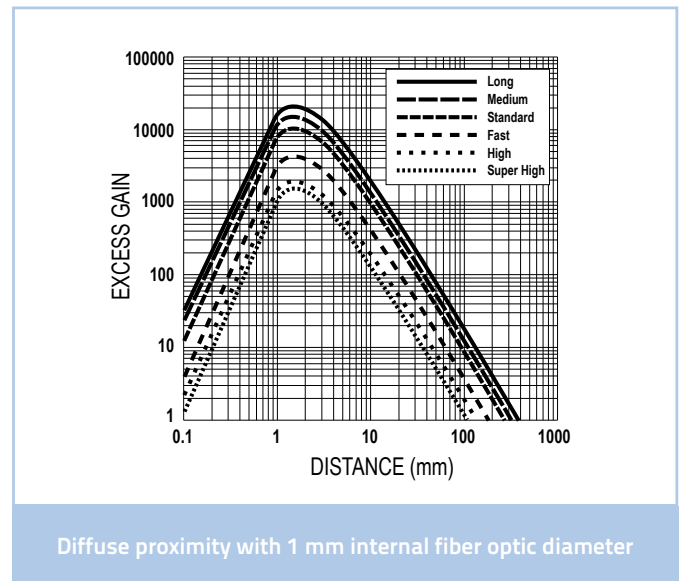
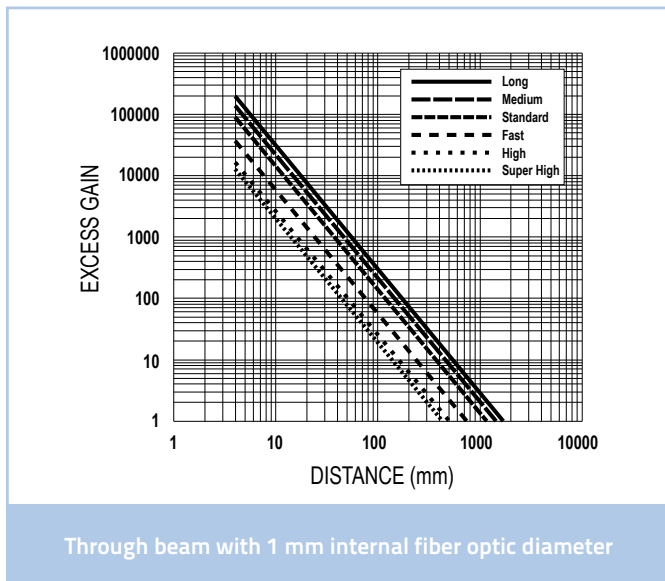

### Excess gain

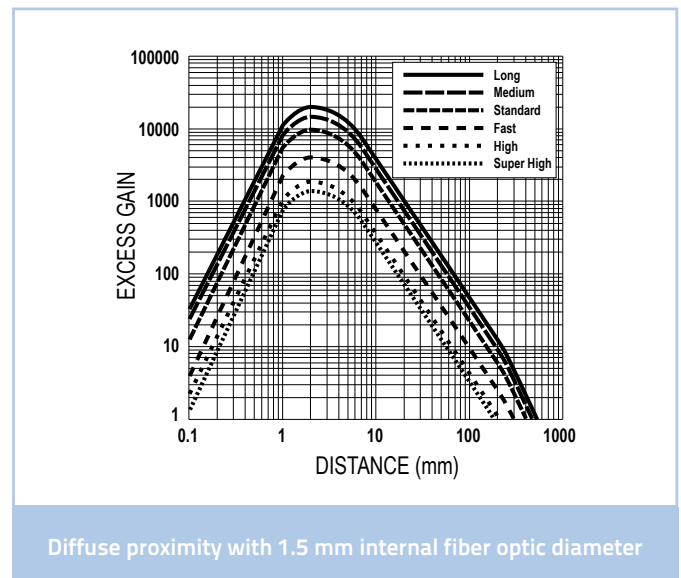
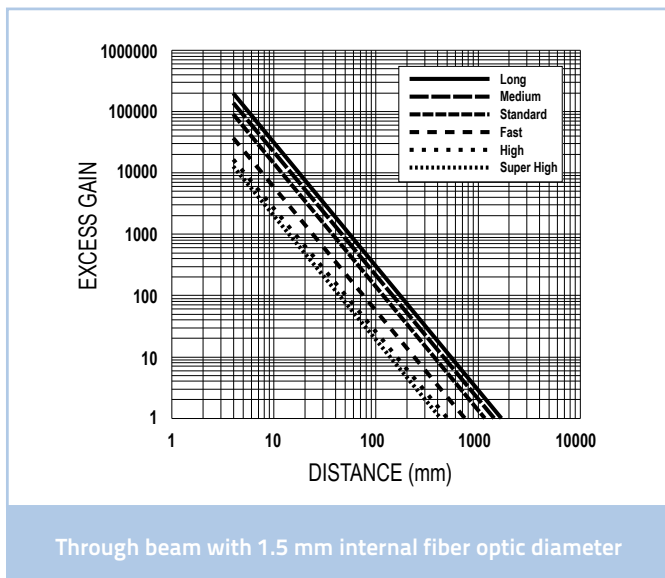

## S70-E2

	SUPER HIGH SPEED	HIGH SPEED	FAST	STANDARD	MEDIUM RANGE	LONG RANGE
Response Time	10 $\mu$ s	15 $\mu$ s	50 $\mu$ s	250 $\mu$ s	500 $\mu$ s	1 ms
Repeatability	5 $\mu$ s	5 $\mu$ s	12 $\mu$ s	50 $\mu$ s	80 $\mu$ s	165 $\mu$ s

## DETECTION DIAGRAM

### Detection area

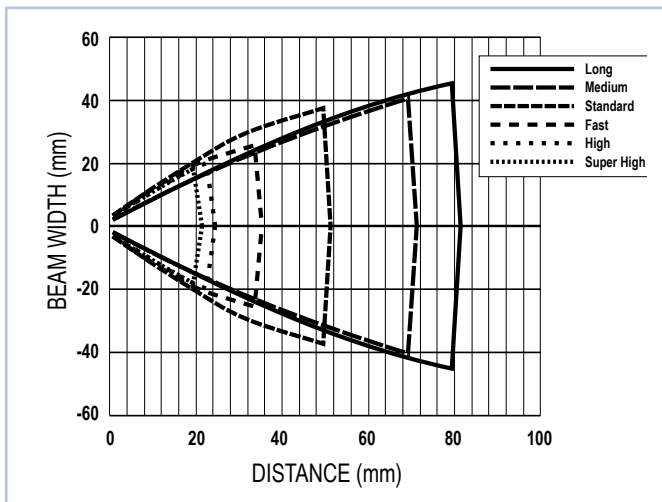

Through beam with 0.2 mm internal fiber optic diameter

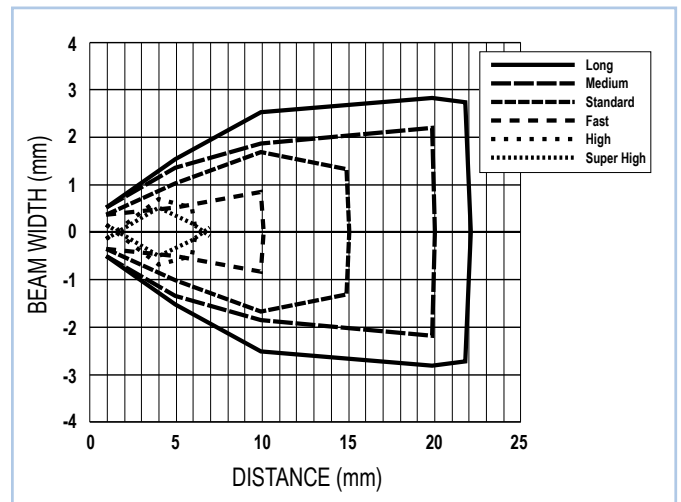

Diffuse proximity with 0.2 mm internal fiber optic diameter

### Detection area

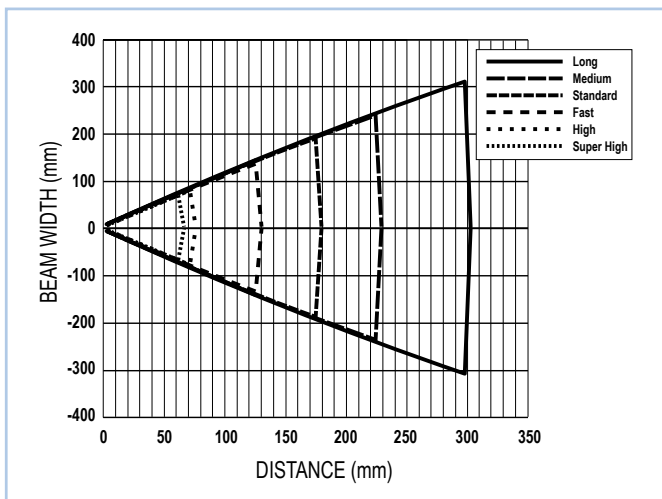

Through beam with 0.5 mm internal fiber optic diameter

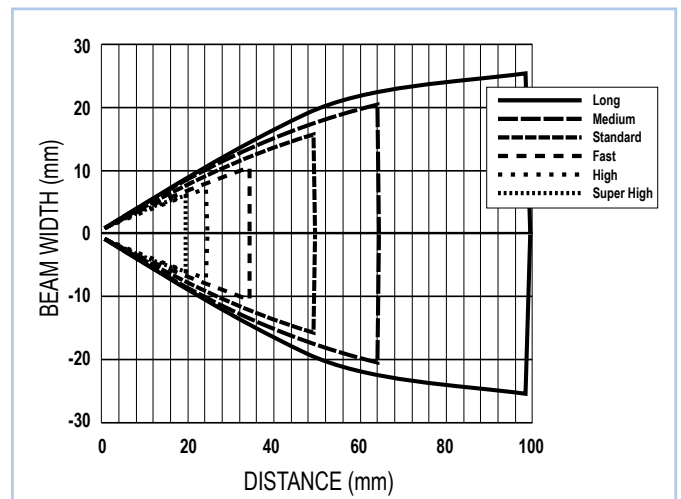

Diffuse proximity with 0.5 mm internal fiber optic diameter

## S70-E2

	SUPER HIGH SPEED	HIGH SPEED	FAST	STANDARD	MEDIUM RANGE	LONG RANGE
Response Time	10 $\mu$ s	15 $\mu$ s	50 $\mu$ s	250 $\mu$ s	500 $\mu$ s	1 ms
Repeatability	5 $\mu$ s	5 $\mu$ s	12 $\mu$ s	50 $\mu$ s	80 $\mu$ s	165 $\mu$ s

## DETECTION DIAGRAM

### Detection area

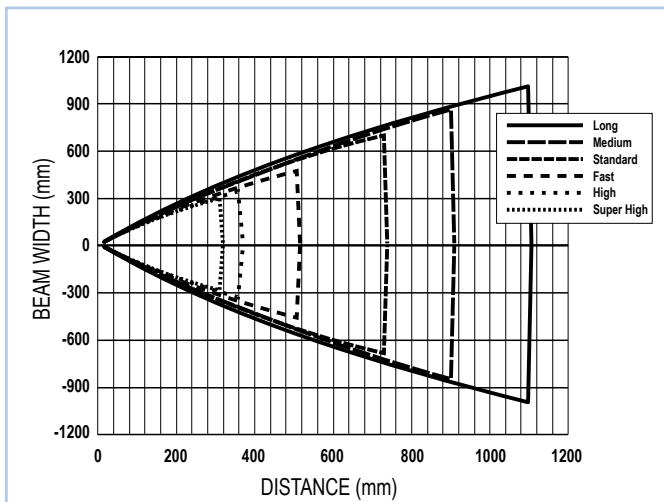

Through beam with 1 mm internal fiber optic diameter

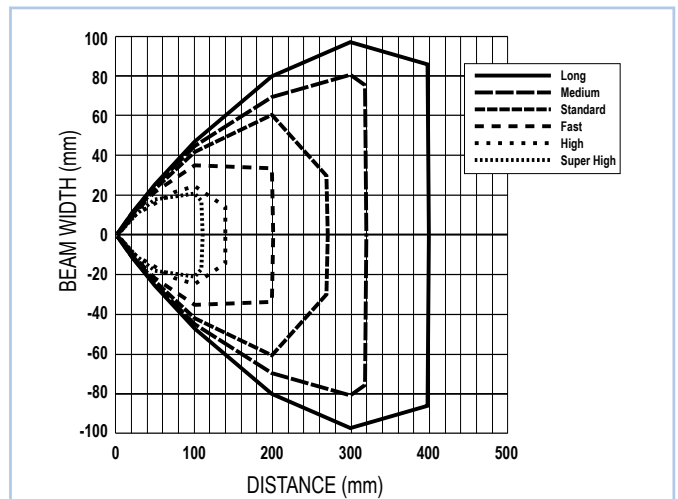

Diffuse proximity with 1 mm internal fiber optic diameter

### Detection area

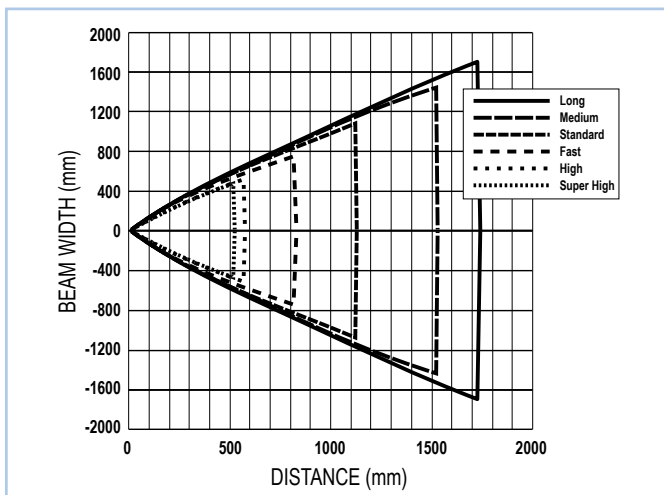

Through beam with 1.5 mm internal fiber optic diameter

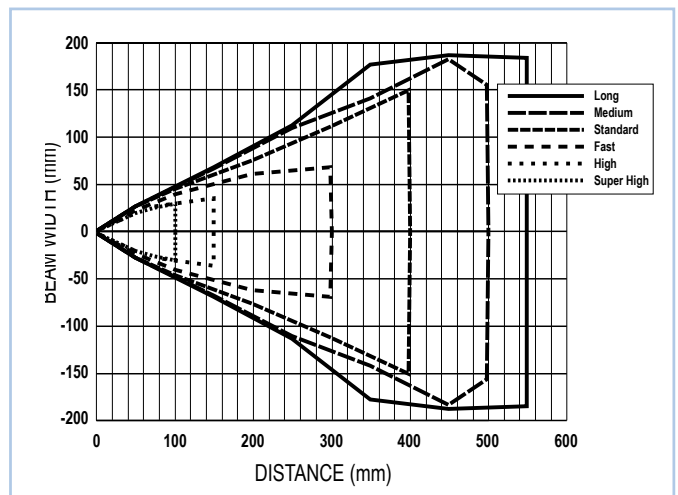

Diffuse proximity with 1.5 mm internal fiber optic diameter

## MODEL SELECTION AND ORDER INFORMATION

OPTIC FUNCTION	RESPONSE TIME	CONNECTION	OUTPUT	MODEL	ORDER No.
Optic fiber	200 $\mu$ s ... 5 ms	2 m Cable	NPN	S70-2-E1-N	950561000
			PNP	S70-2-E1-P	950561010
		M8 Connector	NPN	S70-5-E1-N	950561060
			PNP	S70-5-E1-P	950561020
	10 $\mu$ s ... 1 ms	M8 Connector	PNP, push-pull IO-Link	S70-5-E1-PZ	950561030
			NPN	S70-5-E2-N	950561040
			PNP	S70-5-E2-P	950561050

## ACCESSORIES

MODEL	DESCRIPTION	ORDER No.
CRD-5000	DIN rail mounting bracket	95ACC2790

CRD-5000

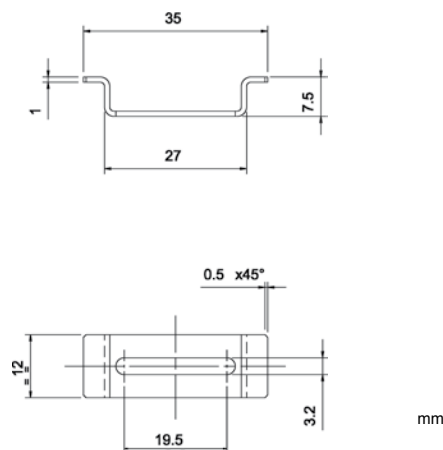

mm

## CABLES

TYPE	DESCRIPTION	LENGTH	MODEL	ORDER No.
Axial M8 Connector	4-pole, grey, P.V.C.	3 m	CS-B1-02-G-03	95A251420
		5 m	CS-B1-02-G-05	95A251430
		7 m	CS-B1-02-G-07	95A251440
		10 m	CS-B1-02-G-10	95A251480
	4-pole, P.U.R.	2 m	CS-B1-02-R-02	95A251620
		5 m	CS-B1-02-R-05	95A251640
Radial M8 Connector	4-pole, grey, P.V.C.	3 m	CS-B2-02-G-03	95A251450
		5 m	CS-B2-02-G-05	95A251460
		7 m	CS-B2-02-G-07	95A251470
		10 m	CS-B2-02-G-10	95A251530
	4-pole, P.U.R.	2 m	CS-B2-02-R-02	95A251630
		5 m	CS-B2-02-R-05	95A251650

Rev. 00, 07/2014



[www.datalogic.com](http://www.datalogic.com)

The company endeavours to continuously improve and renew its products; for this reason the technical data and contents of this catalogue may undergo variations without prior notice. For correct installation and use, the company can guarantee only the data indicated in the instruction manual supplied with the products.