

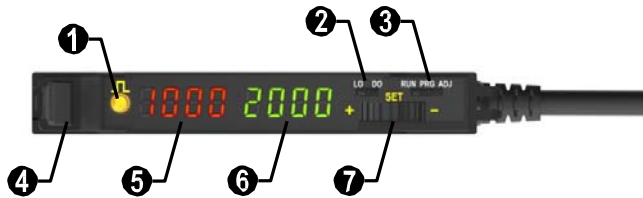

S70 Series

Advanced sensor with dual digital displays
for use with plastic and glass fiber optic assemblies

For complete technical information about this product, including dimensions, accessories, and specifications, see www.datalogic.com.



1	Output LED
2	LO/DO Switch
3	RUN/PRG/ADJ Mode Switch
4	Lever Action Fiber Clamp
5	Red Signal Level
6	Green Threshold
7	+/SET/- Navigation key

Figure 1



WARNING: Not to be used for personnel protection
Never use this device as a sensing device for personnel protection.
 Doing so could lead to serious injury or death. This device does not include the self-checking redundant circuitry necessary to allow its use in personnel safety applications.
 A sensor failure or malfunction can cause either an energized or de-energized sensor output condition.

Model	Outputs	Connector ¹
S70-2-E1-N	Single NPN	2 m cable, 4-wire
S70-2-E1-P	Single PNP	
S70-5-E1-N	Single NPN	Integral M8 Pico QD connector, 4-pin
S70-5-E1-P	Single PNP	
S70-5-E1-PZ	Dual outputs, 1 push-pull IO-Link and 1 PNP (complementary outputs)	
S70-5-E2-N	Single NPN	Integral M8 Pico QD connector, 4-pin
S70-5-E2-P	Single PNP	

CONNECTIONS

NPN Version

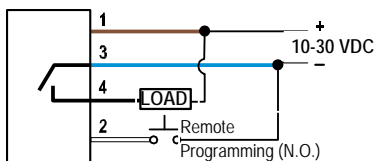

PNP Version

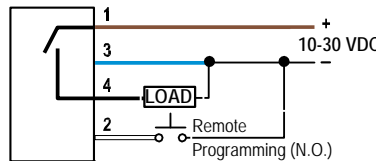

Key
 1 = Brown
 2 = White
 3 = Blue
 4 = Black

IO-Link Version

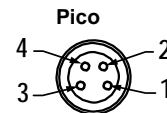
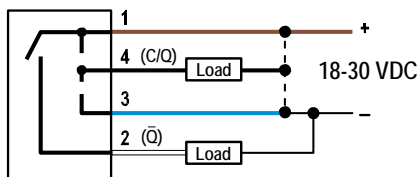

NOTE: Open lead wires must be connected to a terminal block.

¹ A model with a QD connector requires a mating cordset.

MOUNTING INSTRUCTIONS

Mount on a DIN Rail

1. Hook the DIN rail clip on the bottom of the S70 over the edge of the DIN rail (1).
2. Push the S70 up on the DIN rail (1).
3. Pivot the S70 onto the DIN rail, pressing until it snaps into place (2).

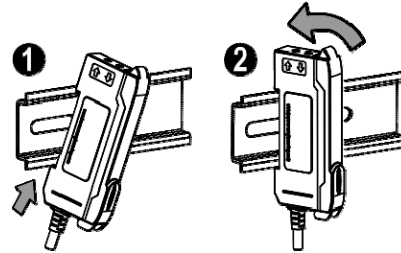

Remove from a DIN rail

1. Push the S70 up on the DIN rail (1).
2. Pivot the S70 away from the DIN rail and remove it (2).

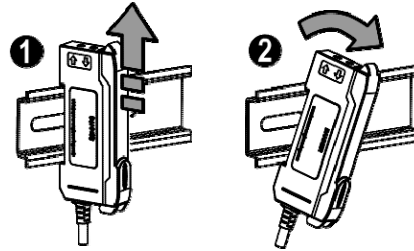

INSTALLING THE FIBERS

Follow these steps to install glass or plastic fibers.

1. Open the dust cover.
2. Move the fiber clamp forward to unlock it.
3. Insert the fiber(s) into the fiber port(s) until they stop.
4. Move the fiber clamp backward to lock the fiber(s).
5. Close the dust cover.

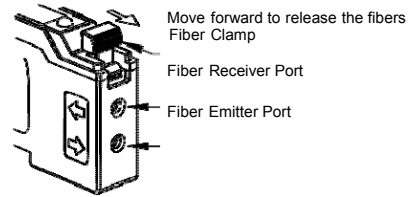

Fiber Adapters

NOTE: If a thin fiber with less than 2.2 mm outer diameter is used, install the fiber adapter provided with the fiber assembly to ensure a reliable fit in the fiber holder. Datalogic includes the adapters with all fiber assemblies.

Fiber Outer Diameter (mm)	Adapter Color
Ø 1.0	Black
Ø 1.3	Red
Ø 2.2	No adapter needed

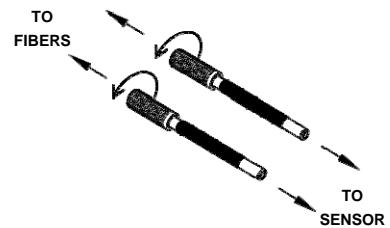

When connecting coaxial-type fiber assemblies to the amplifier, install the solid core fiber to the LED emitting port, and the multi-core fiber to the PD receiving port for most reliable detection.

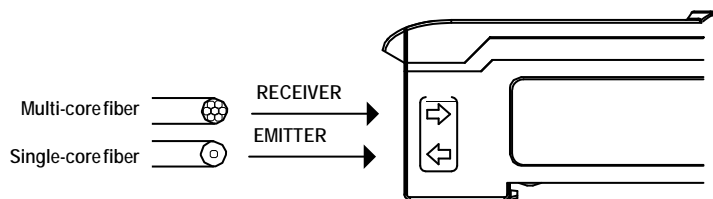

TOP PANEL INTERFACE

Opening the dust cover provides access to the top panel interface. The top panel interface consists of the RUN/PRG/ADJ mode switch, LO/DO switch, +/-SET/- Navigation key, dual red/green digital displays, and output LED.

RUN/PRG/ADJ Mode Switch

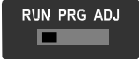

The RUN/PRG/ADJ mode switch puts the sensor in RUN, PRG (Program), or ADJ (Adjust) mode. RUN mode allows the sensor to operate normally and prevents unintentional programming changes via the +/-SET/- button. PRG mode allows the sensor to be programmed through the display driven programming menu (see **Program Mode** below). ADJ mode allows the user to perform Expert TEACH/SET methods and Manual Adjust (see **Adjust Mode** below).

LO/DO Switch



The LO/DO switch is used to select Light Operate or Dark Operate mode. In Light Operate mode, the output is ON when the sensing condition is above the threshold (for Window SET, the output is ON when the sensing condition is inside the window). In Dark Operate mode, the output is ON when the sensing condition is below the threshold (for Window SET, the output is ON when the sensing condition is outside the window).

+/-SET/- Navigation key

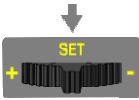

The +/-SET/- Navigation key is a 3-way button. The +/- positions are engaged by rocking the button left/ right. The SET position is engaged by clicking down the button while the rocker is in the middle position. All three button positions are used during PRG mode to navigate the display driven programming menu. During ADJ mode, SET is used to perform TEACH/SET methods and +/- are used to manually adjust the threshold(s). The Navigation key is disabled during RUN mode, except when using Window SET, see [Window SET](#).

Red/Green Digital Displays



During RUN and ADJ mode, the Red display shows the signal level and the Green display shows the threshold. During PRG mode, both displays are used to navigate the display driven programming menu.



Output LED

The output LED provides a visible indication when the output is activated.

Remote Input / IO-Link

For more information about how to perform TEACH/SET methods, to program the sensor remotely, or to interface with the sensor via IO-Link, see the www.datalogic.com.



Run Mode

Run mode allows the sensor to operate normally and prevents unintentional programming changes. The +/-SET/- Navigation key is disabled during RUN mode, except when using Window SET, see [Window SET](#).



Program Mode

Program (PRG) mode allows the following settings to be programmed in the S70:

S70-E1 Factory Default Settings:

Setting	Factory Default
Threshold	2026
TEACH Selection	Two-Point TEACH
Response Speed	Standard: 500 µs
Offset Percent	10%
Auto Thresholds	OFF
OFF Delay	0 (Disabled)
OFF One-Shot	0 (Disabled)
ON Delay	0 (Disabled)
ON One-Shot	0 (Disabled)
Display Readout	Numeric, ECO disabled, Normal Orientation
Gain Selection	Auto Gain

S70-E2 Factory Default Settings:

Setting	Factory Default
Threshold	2011
TEACH Selection	Two-Point TEACH
Response Speed	Standard: 250 µs
Offset Percent	10%
Auto Thresholds	OFF
OFF Delay	0 (Disabled)
OFF One-Shot	0 (Disabled)
ON Delay	0 (Disabled)
ON One-Shot	0 (Disabled)
Display Readout	Numeric, ECO disabled, Normal Orientation
Gain Selection	Auto Gain

PROGRAMMODE

Mode Switch to "PRG"



Menu List

Press and hold SET to exit choice list without saving

Menu Item	Navigation	Options
tcH SEL Click SET to enter choice list	+ (DISPLAY LOOP) -	2Pt tcH, dYn tcH, wind SET, Lt SET, dr SET, CAL SET
rESPSPd Click SET to enter choice list	+ (DISPLAY LOOP) -	xxx uS, xxx uS, xxx uS, xxx uS <small>for the value see "Technical Data" pag.17</small>
OFSt Pct Click SET to enter choice list	▼	min OFSt, 10 Pct, (+) or (-) to set value, 999 Pct
Auto thr Click SET to enter choice list	+ (DISPLAY LOOP) -	oFF, On
OFF dLY Click SET to enter choice list	▼	0 ms, (+) or (-) to set value, 9999 ms
OFF 1Sho Click SET to enter choice list	▼	0 ms, (+) or (-) to set value, 9999 ms
On dLY Click SET to enter choice list	▼	0 ms, (+) or (-) to set value, 9999 ms
On 1Sho Click SET to enter choice list	▼	0 ms, (+) or (-) to set value, 9999 ms
diSP rEAd Click SET to enter choice list	+ (DISPLAY LOOP) -	diSP 1234, diSP 123P, Eco 1234, Eco 123P, (display flips 180) diSP 1234, diSP 123P, Eco 1234, Eco 123P
GAin SEL Click SET to enter choice list	+ (DISPLAY LOOP) -	Auto GAin, Fixed Gain Set, 1234 Gn 1, 1234 Gn 2, ..., 1234 Gn 8
FctY dEF Click SET to enter choice list	+ (DISPLAY LOOP) -	no, yES

Navigation key

To scroll through menu lists: Press "+" or "-"
 To enter a choice list or to select and save: Click SET
 To exit a choice list without saving: Press and hold SET for 2 seconds

Click SET to select and save a choice in any list

Return to Menu List

on display represents a "w"

on display represents a "m"



ADJUST MODE

Sliding the RUN/PRG/ADJ mode switch to the ADJ position allows the user to perform Expert TEACH/SET methods and Manual Adjustment of the threshold(s).

Two-Point TEACH

- Establishes a single switching threshold
- Threshold can be adjusted using "+" and "-" Navigation key (Manual Adjust)

Two-Point TEACH is used when two conditions can be presented statically to the sensor. The sensor locates a single sensing threshold (the switch point) midway between the two taught conditions, with the Output ON condition on one side, and the Output OFF condition on the other (see Fig.2).

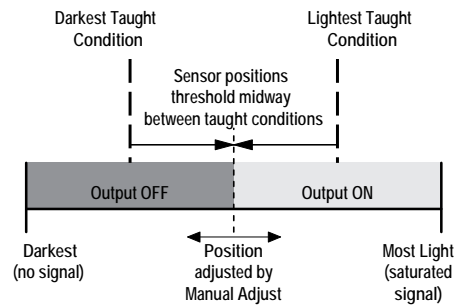

Figure 2. Two-Point TEACH (Light Operate shown)

The Output ON and OFF conditions can be reversed by using the LO/DO (Light Operate / Dark Operate) switch (see **LO/DO Switch** in [Top Panel Interface](#)).

Two-Point TEACH and Manual Adjust

Moves switching threshold value up or down to make adjustments

- Slide Mode switch to ADJ to enter Adjust mode
- Press "+" to increase; press "-" to decrease
 - GREEN display shows the switching threshold value
 - 2 seconds after adjustment, the GREEN display will flash 3 times to confirm
- Slide Mode switch to RUN to complete operation

Remember: Manual adjustments are disabled when Auto Thresholds are ON

Follow these steps to perform a Two-Point TEACH:

NOTE: TEACH Selection must be programmed to **2Pt tcH** (see [Program Mode](#))



1. Enter Adjust mode.

Method	Action	Result
SET Button ²	Set the Mode switch to ADJ.	Display: Red - Signal Level; Green - Threshold
Remote Input ³	No action is required; sensor is ready for the Two-Point TEACH method	1234 2000



² SET Button: 0.04 seconds ≤ "Click" ≤ 0.8 seconds

³ Remote Input: 0.04 seconds ≤ T ≤ 0.8 seconds

2. Teach the first condition.

Method	Action	Result
SET Button	a. Present the first condition. b. Click the SET Navigation key	Display: Flashes "2Pt tch" then holds on "1234 2nd" 
Remote Input	a. Present the first condition b. Single-pulse the remote input	

3. Teach the second condition.

Method	Action	Result
SET Button	a. Present the second condition. b. Click the SET Navigation key.	TEACH Accepted Displays alternate "PASS" and % Minimum Difference ⁴ ; Sensor returns to Adjust mode
Remote Input	a. Present the second condition. b. Single-pulse the remote input.	 TEACH Not Accepted Displays alternate "FAIL" and % Minimum Difference ⁴ ; Sensor returns to Adjust mode
		

4. Return to Run mode.

Method	Action	Result
SET Button	Move the Mode switch to RUN	Display: Red - Signal Level; Green - Threshold
Remote Input	No action is required; sensor returns to RUN mode automatically	

Dynamic TEACH

- Teaches on-the-fly
- Establishes a single switching threshold
- Threshold can be adjusted using "+" and "-" Navigation key (Manual Adjust)

Dynamic TEACH is best used when a machine or process may not be stopped for teaching. The sensor learns during actual sensing conditions, taking multiple samples of the light and dark conditions and automatically setting the threshold at the optimum level (see Fig.3).

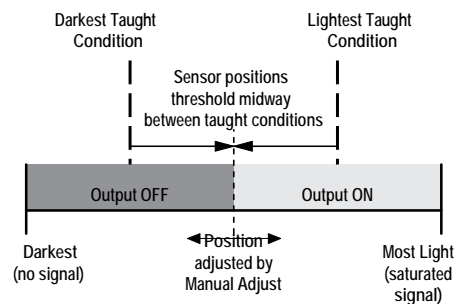

Figure 3. Dynamic TEACH (Light Operate shown)

The output ON and OFF conditions can be reversed using the LO/DO switch (see **LO/DO Switch** in [Top Panel Interface](#)).

⁴ See [Troubleshooting](#) on page 16 for more explanation of the % Minimum Difference displayed after the Two-Point TEACH method

Dynamic TEACH and Manual Adjust

Moves switching threshold value up or down to make adjustments



- Slide Mode switch to ADJ to enter Adjust mode
- Press "+" to increase; press "-" to decrease
 - GREEN display shows the switching threshold value
 - 2 seconds after adjustment, GREEN display will flash 3 times to confirm
- Slide Mode switch to RUN to complete operation

Remember: Manual adjustments are disabled when Auto Thresholds are ON



Follow these steps to perform a **Dynamic TEACH**:

NOTE: TEACH Selection must be programmed to **dYn tch** (see [Program Mode](#))

1. Enter Adjust Mode.

Method	Action	Result
SET Button ⁵	Set Mode switch to ADJ 	Display: Red - Signal Level; Green - Threshold 
Remote Input ⁶	No action required; sensor is ready for Dynamic TEACH method	

2. Enter Dynamic TEACH.

Method	Action	Result
SET Button	Click the SET Navigation key 	Display: Flashes "dYn tch" then holds on "1234 dYn" 
Remote Input	Single-pulse remote input 	





3. Present ON and OFF Conditions.

Method	Action	Result
SET Button	Present ON and OFF conditions	Display: Red - Signal Level; Green - Threshold 
Remote Input	Present ON and OFF conditions	

⁵ SET Button: 0.04 seconds ≤ "Click" ≤ 0.8 seconds

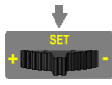
⁶ Remote Input: 0.04 seconds ≤ T ≤ 0.8 seconds

4. Exit Dynamic TEACH.

Method	Action	Result
SET Button	Click the SET Navigation key 	TEACH Accepted Displays alternate "PASS" with % Minimum Difference, Sensor returns to Adjust mode 
Remote Input	Single-pulse remote input 	TEACH Not Accepted Displays alternate "FAIL" with % Minimum Difference, Sensor returns to Adjust mode 

5. Return to RUN Mode.

Method	Action	Result
SET Button	Move Mode switch to RUN 	Display: Red - Signal Level; Green - Threshold 
Remote Input	No action required; sensor returns to RUN mode automatically	

Window SET

- Sets window thresholds that extend a programmable % offset above and below the presented condition
- All other conditions (lighter or darker) cause the output to change state
- Sensing window center can be adjusted using "+" and "-" Navigation key (Manual Adjust)
- Recommended for applications where a product may not always appear in the same place, or when other signals may appear
- See Program Mode in the user's manual for programming the Offset Percent setting (to increase/decrease the window size)

A single sensing condition is presented, and the sensor positions window thresholds a programmable % offset above and below the presented condition. In LO mode, Window SET designates a sensing window with the Output ON condition inside the window, and the Output OFF conditions outside the window (see Fig.4).

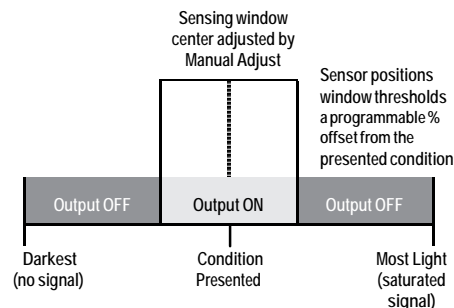

Figure 4. Window SET (Light Operate shown)

Output ON and OFF conditions can be reversed using the LO/DO switch (see **LO/DO Switch** in [Top Panel Interface](#)).

⁷ See [Troubleshooting](#) on page 16 for more explanation of the % Minimum difference displayed after the Dynamic TEACH method.

Window SET and Manual Adjust

Moves sensing window center value up or down to make adjustments



- Slide Mode switch to ADJ to enter Adjust mode
- Press "+" to increase; press "-" to decrease
 - GREEN display shows the sensing window center value
 - 2 seconds after adjustment, the GREEN display will flash 3 times to confirm
- Slide Mode switch to RUN to complete operation

Remember: Manual adjustments are disabled when Auto Thresholds are ON





Follow these steps to perform a Window SET:

Note: TEACH Selection must be programmed to *wind SET* (see [Program Mode](#))

1. Enter Adjust Mode

Method	Action	Result
SET Button ⁸	Set Mode switch to ADJ 	Display: Red - Signal Level; Green - Threshold
Remote Input ⁹	No action required; sensor is ready for Window SET method	

2. SET Sensing Condition



Method	Action	Result
SET Button	<ul style="list-style-type: none"> • Present sensing condition • Click the SET Navigation key  	<p>Threshold Condition Accepted</p> <p>Displays read "wInd SET" then alternate "PASS" with % Offset¹⁰; Sensor returns to Adjust mode</p>  <p>Threshold Condition Not Accepted</p> <p>Displays read "wInd SET" then alternate "FAIL" with minimum % Offset¹⁰ for sensing condition; Sensor returns to Adjust mode</p> 
Remote Input	<ul style="list-style-type: none"> • Present sensing condition • Single-pulse the remote input  	

⁸ SET Button: 0.04 seconds ≤ "Click" ≤ 0.8 seconds

⁹ Remote Input: 0.04 seconds ≤ T ≤ 0.8 seconds

¹⁰ See [Troubleshooting](#) on page 16 for more explanation of the % Offset displayed after the Window SET method.

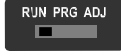
3. Return to RUN Mode

Method	Action	Result
SET Button	Move Mode switch to Run 	Display: Red - Signal Level; Green - Window Center (see Figure 5 for instructions on how to display upper and lower thresholds)
Remote Input	No action required; sensor returns to Run mode automatically	

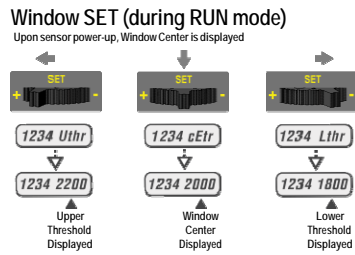

Figure 5. Upper and Lower Thresholds

Light SET

- Sets a threshold a programmable % offset below the presented condition
- Changes output state on any condition darker than the threshold condition
- Threshold can be adjusted using "+" and "-" Navigation key (Manual Adjust)
- Recommended for applications where only one condition is known, for example a stable light background with varying darker targets
- See [Program Mode](#) for programming the Offset Percent setting

A single sensing condition is presented, and the sensor positions a threshold a programmable % offset below the presented condition. When a condition darker than the threshold is sensed, the output either turns ON or OFF, depending on the LO/DO switch setting (see **LO/DO Switch** in [Top Panel Interface](#)).

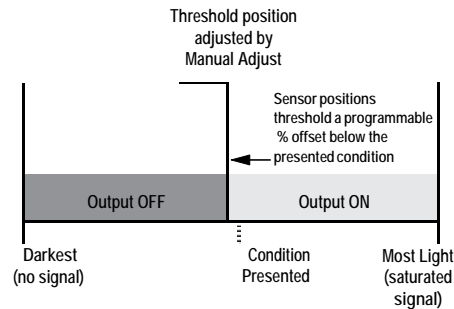

Figure 6. Light SET (Light Operate shown)

Light SET and Manual Adjust

Moves switching threshold value up or down to make adjustments



- Slide Mode switch to ADJ to enter Adjust mode
- Press "+" to increase; press "-" to decrease
 - GREEN display shows the switching threshold value
 - 2 seconds after adjustment, the GREEN display will flash 3 times to confirm
- Slide Mode switch to RUN to complete operation

Remember: Manual adjustments are disabled when Auto Thresholds are ON

Follow these steps to perform a Light SET:

Note: TEACH Selection must be programmed to Lt SET (see [Program Mode](#))

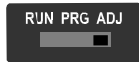



1. Enter Adjust Mode

Method	Action	Result
SET Button ¹¹	Set Mode switch to ADJ 	Display: Red - Signal Level; Green - Threshold
Remote Input ¹²	No action is required; sensor is ready for Light SET method	

¹¹ SET Button: 0.04 seconds ≤ "Click" ≤ 0.8 seconds

¹² Remote Input: 0.04 seconds ≤ T ≤ 0.8 seconds

2. SET Sensing Condition

Method	Action	Result
SET Button	<ul style="list-style-type: none"> Present sensing condition Click the SET Navigation key 	<p>Threshold Condition Accepted</p> <p>Displays read "Lt SET" then alternate "PASS" with % Offset¹³; Sensor returns to Adjust mode</p> 
Remote Input	<ul style="list-style-type: none"> Present sensing condition Single-pulse the remote input 	<p>Threshold Condition Not Accepted</p> <p>Displays read "Lt SET" then alternate "FAIL" with minimum % Offset¹³ for sensing condition; Sensor returns to Adjust mode</p> 

3. Return to RUN Mode

Method	Action	Result
SET Button	Move Mode switch to RUN	Display: Red - Signal Level; Green - Threshold 
Remote Input	No action required; sensor returns to RUN mode automatically	

Dark SET

- Sets a threshold a programmable % offset above the presented condition
- Any condition lighter than the threshold condition causes the output to change state
- Threshold can be adjusted using "+" and "-" Navigation key (Manual Adjust)
- Recommended for applications where only one condition is known, for example a stable dark background with varying lighter targets
- See [Program Mode](#) for programming the Offset Percent setting

NOTE: Offset Percent *MUST* be programmed to **Minimum Offset** to accept conditions of no signal (0 counts).

A single sensing condition is presented, and the sensor positions a threshold a programmable % offset above the presented condition. When a condition lighter than the threshold is sensed, the output either turns ON or OFF, depending on the LO/DO switch setting (see **LO/DO Switch** in [Top Panel Interface](#)).

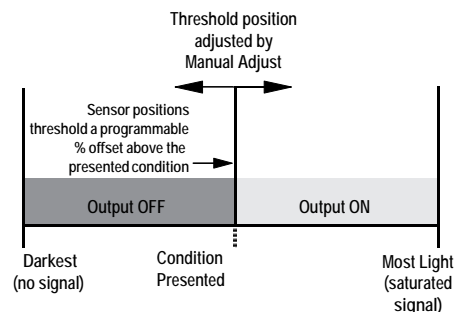

Figure 7. Dark SET (Light Operate shown)

¹³See [Troubleshooting](#) for more explanation of the % Offset displayed after the Light SET method.

Dark SET and Manual Adjust

Moves switching threshold value up or down to make adjustments



- Slide Mode switch to ADJ to enter Adjust mode
- Press "+" to increase; press "-" to decrease
 - GREEN display shows the switching threshold value
 - 2 seconds after adjustment, the GREEN display will flash 3 times to confirm
- Slide Mode switch to RUN to complete operation

Remember: Manual adjustments are disabled when Auto Thresholds are ON



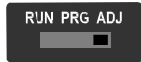

Follow these steps to perform a Dark SET:

Note: TEACH Selection must be programmed to *dr SET* (see [Program Mode](#))

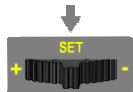

1. Enter Adjust Mode.

Method	Action	Result
SET Button ¹⁴	Set Mode switch to ADJ 	Display: Red - Signal Level; Green - Threshold
Remote Input ¹⁵	No action required; sensor is ready for Dark SET method	

2. SET Sensing Condition.

Method	Action	Result
SET Button	<ul style="list-style-type: none"> • Present sensing condition • Click the SET Navigation key 	<p>Threshold Condition Accepted</p> <p>Displays read "dr SET" then alternate "PASS" with % Offset¹⁶; Sensor returns to Adjust mode</p>
Remote Input	<ul style="list-style-type: none"> • Present sensing condition • Single-pulse the remote input 	<p></p> <p>Threshold Condition Not Accepted</p> <p>Displays read "dr SET" then alternate "FAIL" with minimum % Offset¹⁶ for sensing condition; Sensor returns to Adjust mode</p> <p></p>

3. Return to RUN Mode.

Method	Action	Result
SET Button	Move Mode switch to RUN 	Display: Red - Signal Level; Green - Threshold
Remote Input	No action required; sensor returns to RUN mode automatically	

¹⁴ SET Button: 0.04 seconds ≤ "Click" ≤ 0.8 seconds

¹⁵ Remote Input: 0.04 seconds ≤ T ≤ 0.8 seconds

¹⁶ See [Troubleshooting](#) on page 16 for more explanation of the % Offset displayed after the Dark SET method.

Calibration SET

- Sets a threshold exactly at the presented condition
- Threshold can be adjusted using "+" and "-" Navigation key (Manual Adjust)

A single sensing condition is presented, and the sensor positions a threshold exactly at the presented condition. When a condition lighter than the threshold is sensed, the output either turns ON or OFF, depending on the LO/DO switch setting (see **LO/DO Switch** in [Top Panel Interface](#)).

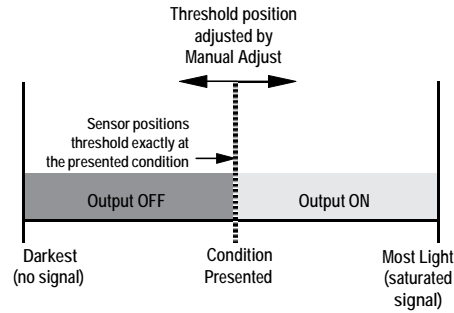

Figure 8. Calibration SET (Light Operate shown)

Calibration SET and Manual Adjust

Moves switching threshold value up or down to make adjustments



- Slide Mode switch to ADJ to enter Adjust mode
- Press "+" to increase; press "-" to decrease
 - GREEN display shows the switching threshold value
 - 2 seconds after adjustment, the GREEN display will flash 3 times to confirm
- Slide Mode switch to RUN to complete operation

Remember: Auto Thresholding is automatically disabled in Calibration SET

Follow these steps to perform a Calibration SET:

Note: TEACH Selection must be programmed to CAL SET (see [Program Mode](#))







1. Enter Adjust Mode

Method	Action	Result
SET Button ¹⁷	<ul style="list-style-type: none"> • Set Mode switch to ADJ 	Display: Red - Signal Level; Green - Threshold
Remote Input ¹⁸	No action required; sensor is ready for Calibration SET method	

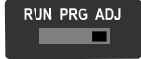

¹⁷ SET Button: 0.04 seconds ≤ "Click" ≤ 0.8 seconds

¹⁸ Remote Input: 0.04 seconds ≤ T ≤ 0.8 seconds

2. SET Sensing Condition

Method	Action	Result
SET Button	<ul style="list-style-type: none"> Present sensing condition Click the SET Navigation key 	<p>Threshold Condition Accepted Displays read "cAL SET" then flashes "PASS"; Sensor returns to Adjust mode</p>
Remote Input	<ul style="list-style-type: none"> Present sensing condition Single-pulse the remote input 	  <p>Threshold Condition Unacceptable Displays read "cAL SET" then flashes "FAIL"; Sensor returns to Adjust mode</p>  

1. Return to RUN Mode.

Method	Action	Result
SET Button	Move Mode switch to RUN 	Display: Red - Signal Level; Green - Threshold
Remote Input	No action required; sensor returns to RUN mode automatically	

IO-Link Interface

IO-Link is a point-to-point communication link between a master device and sensor. It can be used to automatically parameterize sensors and transmit process data. For the latest IO-Link protocol and specifications, please visit the web site at www.io-link.com.

The IO-Link IODD package is available on the Datalogic Website at www.datalogic.com.

Troubleshooting

Manual Adjustments Disabled

Manual adjustments are disabled when Auto Thresholds are ON. If a manual adjustment is attempted while Auto Thresholds are ON, the Green display will flash .

Percent Minimum Difference after TEACH

The Two-Point and Dynamic TEACH methods will flash a % minimum difference on the displays after a PASS or FAIL.

Value	PASS/FAIL	Description
0 to 99%	FAIL	The difference of the taught conditions does not meet the required minimum
100 to 300%	PASS	The difference of the taught conditions just meets/exceeds the required minimum, minor sensing variables may affect sensing reliability
300 to 600%	PASS	The difference of the taught conditions sufficiently exceeds the required minimum, minor sensing variables will not affect sensing reliability
600% +	PASS	The difference of the taught conditions greatly exceeds the required minimum, very stable operation



Percent Offset after SET

The Window, Dark, and Light SET methods will flash a % offset on the displays after a PASS or FAIL.

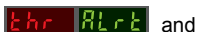

SET Result	% Offset Meaning
PASS (with % Offset)	Displays the % offset used for the SET method
FAIL (with % Offset)	Displays the minimum required % offset necessary to PASS the SET method
FAIL (without % Offset)	Presented condition cannot be used for the SET method

Threshold Alert or Threshold Error

Severe contamination/changes in the taught condition can prevent the Auto Thresholds algorithm from optimizing the threshold(s).

State	Display	Description	Corrective Action
Threshold Alert	Alternates  and 	The threshold(s) cannot be optimized, but the sensor's output will still continue to function	Cleaning/correcting the sensing environment and/or a re-teach of the sensor is highly recommended
Threshold Error		The threshold(s) cannot be optimized, and the sensor's output will stop functioning	Cleaning/correcting the sensing environment and/or a re-teach of the sensor is required

TECHNICAL DATA

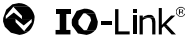
	S70-x-E1	S70-x-E2
Sensing Beam:	660 nm visible red	635 nm visible red
Supply Voltage:	NPN/PNP models: 10 ... 30 VDC Class 2 (10% max ripple) IO-Link models: 18 ... 30 V dc (10% max ripple)	
Power and Current Consumption (exclusive of load):	Standard display mode: 960 mW, Current consumption < 40 mA at 24 VDC ECO display mode: 720 mW, Current consumption < 30 mA at 24 VDC	
Supply Protection Circuitry:	Protected against reverse polarity, overvoltage, and transient voltages	
Delay at Power Up:	500 milliseconds max.; outputs do not conduct during this time	
Output Configuration:	NPN/PNP models: 1 current sinking (NPN) or 1 current sourcing (PNP) output, depending on model	
	IO-Link: 1 push-pull and 1 PNP (complementary outputs)	-
Output Rating:	100 mA max. load (derate 1 mA per °C above 30 °C) OFF-state leakage current: NPN/PNP models: < 5 µA at 30 VDC; ON-state saturation voltage: NPN: < 1.5 V; PNP / IO-Link: < 2 V	
	IO-Link: < 50 µA at 30 VDC	-
Output Protection:	Protected against output short-circuit, continuous overload, transient over-voltages, and false pulse on power up	
Output Response Time:	High Speed: 200 µs; Standard: 500 µs; Long Range: 2 ms; Extra Long Range: 5 ms	Super High Speed: 10 µs High Speed: 15 µs Fast: 50 µs Standard: 250 µs Medium Range: 500 µs Long Range: 1000 µs
Repeatability:	High Speed: 66 µs, Standard/Long Range: 100 µs Extra Long Range: 100 µs	Super High Speed: 5 µs High Speed: 5 µs Fast: 12 µs Standard: 50 µs Medium Range: 80 µs Long Range: 165 µs
Construction:	Black ABS / Polycarbonate alloy (UL94 V-0 rated) housing, clear polycarbonate cover	
Environmental Rating:	IEC IP50, NEMA 1	
Operating Temperature:	-10 °C ... +55 °C	
Storage Temperature:	-20 °C... +85 °C	
Humidity:	90% at +60 °C maximum relative humidity (non- condensing)	
IO-Link Interface:	Supports Smart Sensor Profile: Yes Baud Rate: 38,400 bps (COM2) Process Data Width: 16 bits IODD files: Provide all programming options of top panel interface, plus additional functionality	
Certifications:	 	
		-

OVERALL DIMENSIONS

CABLE VERSION

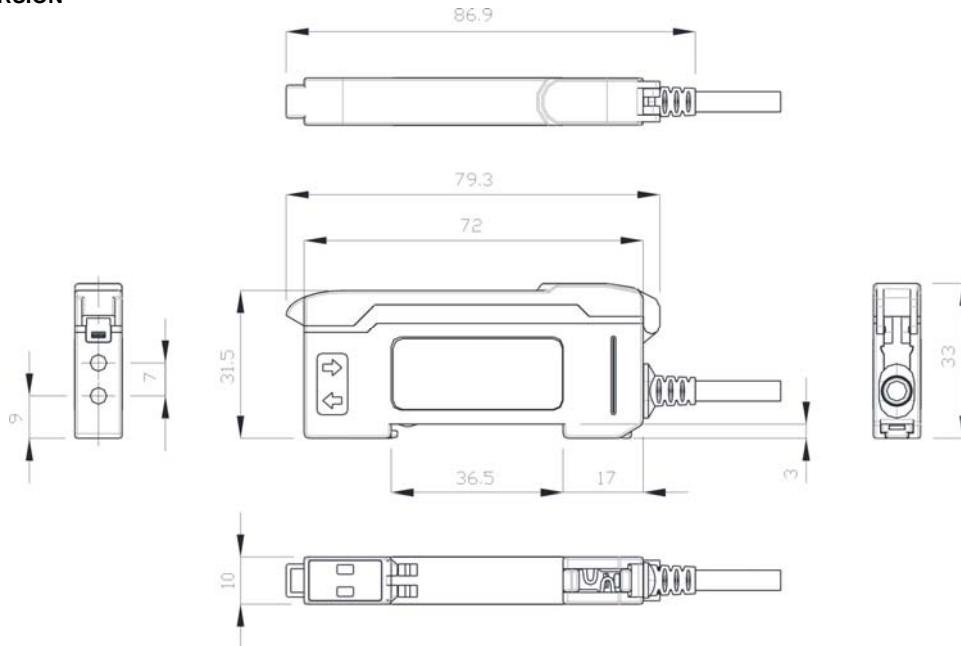

CONNECTOR VERSION

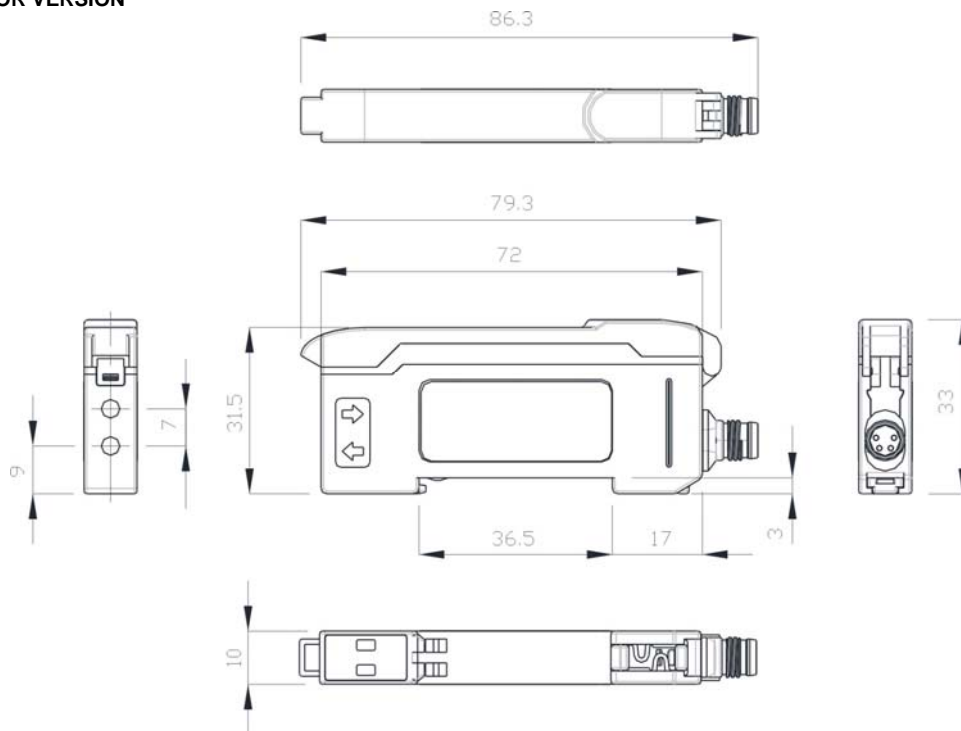

Dimensions in mm

DATALOGIC AUTOMATION srl
Via Lavino 265 - 40050 Monte S. Pietro - Bologna - Italy
Tel: +39 051 6765611 Fax: +39 051 6759324
www.datalogic.com

DATALOGIC AUTOMATION reserves the right to make modifications and improvements without prior notification

821002591 Rev.A