

HOST INTERFACE MODULES

INSTRUCTION MANUAL

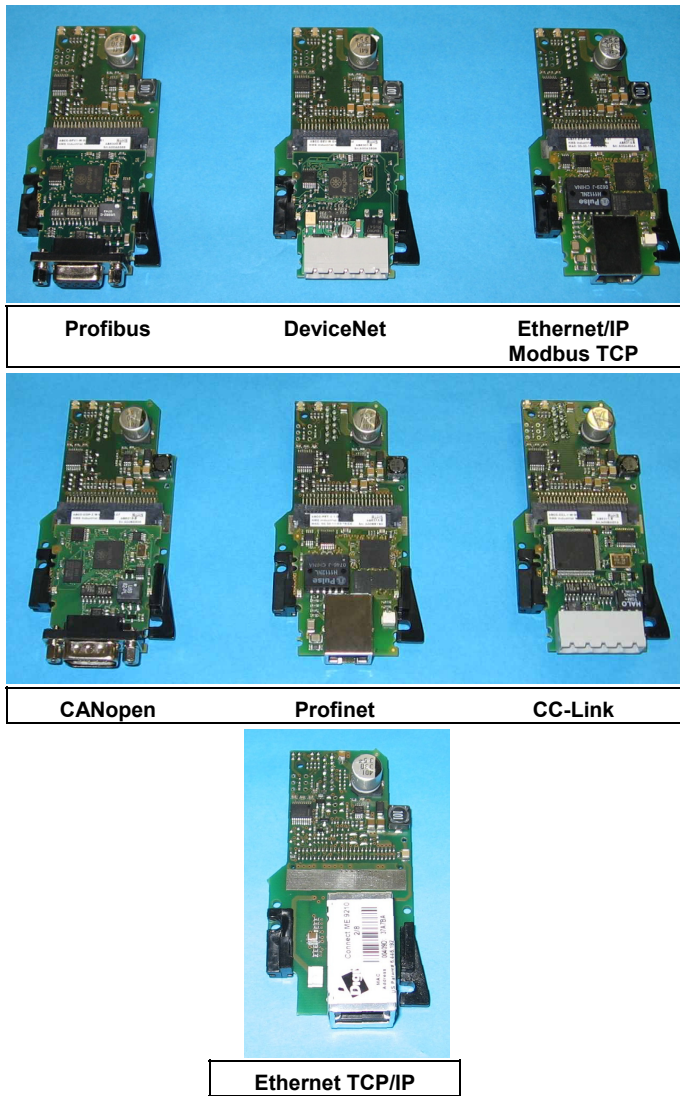

Figure 1 – General View

DESCRIPTION

The Host Interface Modules are accessories for the CBX500 connection boxes. They provide Stand Alone or Master Scanner connection to a network. The following types are available:

BM200	Ethernet TCP/IP Module	93ACC1851
BM210	Ethernet TCP/IP IP65 Module	93ACC1852
BM300	Profibus Module	93ACC1810
BM310	Profibus IP65 Module	93ACC1811
BM400	DeviceNet IP65 Module	93ACC1814
BM500	Ethernet/IP Module	93ACC1812
BM510	Ethernet/IP IP65 Module	93ACC1813
BM520	Ethernet/IP IP54 Module	93ACC1840
BM600	CANopen Module	93ACC1815
BM700	Profinet Module	93ACC1816
BM710	Profinet IP65 Module	93ACC1886
BM1100	CC-Link Module	93ACC1845
BM1200	Modbus TCP Module	93ACC1848
BM1210	Modbus TCP IP65 Module	93ACC1849



NOTE
Not all readers support all CBX accessories. Compatibility between the accessories and your reader depends on the reading device application software. See the "Accessories" paragraph in your reading device Reference Manual for the list of supported CBX Series accessories.

Technical Features	
Operating Temperature	0° to 50 °C (+32° to 122 °F)
Storage Temperature	-20° to 70 °C (-4° to 158 °F)
Humidity max.	90% non condensing

INSTALLATION



CAUTION
Power must be off before starting this procedure.
Communication between the Host and node must be shut down until the scanner/reader parameter modifications are completely saved in permanent memory.

1. Install the BM100 Backup Module into the CBX according to the BM100 Installation Instructions.
2. Install the Host Interface Module into the CBX as follows:
 - a. Place the Host Interface Module over the locator pins to correctly align it over the connector.
 - b. Press down on the module until the connector is correctly seated.
 - c. Mount the three module fixing screws.
 - d. Mount the Front Panel using the two fixing screws.

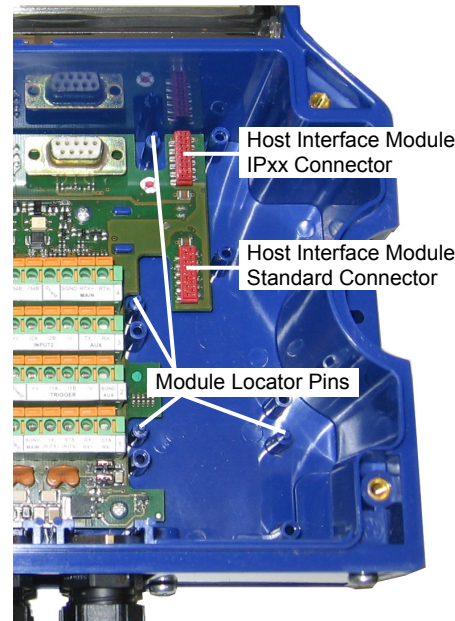

Figure 2 – CBX500 Host Interface Module Mounting References

3. Set the BM100 Backup Module rotary switch settings according to the network type. For details, see the BM100 Instruction Manual.
4. Power up the system.
5. Connect the configuration PC to the reader through the CBX (9-pin) Aux port connector and launch the configuration program (Genius™ or VisiSet™).
6. Get the reader configuration and configure the network parameters according to your application. For details, see the reader Help On-Line parameter guide.
7. Save the configuration to permanent scanner/reader memory.
8. Get the scanner configuration to verify the new values.
9. *** Configure the new node on the Host network.**
10. Connect the network cable to the CBX.
11. Start network communication.

* See the **Network Configuration** chapter in the **DAD Driver Reference Manual** for special notes and rules on Host configuration files.



NOTE
To change a node address on an existing network, it is not necessary to unplug the cable, however you must shut down communication between the Host and node. Follow the procedure above starting from step 3.

STANDARD MOUNTING POSITION

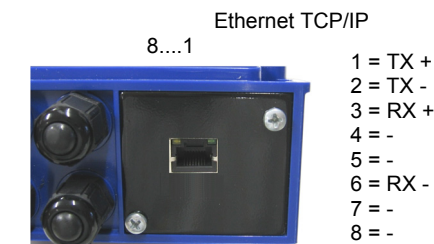
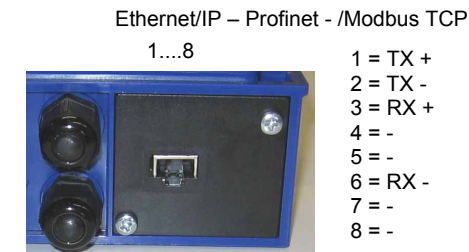
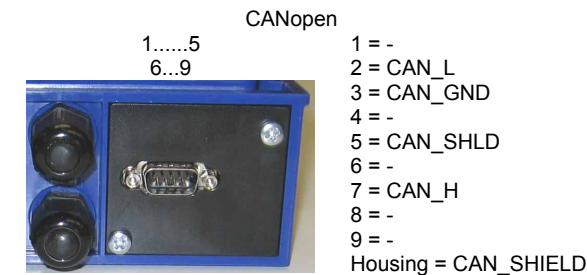
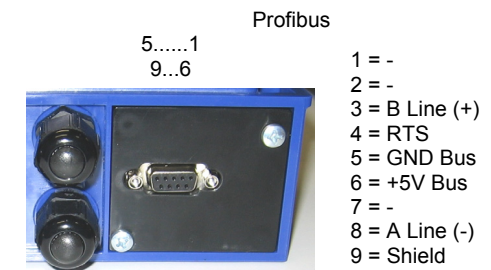
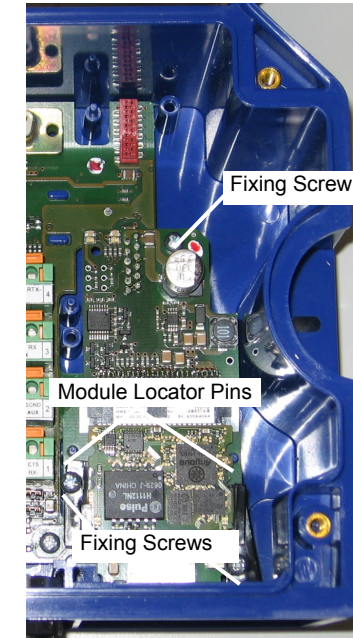

NOTE: Remove protective film

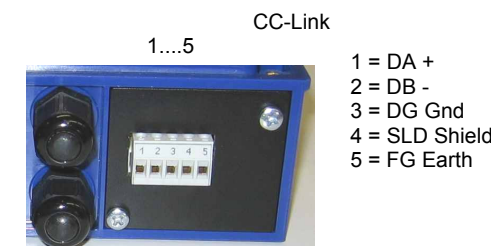

IP MOUNTING POSITION

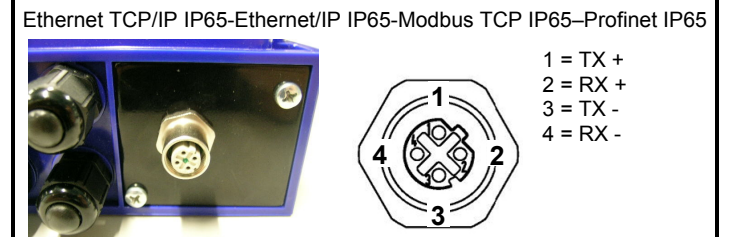
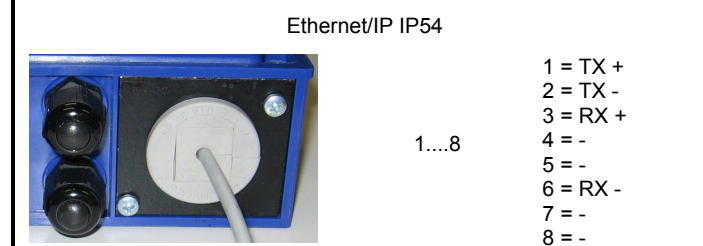
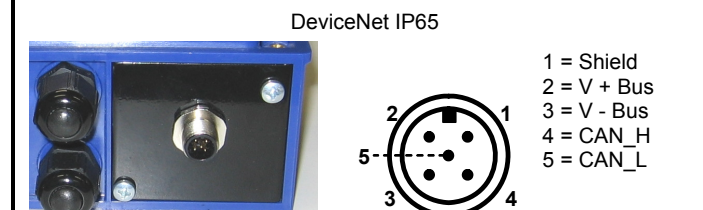
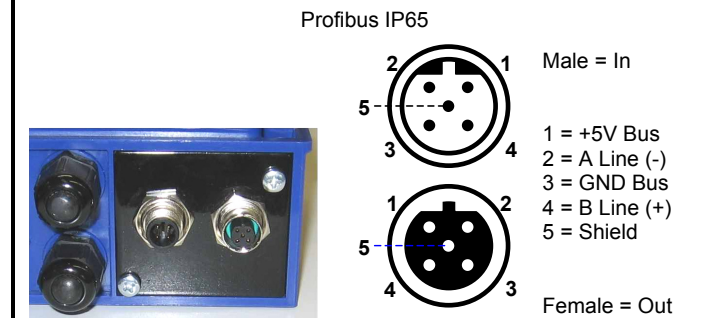
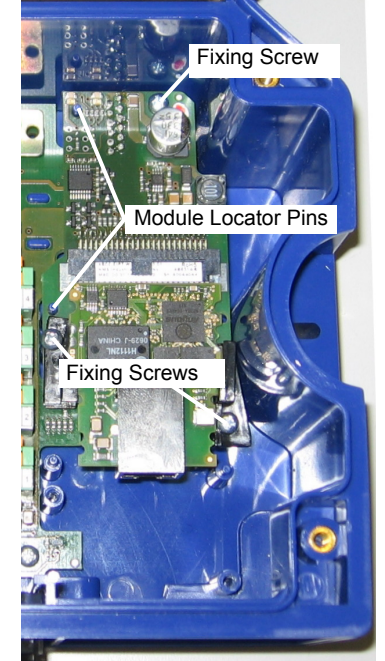

IP ratings are valid only when cables with mating connectors or connector plugs are correctly installed.

Only connect Ethernet and dataport connections to a network which has routing only within the plant or building and no routing outside the plant or building.

Profibus IP65 Installation

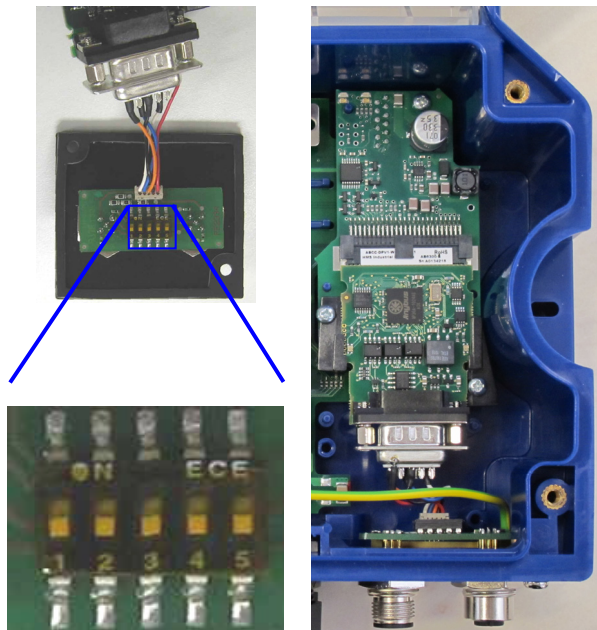

**Figure 3 –
Bus Termination Switches
Profibus Module IP65 Mounting**

Bus termination switches are located on the back of the connector panel for the Profibus IP65 connection.

ONLY the last slave node on the Profibus network must be terminated and this can be done in one of two ways:

- Connect a standard Profibus terminator onto the M12 Female connector, (i.e. Lumberg "SAC-5P-M12MS PB TR" terminator). In this case ALL the bus termination switches must be OFF.
- If no standard Profibus terminator is used, set ALL the bus termination switches to ON. In this case install a connector plug onto the M12 Female connector to maintain the IP rating.

ALL Profibus slave nodes other than the last one, must have ALL the switches set to OFF.

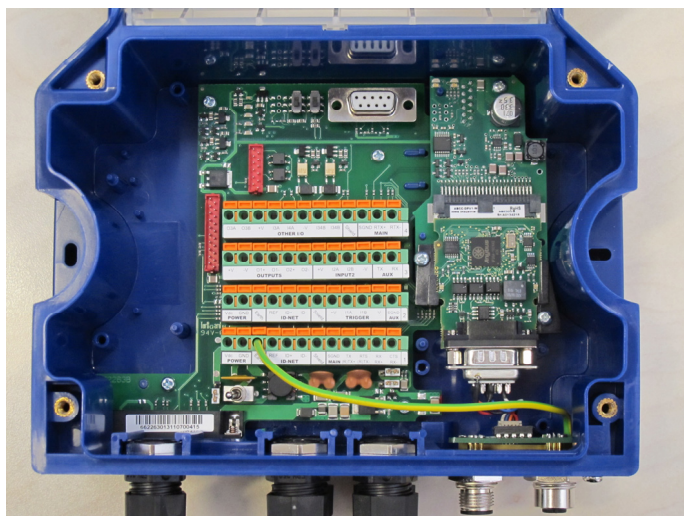

DeviceNet IP65 Installation



**Figure 4 –
DeviceNet Module
IP65 Mounting**

**Ethernet/IP IP65 -
Modbus TCP IP65 Installation**



**Figure 5 –
Ethernet/IP Module –
Modbus TCP Module
IP65 Mounting**

Ethernet TCP/IP IP65 Installation

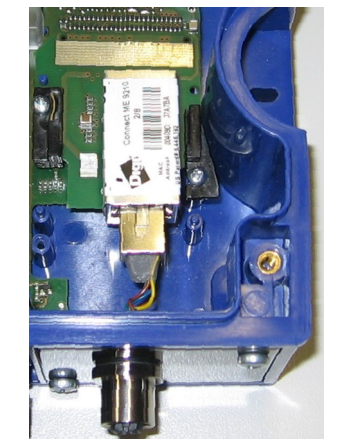

**Figure 6 –
Ethernet TCP/IP Module –
IP65 Mounting**

Ethernet/IP IP54 Installation

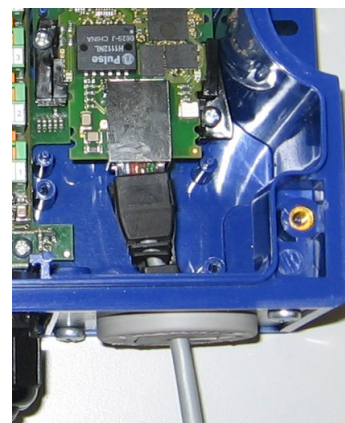
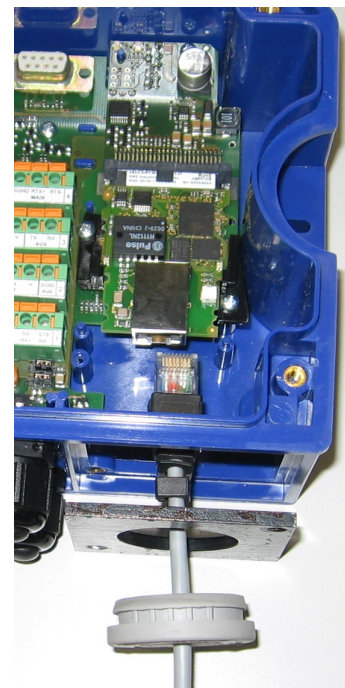
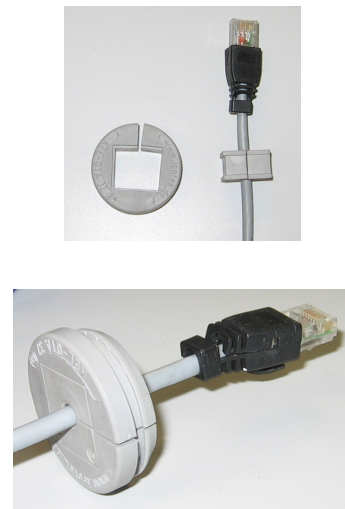

**Figure 7 –
Ethernet/IP Module
IP54 Mounting**

LED INDICATORS

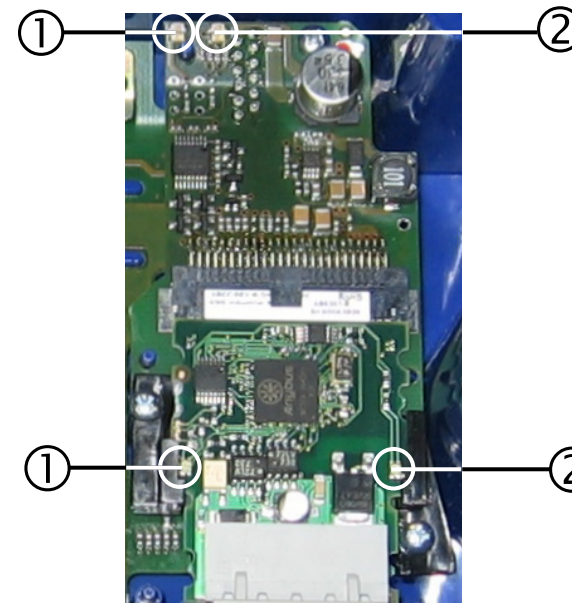

Profibus

1 = Operation Mode LED	
Off	Not on-line, No power
Green	On-line, data exchange
Flashing Green	On-line, clear
Flashing Red (1 flash)	Parameterization error
Flashing Red (2 flashes)	Profibus configuration error
2 = Status LED	
Off	No power or not initialized
Green	Initialized
Flashing Green	Initialized, diagnostic event(s) present
Red	Exception error

DeviceNet

1 = Network Status LED	
Off	Not on-line, No power
Green	On-line, one or more connections established
Flashing Green (1 Hz)	On-line, no connections established
Red	Critical link failure
Flashing Red (1 Hz)	One or more connections timed-out
Alternating Red/Green	Self test
2 = Module Status LED	
Off	No power
Green	Operating in normal condition
Flashing Green (1 Hz)	Missing or incomplete configuration, device needs commissioning
Red	Unrecoverable fault(s)
Flashing Red (1 Hz)	Recoverable fault(s)
Alternating Red/Green	Self test

Ethernet/IP

1 = Network Status LED	
Off	No power or no IP address
Green	On-line, one or more connections established (CIP Class 1 or 3)
Flashing Green	On-line, no connections established
Red	Duplicate IP address, Fatal error
Flashing Red	One or more connections timed-out (CIP Class 1 or 3)
2 = Module Status LED	
Off	No power
Green	Controlled by a Fieldbus Master in Run state
Flashing Green	Not configured or Fieldbus Master in Idle state
Red	Major fault (Exception state, Fatal error, etc.)
Flashing Red	Recoverable fault(s)

CANopen

1 = Run LED	
Off	No power
Green	In Operational state
Blinking Green	In Pre-operational state
Flashing Green (1 flash)	In Stopped state
Flickering Green	Autobaud
Red	In Exception state, Fatal event
2 = Error LED	
Off	No power
Flashing Red (1 flash)	Bus error counter warning limit reached
Flickering Red	LSS services are in progress
Flashing Red (2 flashes)	Error control event
Red	Bus off, Fatal event

Profinet

1 = Network Status LED	
Off	No power, No connection with IO controller
Green	Connection with IO controller established, IO controller in Run state
Green flashing	Connection with IO controller established, IO controller in Stop state
2 = Module Status LED	
Off	No power or Not Initialized
Green	Normal operation
Flashing Green (1 flash)	Diagnostic event(s)
Flashing Green (2 flashes)	Blink (node identification)
Red	Exception error
Flashing Red (1 flash)	Configuration error
Flashing Red (2 flashes)	IP address not set
Flashing Red (3 flashes)	Station Name not set
Flashing Red (4 flashes)	Internal error

CC-Link

1 = Run LED	
Off	No power, No network participation, Timeout status
Green	Participating, normal operation
Red	Major fault, Fatal error
2 = Error LED	
Off	No power or no error detected
Red	Major fault, (Exception or Fatal event)
Flickering Red	CRC error (temporary flickering)
Flashing Red	Station Number or Baud rate has changed since startup

Modbus TCP

1 = Network Status LED	
Off	No power or no IP address
Green	Module is in Process Active or Idle state
Flashing Green	Waiting for connections
Red	Duplicate IP address, or Fatal event
Flashing Red	Process Active Timeout
2 = Module Status LED	
Off	No power
Green	Normal operation
Red	Major fault (Exception state, Fatal error, etc.)
Flashing Red	Minor fault

Ethernet TCP/IP

Network Link Status LED	Yellow	Network Activity Status LED	Green
Network Link Status LED			
Off			No link has been detected
Yellow			Network link has been detected
Network Activity Status LED			
Off			No network activity
Flashing Green			Network data is transmitted or received

Connect the shield wire to the Earth terminal connector.