

SG-BWS-T4-MT



Instruction Manual



ORIGINAL INSTRUCTIONS (ref. 2006/42/EC)

Datalogic Automation S.r.l.
Via Lavino, 265
40050 - Monte S. Pietro
Bologna - Italy

SG BWS-T4-MT Instruction Manual

Ed.: 08/2012

© 2012 Datalogic Automation S.r.l. □ ALL RIGHTS RESERVED. □ Protected to the fullest extent under U.S. and international laws. Copying, or altering of this document is prohibited without express written consent from Datalogic Automation S.r.l.

Datalogic and the Datalogic logo are registered trademarks of Datalogic S.p.A. in many countries, including the U.S.A. and the E.U.

All brand and product names mentioned herein are for identification purposes only and may be trademarks or registered trademarks of their respective owners.

Datalogic shall not be liable for technical or editorial errors or omissions contained herein, nor for incidental or consequential damages resulting from the use of this material.

08/08/12



Datalogic Automation S.r.l.

Via Lavino 265

40050 Monte San Pietro

Bologna - Italy

www.automation.datalogic.com

declares that the

**SG-BWS-T4 ; CONTROL UNIT - ELECTRO-SENSITIVE PROTECTIVE EQUIPMENT
(TYPE 4 ESPE)**

and all its models

are in conformity with the requirements of the European Council Directives listed below:

2006 / 42 / EC Machinery Directive

2004 / 108 / EC EMC Directive

2006 / 95 / EC Low Voltage Directive

This Declaration is based upon compliance of the products to the following standards:

EN 61496-1: 2004	SAFETY OF MACHINERY - ELECTRO-SENSITIVE PROTECTIVE EQUIPMENT. PART 1: GENERAL REQUIREMENTS AND TESTS
IEC 61496-2: 2006	SAFETY OF MACHINERY - ELECTRO-SENSITIVE PROTECTIVE EQUIPMENT. PART 2: PARTICULAR REQUIREMENTS FOR EQUIPMENT USING ACTIVE OPTO-ELECTRONIC PROTECTIVE DEVICES (AOPDs)
IEC 61508-1/3/4: 1998	FUNCTIONAL SAFETY OF ELECTRICAL/ELECTRONIC/PROGRAMMABLE ELECTRONIC SAFETY-RELATED SYSTEMS.
IEC 61508-2:2000	
EN 954-1: 1996	SAFETY OF MACHINERY - SAFETY-RELATED PARTS OF CONTROL SYSTEMS
EN ISO 13849-1: 2008	SAFETY OF MACHINERY - SAFETY-RELATED PARTS OF CONTROL SYSTEMS - PART 1: GENERAL PRINCIPLES FOR DESIGN
EN 62061: 2005	SAFETY OF MACHINERY - FUNCTIONAL SAFETY OF SAFETY-RELATED ELECTRICAL, ELECTRONIC AND PROGRAMMABLE ELECTRONIC CONTROL SYSTEMS
EN 50178:1997	ELECTRONIC EQUIPMENT FOR USE IN POWER INSTALLATIONS
EN 61000-6-2: 2005	ELECTROMAGNETIC COMPATIBILITY (EMC) PART 6-2: GENERIC STANDARDS - IMMUNITY FOR INDUSTRIAL ENVIRONMENTS
EN 55022 (Class A ITE): 2010	LIMITS AND METHODS OF MEASUREMENTS OF RADIO DISTURBANCE OF INFORMATION TECHNOLOGY EQUIPMENT

Conformity has been certified by the following Notified/Competent Body (identification n° 0123): TÜV SÜD Rail GmbH, Rüdigerstrasse, 65 - D80339 München

Datalogic Automation have a quality system certified by the CSQ, Nr. 9115.IES2, as per ISO 9001 and have therefore observed the regulations foreseen during development and production

Monte San Pietro, January 20th 2012

Paolo Morselli
Quality Manager

Morselli Paolo



INDEX

1. GENERAL INFORMATION	1
1.1. Purpose of this document:	1
1.2. Intended readers:	1
1.3. Usage information:	1
2. PRODUCT GENERAL DESCRIPTION	2
2.1. Package Content	2
2.2. Appearance and user interface	2
2.3. Safety sensors	3
2.4. Main functions managed by the control unit:	5
2.5. Typical Applications	5
3. INSTALLATION	7
3.1. Safety information	7
3.2. Precautions to be observed for the choice and installation of the device	7
3.3. General information on sensors positioning	8
3.4. Minimum installation distance	9
3.5. Minimum distance from reflecting surfaces	11
3.6. Sensors Interference	12
3.7. Installing the safety control unit	13
3.8. Installing the sensors	13
4. ELECTRICAL CONNECTION	15
4.1. Important installation tips	15
4.2. SG-BWS-T4-MT as MPCE (Machine Primary Control Equipment)	15
4.3. SG-BWS-T4-MT as external safety relays controller	15
4.4. Minimum connections (1 photocell, no EDM, automatic restart)	16
4.5. Complete list of connections	17
4.6. Dip-Switches Setup	19
4.7. Safety light curtains connections	20
4.8. Safety photocells connection	21
4.9. Connecting the external relays and EDM	22
4.10. Reset mode and connection of the Start push-button	23
4.11. Connection of the Test/Reset push-button	24
4.12. Muting function and relevant connections	25
4.12.1. Muting function dynamic disabling:	26
4.12.2. Muting warning devices:	27
4.12.3. Lamp failure warning:	27
4.12.4. Muting applications and sensors connections:	28
4.12.5. Uni-directional (type L) muting – 2 sensors	29
4.12.6. Bi-directional (type T) muting – 2 or 4 sensors	31
4.12.7. Muting Time-out	32
4.13. Connecting the Override pushbuttons	32
5. COMMISSIONING	35
5.1. Screen indications upon switch-on	35
5.2. Alignment mode	35
6. DIAGNOSTICS AND WARNINGS	36
6.1. Normal operation signalling	36
6.2. Failure state signalling	37
7. PERIODICAL CHECKS AND WARRANTY	39
7.1. Periodical checks	39
7.2. Warranty	39
8. DEVICE MAINTENANCE	40
8.1. Product disposal	40
9. TECHNICAL DATA	41
10. ORDER DATA	42
11. OVERALL DIMENSIONS	44
11.1. SG-BWS-T4-MT	44
11.2. S5-ST2, S5-ST4, SL5-ST4, S300	44
12. APPENDIX	45
12.1. FIGURE INDEX:	45
12.2. TABLES INDEX:	45

1. GENERAL INFORMATION

Read this section carefully before implementing the instructions given in this manual and starting up the SG-BWS-T4-MT safety system.

1.1. Purpose of this document:

These instructions for use are addressed to the manufacturer technicians or staff operating the machine and give all necessary instructions for correct and safe assembly, setup, electric connection and commissioning of the SG-BWS-T4-MT safety system.

Scope of this document excludes information about use of the machine the safety system is installed to.

1.2. Intended readers:

The instructions for use given herein are addressed to designers, manufacturers and persons in charge of the safety of systems to be equipped with the SG-BWS-T4-MT. They are also addressed to the staff in charge of installing the SG-BWS-T4-MT to a machine, commissioning it or servicing it.

1.3. Usage information:

These instructions for use contain the following details about the SG-BWS-T4-MT:

- installation	- diagnostics and troubleshooting
- electrical connection	- user interface warnings
- commissioning and setup	- conformity and type approval
- application	- care and maintenance





Tab. 1 User manual main contents

Designing and using safety devices to integrate to the SG-BWS-T4-MT requires specific know-how which is not included in this document. In particular, the applicable industry standards shall be met. General information about accident-prevention protection by means of optoelectronic safety devices can be found in the “Safety guide” available on the product CD-Rom provided with SG-BWS-T4-MT.

Acronyms used:

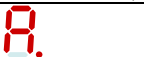
ESPE	Electro sensitive protective equipment: used instead of SG-BWS-T4-MT
EDM	External device monitoring
SAFCN	SAFety CoNtact: control unit output, i.e. safety internal relay NO contact monitored by the control unit.
OSSD	Output signal switching device: output signal that can control an external safety circuit.
LED	Light emitting diode

Definitions, symbols used:

	Constant viewing of characters, e.g. A
	Alternated viewing of characters, e.g. U and 5
 SAFE	The red LED is always ON
 NORMAL	The LED is OFF
 NORMAL	The green LED flashes



Warning: indicates safety-related critical information. Carefully read and follow given instructions.

2. PRODUCT GENERAL DESCRIPTION

2.1. Package Content

- Safety Control Unit SG-BWS-T4-MT
- Quick operations guide
- Cd-Rom with this user manual and other contents
- Six-monthly checklist for periodic check and maintenance

2.2. Appearance and user interface

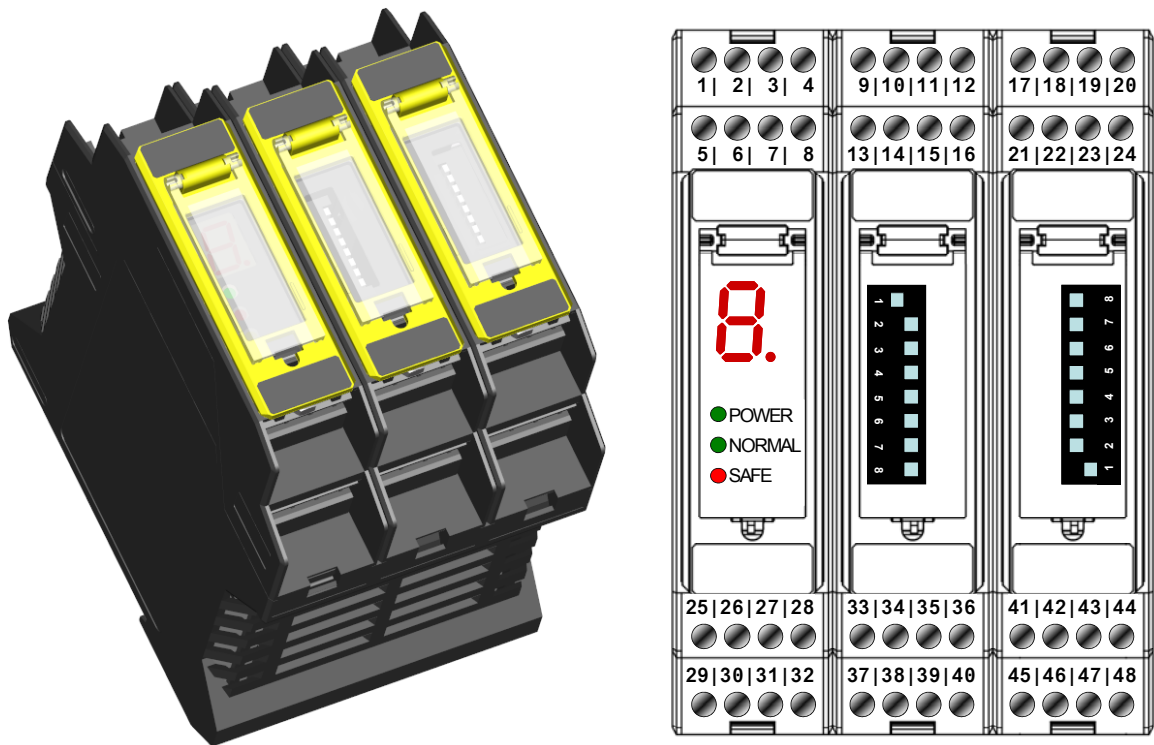

Fig. 1 SG-BWS-T4-MT Appearance and user interface

SG-BWS-T4-MT safety system consists of a control unit enclosed in a plastic housing, to be installed on OMEGA/DIN rail, equipped with 48 screw clamps that can be connected up to 4 sets of photocells of the S5-ST, SL5-ST, S300 series and to up to 2 safety light curtains.

System was designed making reference to the following regulations and standards:

EN 61496-1: 2004	Safety of machinery: electrosensitive protective equipment. Part 1: General requirements and tests.
CLC/TS 61496-2: 2006	Safety of machinery: electro-sensitive protective equipment. Particular requirements for equipment using active optoelectronic protective devices.

The control unit fits some safety outputs controlled through two 230V relays, according to the status of each and every sensor connected to the system: when a photocell or light curtain detects any dangerous condition, this opens the outputs.

At the top of SG-BWS-T4-MT is user interface for viewing warnings and setup.

Further to the 7-segment display (for diagnostics purposes) the warning components include 3 LEDs:

LED	Indication
● POWER	Device is powered correctly
● NORMAL	Safety outputs closed
● SAFE	Safety outputs open

Tab. 2 Signalling LEDs

The device setup Dip-Switches are located on the sides, please refer to section 4. The user interface and the Dip-Switches are protected against unauthorised access by means of clear flaps that can only be opened via a small flat-blade screwdriver, less than 3mm wide.

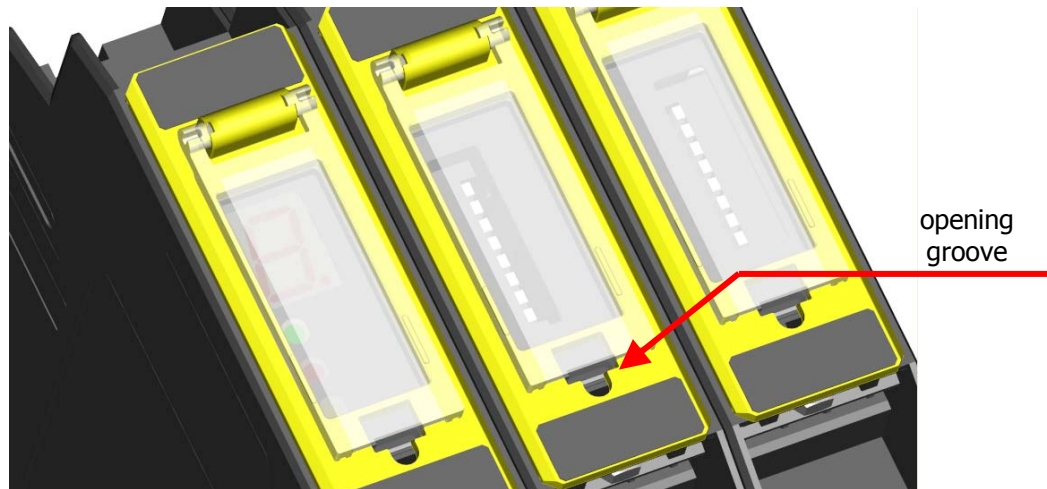

Fig. 2 Protective Flaps

2.3. Safety sensors

4 types of photocells can be connected to the safety control unit:

- S5-5-X-X-SG-ST2: Type 2 safety photocell emitting infrared beams.
- S5-5-X-X-SG-ST4: Type 4 safety photocell emitting infrared beams.
- SL5-5-X-X-SG-ST4: Type 4 safety photocell emitting long-distance red laser beam.
- S300-PR-5-X-X-ST4: Type 4 safety photocell for long-distance applications.
- S300-PR-5-X-X-ST2: Type 4 safety photocell for long-distance applications.

See section 10 "Order data" for further details about available photocell models.



Using the above photocells independently from SG-BWS-T4-MT does not meet EN 61496-1 and CLC/TS 61496-2 requirements and is thus not allowed.
Connection of Type 2 photocells results in the whole system category downgrade to Type 2.

S5 and SL5 sensors are housed in plastic tube casings featuring M18x1 thread.

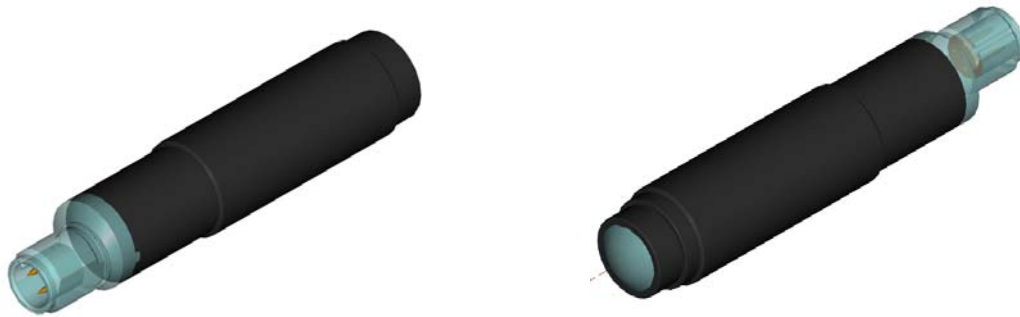

Fig. 3 Safety single beam photocells S5,SL5 series (appearance)

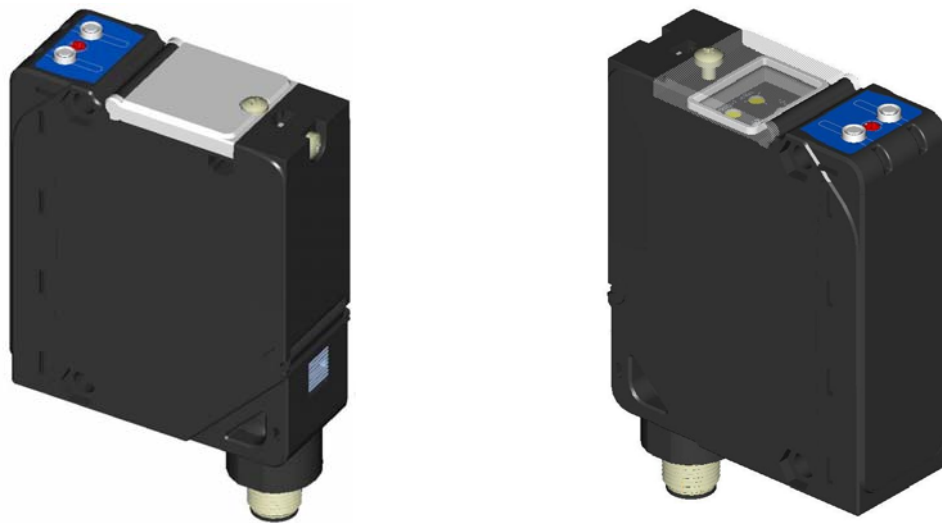

Fig. 4 S300 series safety photocells

The photocells are equipped with LEDs for operation status indication:

SENSOR	LED	INDICATION
S5/SL5/S300 Emitter	● Green	Sensor correctly powered
S5 Receiver	● Green	Sensor correctly powered
	○/★ Green	Poor/insufficient signal received
	● Red	Output active
	○ Red	Output not active
SL5/S300 Receiver	● Green	Sensor correctly powered
	○/★ Green	Poor/insufficient signal received
	● Yellow	Output active
	○ Yellow	Output not active

Tab. 3 Photocells signalling

Please refer to the relevant user manual for further details about photocells operation. The SG-BWS-T4-MT system also allows for connection of up to two safety light curtains of the SG and SE Series and can even power them.

2.4. Main functions managed by the control unit:

- **Manual/Automatic restarting:** select whether the safety outputs are automatically closed when danger condition no longer applies or if this should happen after a manual enabling command output through a restarting selector.
- **EDM:** the control unit can monitor any external contactors possibly connected downstream.
- **Muting:** it is possible to disable the safety function of one or more sensors connected to the control unit in order to allow passage of material yet avoiding machine stoppage, for instance. In particular, the control unit features two separate channels for the muting function that can be individually associated to pairs of photocells or light curtains. Every channel is controlled by 2 or 4 sets of suitable sensors, depending on whether muting function is uni- or bi-directional, respectively.
- **Override:** it forces system to close the output relays even when beam is interrupted, in order to allow passage of material possibly blocked in front of the safety sensors.



Muting and Override are two ways of forcing the system because they compromise system safety level. Closely comply with use instructions under paragraphs 4.10-4.11.

2.5. Typical Applications

The SG-BWS-T4-MT system is typically used as a protection to the access to dangerous areas on machines or systems. The sensors are fixed and installed to the access area at the suitable safety distance from the nearest danger source and output a stop control to the machine or system, if the light beam is interrupted.

Moreover, since it can connect up to 2 safety light curtains, SG-BWS-T4-MT can also be used for protecting operating areas requiring evolved functions not implemented on light curtains SG and SE series.

Hereafter are shown some application examples with SG-BWS-T4-MT.

Example 1: Conveyors and robot protection

The protection of the conveyor is obtained using both safety photocells and light curtains.

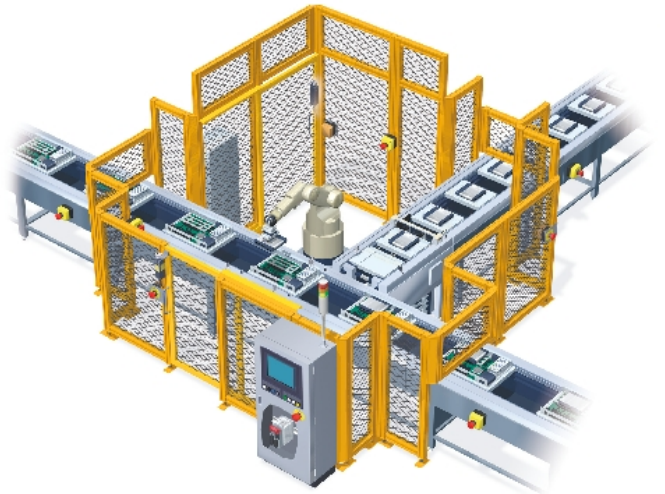

Fig. 5 Conveyor protections

Solution: SG-BWS-T4-MT is able to censure a complete Cat. 4 protection as requested by the machine typology thanks to the integrated muting function and the possibility of driving both the safety photocells and light curtains.

Advantages: SG-BWS-T4-MT: one single device that driver both the light curtains and photocells with two separate muting channels instead of having different single function modules. Consequently, costs are reduced and the mounting is facilitated.

Example 2: Automatic warehouses

The access of both moving bay sides has to be protected in order to prevent operators entering the dangerous area.

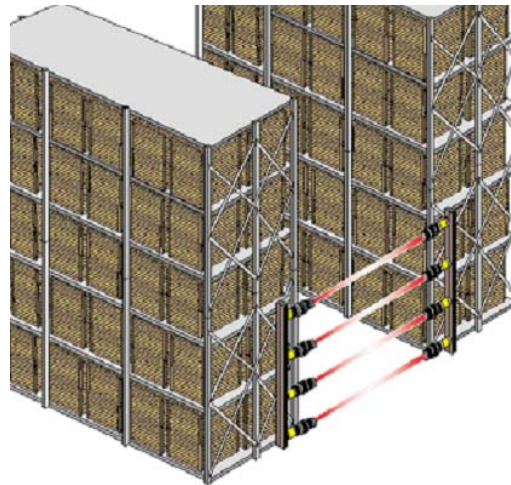

Fig. 6 Automatic warehouses protection with photocells

Solution: safety photocells are installed on both sides of the bay that are connected and driven by one SG-BWS-T4-MT control unit.

Advantages: the use of tubular photocells enables installation even in reduced spaces in the warehouse structure. SG-BWS-T4-MT is ideal for all applications where protection has to be guaranteed without additional safety functions.

Example 2: SMD machine protection

The access to a dangerous area must be enabled in order to carry-out maintenance procedures. The access must be allowed by stopping only the specific area by opening the doors and not the entire machine.

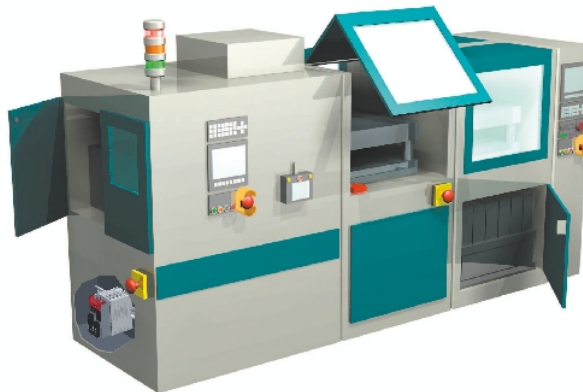

Fig. 7 Doors control by means of safety photocells

Solution: SG-BWS-T4-MT is able to detect the door opening by using one or more photocells by intersecting the interrupted beams, guaranteeing the safety condition.

Advantages: all the safety interlocks can be replaced on each door thanks to the use of photocells and so reducing the plant cost as well as increasing flexibility.

3. INSTALLATION

3.1. Safety information



For a correct and safe use of the SG-BWS-T4-MT, the points considered in this section must be observed.

The stopping system of the machine must be electrically controlled. This control system must be able to stop the dangerous movement of the machine within the total machine stopping time T as per par. 3.4, and during all working cycle phases.

The safety system should be installed and connected by a qualified technician in compliance with the instructions specified in this manual and industry rules.

The photocells or light curtains must be securely installed in a particular position so that access to the dangerous zone is not possible without the interruption of the beams (see 3.3 "General information on sensors positioning").

The personnel operating in the dangerous area must be well trained and must have adequate knowledge of all the operating procedures of the safety control unit.

The START and TEST buttons must be located outside the protected area because the operator must check the protected area during all Test and Reset operations.

Please carefully read the instructions for the correct functioning before powering the SG-BWS-T4-MT.

3.2. Precautions to be observed for the choice and installation of the device



Make sure that the protection level assured by the device is compatible with the real danger level of the machine to be controlled, according to EN 954-1 and EN 13849-1.

- The outputs (SAFCN) of the ESPE must be used as machine stopping devices and not as command devices. The machine must have its own START command.
- The dimension of the smallest object to be detected must be larger than the resolution level of the installed safety sensors.
- The ESPE must be installed in a room complying with the technical characteristics indicated in section 9 "Technical data".
- Do not install the sensors close to strong and/or flashing light sources or close to similar devices.
- Strong electromagnetic disturbance might negatively affect device operation. Should this be the case contact Datalogic Automation Technical Service.
- The operating distance of the safety sensors can be reduced in presence of smog, fog or airborne dust.
- A sudden change in environment temperature, with very low minimum peaks, can generate a small condensation layer on the sensors lenses and so jeopardise functioning.

3.3. General information on sensors positioning

Pay special care when positioning the safety photocells and light curtains so to offer effective protection. The safety sensors should be installed in such a way that the dangerous area can only be accessed after intercepting the sensitive area.

Photocells position is fixed by normative and must respect measures in Tab. 4.



Below are some examples of possible access to the machine from the top and the bottom sides. These situations may be very dangerous and so the installation of the safety light curtain at sufficient height in order to completely cover the access to the dangerous area becomes necessary.

NO

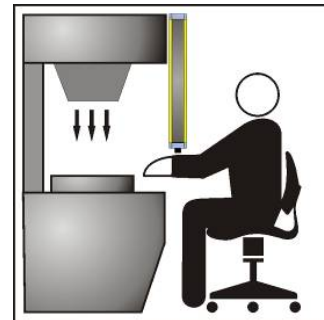
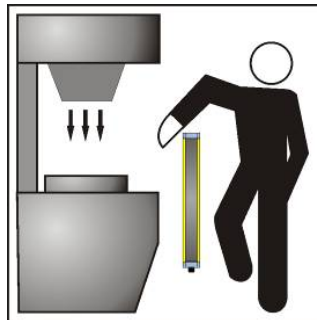

YES



Fig. 8 Safety light curtain positioning



Under standard operating conditions, machine starting must not be possible while operators are inside the dangerous area.

If the operator is able to enter the dangerous area although ESPE positioning, an additional mechanical protection must be mounted to prevent the access.

3.4. Minimum installation distance

The safety device must be positioned at a specific safety distance. This distance must ensure that the dangerous area cannot be reached before the dangerous motion of the machine has been stopped by the ESPE.

The safety distance depends on 4 factors, according to the EN-999 Standard:

- Response time of the ESPE (the time between the effective sensors beam interruption and the opening of the SAFCN contacts).
- Machine stopping time (the time between the effective opening of the contacts of the ESPE and the real stop of the dangerous motion of the machine).
- ESPE resolution.
- Approaching speed of the object to be detected.

SG-BWS-T4-MT response time is 35ms.

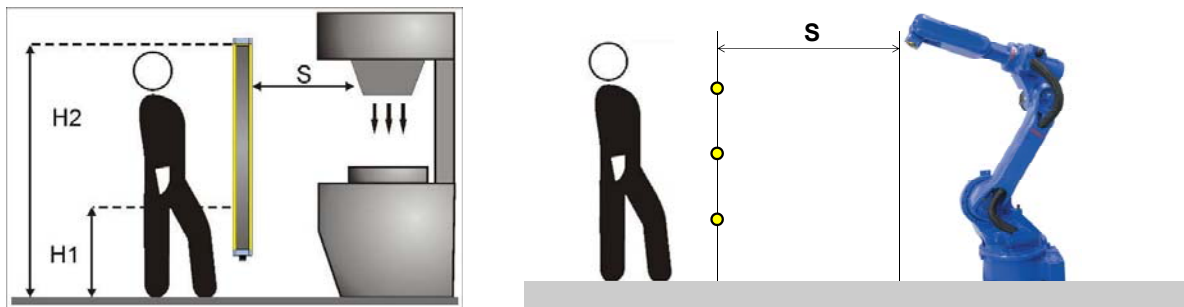

Fig. 9 Safety Distance

The following formula is used for the calculation of the safety distance:

$$S = K (t_1 + t_2 + t_3) + C$$

where:

- S** = Minimum safety distance in mm
- K⁽¹⁾** = Speed of the object, limb or body approaching the dangerous area in mm/s
- t₁** = SG-BWS-T4-MT response time in seconds (0.035)
- t₂** = The higher response time of all times for the safety sensors connected to SG-BWS-T4-MT
- t₃** = Machine stopping time in seconds
- d** = Resolution of the system.
- C⁽²⁾** = Additional distance based on the possibility to insert the body or one of body parts inside the dangerous area before the protective device trips.

(1) K is:

- 2000 mm/s if the calculated value of S is ≤ 500 mm
- 1600 mm/s if the calculated value of S is > 500 mm

(2) C is:

- 8 (d - 14) for devices with resolution ≤ 40 mm (safety light curtains)
- 850mm for devices with resolution ≥ 40mm (multibeam protections and light curtains)
- 1200mm for single optics systems

With multibeam light curtains, beam height from the ground must comply with the following chart:

		4 beams	3 beams	2 beams	1 beam
Beam height (mm)	1st	300	300	400	750
	2nd	600	700	900	
	3rd	900	1100		
	4th	1200			

Tab. 4 Beams height for photocells protections

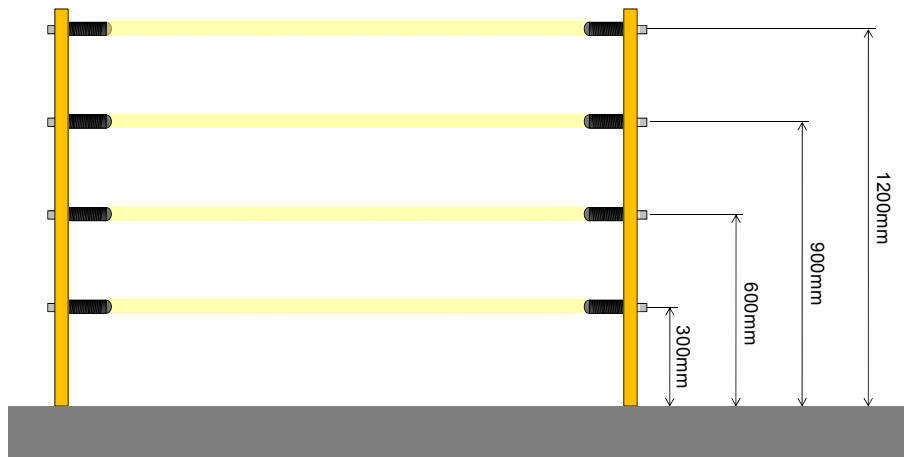

Fig. 10 Photocells installation heights for 4 beams protections

Please refer to the corresponding user manual for installation of any other type of safety light curtain.

• **Example 1: SG4-14-060 safety light curtain (14mm resolution, 600mm protected height, 22ms response time)**

To calculate the distance of the device from the ESPE, in a vertical position, the following formula is used:

$$S = K (t_1 + t_2 + t_3) + C$$

where:

t ₁	=	SG-BWS-T4-MT response time	35 ms
t ₂	=	light curtain response time	22 ms
t ₃	=	machine stopping time	290 ms
P	=	8 · (d - 14) for devices with resolution d ≤ 40 mm	0 mm

if K = 2000mm/sec then S > 500 mm. Distance will have then to be recalculated using K = 1600 mm/sec.

$$S = 1600 \cdot 0.347 + 0 = 555 \text{ mm}$$



The reference standard is EN999 “Machine safety - the positioning of the protective device based on the approaching speed of the human body”. The following information is to be considered as indicative and concise. For correct safety distance please refer to complete standard EN-999.

• **Example 2: light curtain with 4 S5 photocells**

Using the same formula as above, we obtain:

$$S = K (t_1 + t_2 + t_3) + C$$

T	=	t ₁ + t ₂	
t ₁	=	SG-BWS-T4-MT response time	35 ms
t ₂	=	S5 response time	1.5 ms
t ₃	=	machine total stopping time	290 ms
P	=	850 mm for devices with resolution ≥ 40 mm.	850 mm

$$S = 1600 \cdot 0.327 + 850 = 1372 \text{ mm}$$

3.5. Minimum distance from reflecting surfaces

Reflecting surfaces placed near the light beams of the safety device (over, under or laterally) can cause passive reflections. These reflections can compromise the recognition of an object inside the controlled area.

However, if the RX receiver detects a secondary beam (emitted again by the side-reflecting surface) the object might not be detected, even if the object interrupts the main beam.

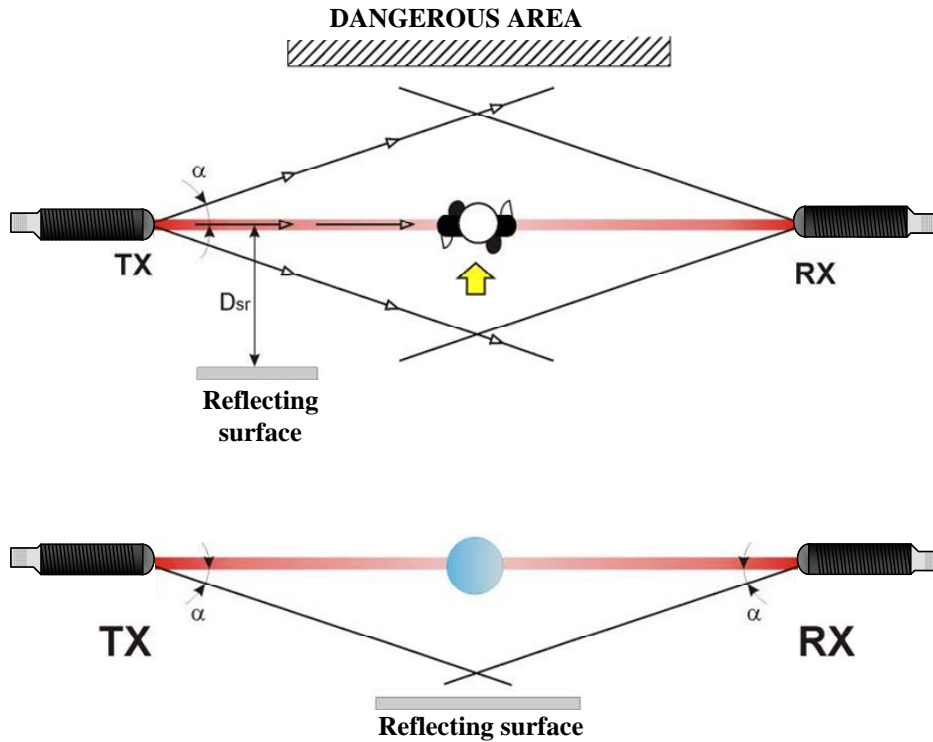

Fig. 11 Distance from reflecting surfaces

It is thus important to position the photocells or light curtains according to the minimum distance D_{sr} from reflecting surfaces.

The minimum distance depends on:

- operating distance between emitter (TX) and receiver (RX);
- real opening angle of ESPE (EAA), especially:
 - for ESPE type 4 EAA = 5° ($\alpha = \pm 2,5^\circ$)
 - for ESPE type 2 EAA = 10° ($\alpha = \pm 5^\circ$)

The formula to get D_{sr} is the following:

$$\left\{ \begin{array}{l} D_{sr} \text{ (m)} = 0.15 \\ D_{sr} \text{ (m)} = 0.5 \times \text{operating distance (m)} \times \text{tg (EAA)} \end{array} \right. \begin{array}{l} \text{for operat. dist. } < 3 \text{ m} \\ \text{for operat. dist. } \geq 3 \text{ m} \end{array}$$

3.6. Sensors Interference

When several safety devices must be installed in adjacent areas, interference between the emitter of one device and the receiver of the other must be avoided.

The safety light curtains are equipped with suitable commands to avoid any dangerous situation due to interference. In the same way, SG-BWS-T4-MT monitors possible interference between photocells and locks out if any interference is detected.

Please refer to the safety light curtain manual for further details on this matter.

Suitable installation precautions could avoid any interference issue between similar devices.

This typically applies to cases when many devices are installed side-by-side and in line, such as for systems featuring several goods loading/unloading areas, parallel one to the other and whose entrance is protected by safety light curtains.

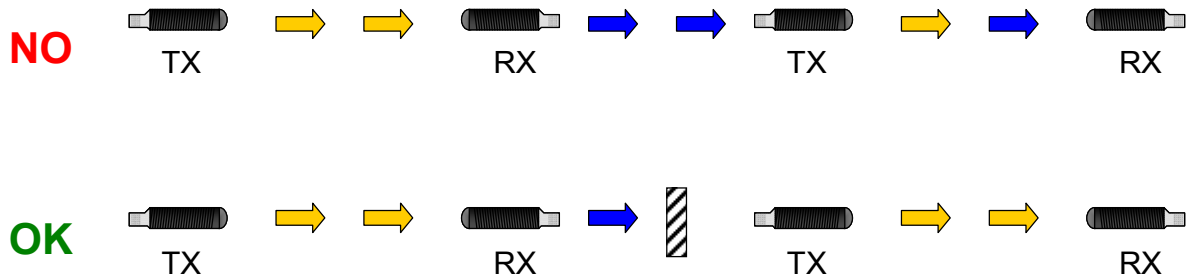

Fig. 12 Sensors disposal in order to avoid interferences

To make sure that photocell parallel beams do not create interference, it is necessary to install the photocells considering a minimum centre distance D_{do} that depends on operating distance D_{op} .

To make this concept clearer, the chart below shows it for the S5-ST2, S5-ST4, SL5-ST4 series photocells.

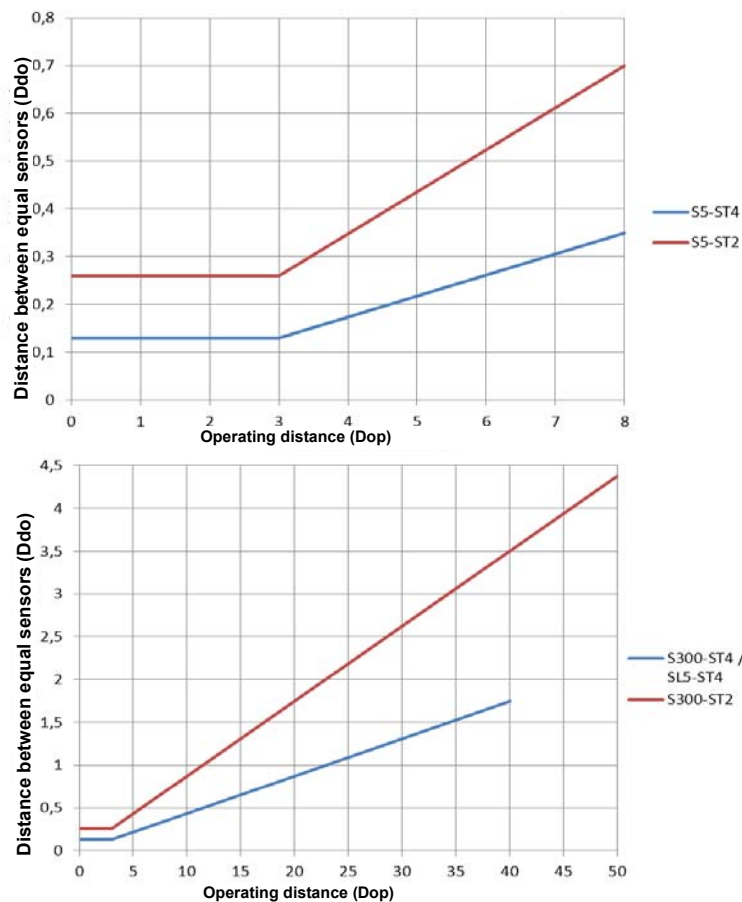

Fig. 13 Distance between equal sensors

3.7. Installing the safety control unit

The SG-BWS-T4-MT control unit is simply installed onto an OMEGA/DIN rail placed inside a control panel.

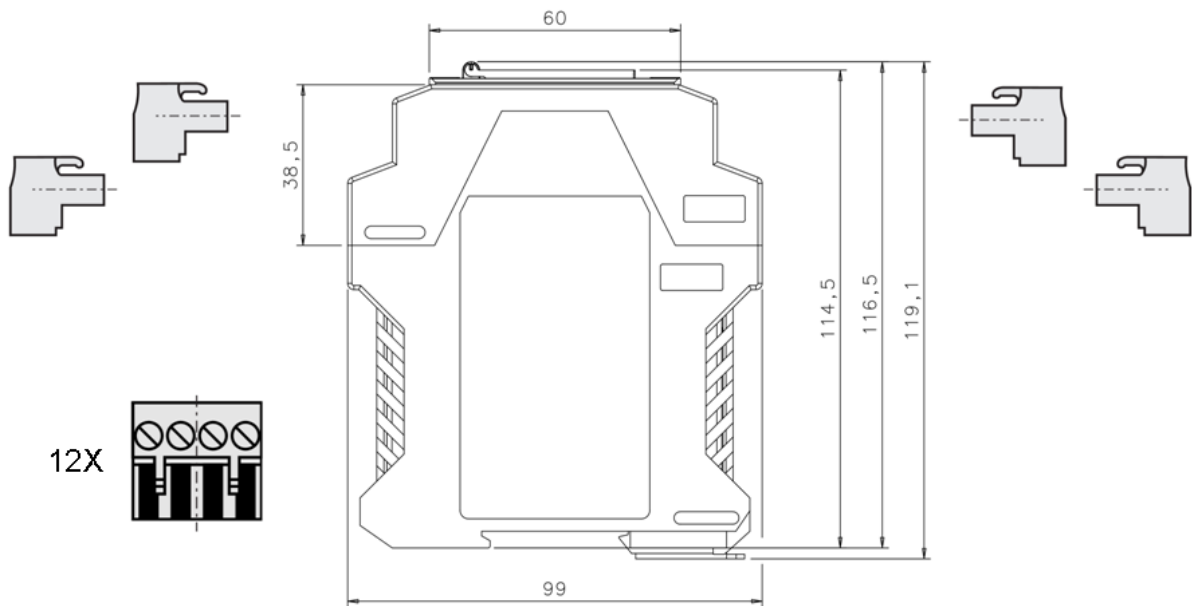

Fig. 14 Safety Control Unit mounting

The 12 4-pole connection terminals can be disconnected quite easily using a flat-blade screwdriver and can be connected by hand.

3.8. Installing the sensors

S5 and SL5 sensors can be installed exploiting the body M18x1 thread, on through hole (□ 18 mm), using the washer and the two nuts supplied.

Please refer to the relevant user manual supplied for further details about the installation of s300 series sensors.

Various adjustable brackets are available to help sensor positioning (see 10.3 “Accessories”). Please refer to the photocell user manual for further details about installation.



Upon installation, make sure to correctly align the emitter and receiver. Emitter and receiver optics shall be on the same axis.

Take any due precaution to reduce vibrations when application requirements are stricter than specifications indicated under section 9 “Technical data”.

During assembly, strictly comply with the instructions given under 3.4 “Minimum installation distance” and 3.5 “Minimum distance from reflecting surfaces”

- **Use of deviating mirrors**

The control of any dangerous area, with several but adjacent access sides, is possible using only one safety device and well-positioned deviating mirrors.

The figure shows a possible solution to control three different access sides, using two mirrors placed at 45° with respect to the beams.

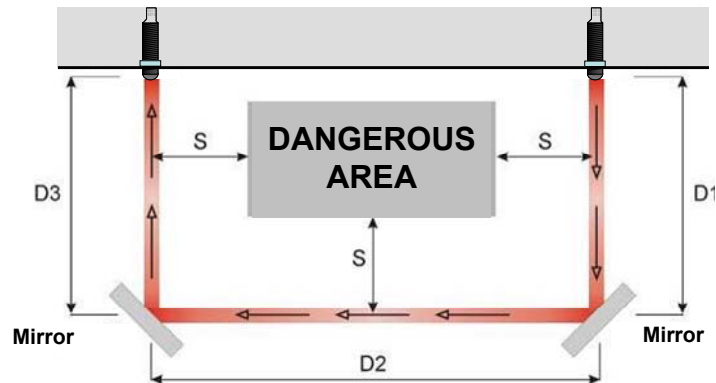

Fig. 15 Deviating Mirros

The operator must respect the following precautions when using the deviating mirrors:

- It is very hard to align the receiver and the transmitter when using deviating mirrors: a tiny angular shift of the mirror is enough to have a misalignment.
- The minimum safety distance (S) must be respected for each single section of the beams.
- The effective operating range decreases by about 15% by using only one deviating mirror, the percentage further decreases by using 2 or more mirrors (for more details refer to the technical specifications of the mirrors used).
- The presence of dust or dirt on the reflecting surface of the mirror causes a drastic reduction in the range.

4. ELECTRICAL CONNECTION

4.1. Important installation tips



Do not place connection cables in contact with or near high-voltage cables and/or cable undergoing high current variations (e.g. motor power supplies, inverters, etc.);

Do not connect in the same multi-pole cable the wires for control unit safety outputs or the OSSD wires of different light curtains.

Do not connect in the same multi-pole cable both emitter and receiver of a set of photocells.

All devices are protected internally against overvoltage and overcurrent: the use of other outer parts is not recommended.

4.2. SG-BWS-T4-MT as MPCE (Machine Primary Control Equipment)

SG-BWST-T4-MT can be directly used as a Machine Primary Control Equipment (MPCE) since it's equipped with internal monitored relays which can switch a maximum load of 3,6A at 250V.

The proper connections are shown in Fig. 16.

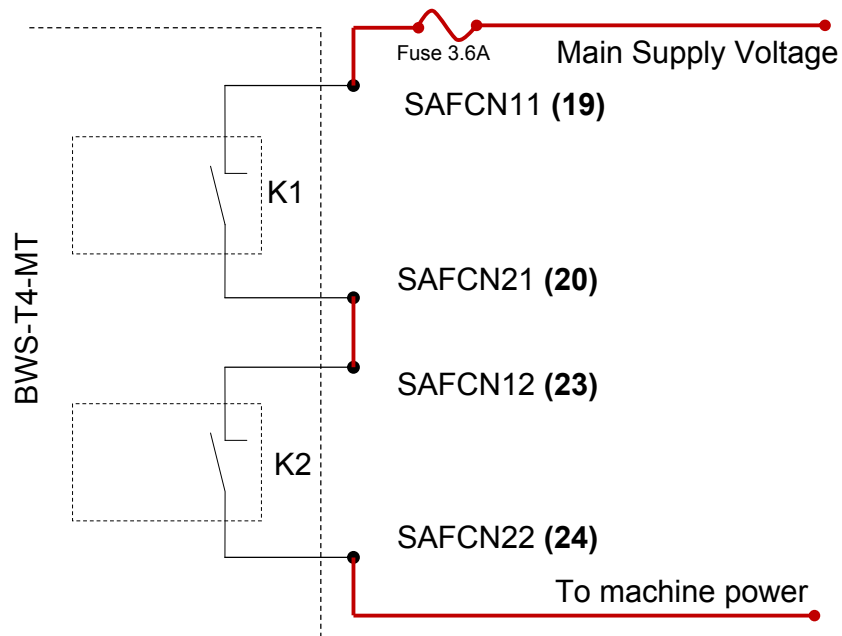

Fig. 16 SG-BWS-T4-MT connection to machine power supply

4.3. SG-BWS-T4-MT as external safety relays controller

When utilizing SG-BWS-T4-MT for external safety relays control proper connections are shown in 4.9 "Connecting the external relays and EDM"

4.4. Minimum connections (1 photocell, no EDM, automatic restart)

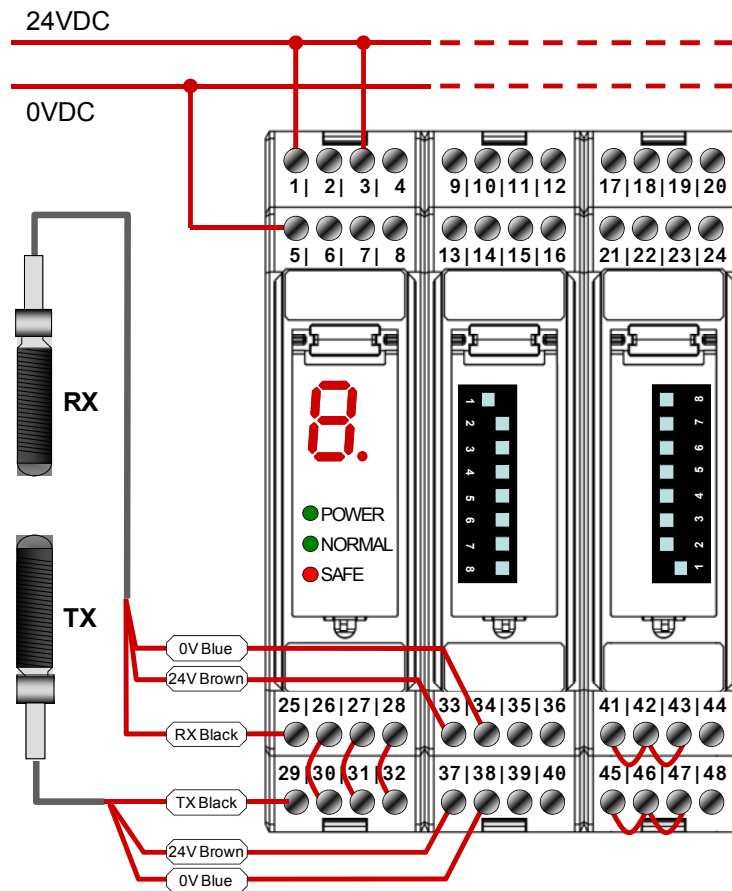

Fig. 17 Minimum connection for function test

The control unit terminals layout and the minimum connection to check system operation are shown below. The photocells set power (blue and brown wires) reaches terminals 33-34, 37-38 as specified in the table.

SIGNAL	TERMINAL	CONNECTION	FUNCTION
VDC	1	24 Vdc ext.	Power
TEST/RESET	3	24 Vdc ext.	Test function
0 V	2	0 Vdc ext.	Power
RX1	25	PNP output of receiver photocell 1 (black)	Photocell Input
TX1	29	TEST of emitter photocell 1 (black)	Photocell Output
RX2	26	TX2 (30)	Photocell Input
RX3	27	TX3 (31)	Photocell Input
RX4	28	TX4 (32)	Photocell Input
OSSD11	41	OSSD21 (42)	Safety light curtain input
OSSD21	42	24LRX12 (43)	Safety light curtain input
OSSD12	45	OSSD22 (46)	Safety light curtain input
OSSD22	46	24LTX12 (47)	Safety light curtain input
24VRX12	33	24VDC power supply RX (brown)	Power supply output
0VRX12	34	0VDC power supply RX (blue)	Power supply output
24VTX12	37	24VDC power supply TX (brown)	Power supply output
0VTX12	38	0VDC power supply TX (blue)	Power supply output

Tab. 5 Minimum connection details for function test

4.5. Complete list of connections

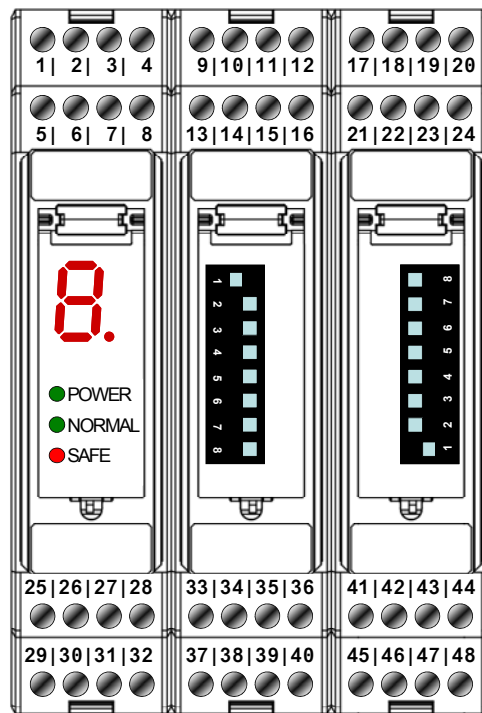

Fig. 18 Connection clamps disposal

SIGNAL	TERMINAL	CONNECTION	FUNCTION
VDC	1	24 Vdc ext.	Power
START	2	NO contact toward 24VDC	Reset Function
TEST/RESET	3	NC contact toward 24VDC	Test/Reset function
EDM	4	- NC contact of external relay toward 24 VDC (with EDM enabled) - NOT CONNECTED (with EDM disabled)	EDM Input
0 V	2	0 Vdc ext.	Power
MUTEN A	6	NO contact toward 24VDC	Muting enable
MUTEN B	7	NO contact toward 24VDC	Muting enable
DEFLAMP	8	Warning device positive terminal	Lamp failure warning
MUTA1	9	PNP output of muting sensor A1	Muting input
OVRA1	10	Override A1 NO contact toward 24VDC	Override input
MUTB1	11	PNP output of muting sensor B1	Muting input
OVRB1	12	Override B1 NO contact toward 24VDC	Override input
MUTA2	13	PNP output of muting sensor A2	Muting input
OVRA2	14	Override A2 NO contact toward 24VDC	Override input
MUTB2	15	PNP output of muting sensor B2	Muting input
OVRB2	16	Override B2 NO contact toward 24VDC	Override input
LAMPA-	17	Negative terminal of muting lamp A	Muting lamp output
LAMPA+	18	Positive terminal of muting lamp A	Muting lamp output
SAFNC11	19	Relays output NO 230V 1	Safety contact
SAFNC21	20		Safety contact
LAMPB-	21	Negative terminal of muting lamp B	Muting lamp output
LAMPB+	22	Positive terminal of muting lamp B	Muting lamp output
SAFNC12	23	Relays output NO 230V 2	Safety contact
SAFNC22	24		Safety contact
RX1	25	PNP output of receiver photocell 1 (black)	Photocell Input
RX2	26	PNP output of receiver photocell 2 (black)	Photocell Input
RX3	27	PNP output of receiver photocell 3 (black)	Photocell Input

SIGNAL	TERMINAL	CONNECTION	FUNCTION
RX4	28	PNP output of receiver photocell 4 (black)	Photocell Input
TX1	29	TEST of emitter photocell 1 (black)	Photocell Output
TX2	30	TEST of emitter photocell 2 (black)	Photocell Output
TX3	31	TEST of emitter photocell 3 (black)	Photocell Output
TX4	32	TEST of emitter photocell 4 (black)	Photocell Output
24VRX12	33	24VDC photocell receivers 1 and 2 (brown)	Power supply output
0VRX12	34	0VDC photocell receivers 1 and 2 (blue)	Power supply output
24VRX34	35	24VDC photocell receivers 3 and 4 (brown)	Power supply output
0VRX34	36	0VDC photocell receivers 3 and 4 (blue)	Power supply output
24VTX12	37	24VDC photocell emitters 1 and 2 (brown)	Power supply output
0VTX12	38	0VDC photocell emitters 1 and 2 (blue)	Power supply output
24VTX34	39	24VDC photocell emitters 3 and 4 (brown)	Power supply output
0VTX34	40	0VDC photocell emitters 3 and 4 (blue)	Power supply output
OSSD11	41	OSSD 1 output of light curtain 1 (grey)	Safety light curtain input
OSSD21	42	OSSD 1 output of light curtain 2 (grey)	Safety light curtain input
24LRX12	43	24VDC light curtain receivers 1 and 2 (brown)	Power supply output
0LRX12	44	0VDC light curtain receivers 1 and 2 (brown)	Power supply output
OSSD12	45	OSSD 2 output of light curtain 1 (pink)	Safety light curtain input
OSSD22	46	OSSD 2 output of light curtain 2 (pink)	Safety light curtain input
24LTX12	47	24VDC light curtain emitters 1 and 2 (brown)	Power supply output
0LTX12	48	0VDC light curtain emitters 1 and 2 (brown)	Power supply output
NO: Normally Open – NC: Normally Closed			

Tab. 6 Full connection list

The following paragraphs deal with the wiring of each single function (Edm, Muting ...) in more detail.

4.6. Dip-Switches Setup

At control unit top part you will find two units made up of 8 Dip-Switches each: SG-BWS-T4-MT safety rating requires installation of two switches for setting up each function, so that **the setup defined for the first unit shall be set even for the second unit.**

Please note that the two units layout is deliberately antisymmetric: the 1st switch of the right-hand unit corresponds to the last one of the left-hand unit. Such a layout requires a higher awareness when selecting a setup that might directly affect system safety.



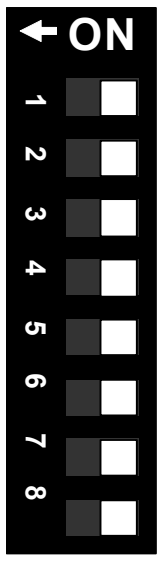





The table below is a list of possible settings selectable through the 8 Dip-Switches available.

	DIP	PURPOSE	OFF (Default)	ON
	1	ENABLE EDM	ENABLED	DISABLED
	2	RESET MODE	AUTOMATIC	MANUAL
	3	MUTING TIME-OUT	10 MINUTES	INFINITY
	4	MUTING DIRECTION	T	L
	2	TRIGGER OVERRIDE	LEVEL	FRONT
	6	MUTING SELECTION	See table below	
	7	MUTING SELECTION		
	8	MUTING SELECTION		

Tab. 7 Dip-Switches configuration

Datalogic Automation supplies the control unit in the “Default” setup (all switches OFF).

The Dip-Switches 6-7-8 allow user to couple the single devices to the 2 muting channels available on the SG-BWS-T4-MT.

DIP-SWITCH SETUP	PHOTOCELLS		LIGHT CURTAIN 1	LIGHT CURTAIN 2
	SET 1-2	SET 3-4		
000 	A		A	A
001 	A		A	B
010 	A		B	B
011 	-		A	B
100 	A		B	-
101 	-		A	A
110 	A		-	-
111 	A	B	-	-

0=OFF, 1=ON, A(B)= Device associated to channel A(B)
 Default setting: 000

Tab. 8 Sensors matched to muting channels



Activating a channel muting involves temporarily suspending the safety function of all devices associated to it. Extreme care is hence required when associating channel to devices: any dangerous settings shall be avoided.

Please refer to “Application with eight sensors on two separate channels” under paragraph 4.10 for an example of muting channels setup.

4.7. Safety light curtains connections

1, 2 or no safety light curtains can be connected to the SG-BWS-T4-MT. Connections required for installing 2 light curtains:

SIGNAL	CONTACT	CONNECTION
OSSD11	41	OSSD 1 output of light curtain 1 (grey)
OSSD21	42	OSSD 1 output of light curtain 2 (grey)
24LRX12	43	24V power for light curtain receivers 1 and 2 (brown)
0LRX12	44	0V power for light curtain receivers 1 and 2 (brown)
OSSD12	45	OSSD 2 output of light curtain 1 (pink)
OSSD22	46	OSSD 2 output of light curtain 2 (pink)
24LTX12	47	24V power for light curtain emitters 1 and 2 (brown)
0LTX12	48	0V power for light curtain emitters 1 and 2 (brown)

Tab. 9 Light curtains connections

N.B.: If not both safety light curtain are connected, unutilized OSSDxx contacts must be bridged to 24VDC. On missing or wrong connection the control unit will stay blocked showing the pertinent error message.

If both safety light curtains are not connected, it is necessary to make a jumper to connect the **OSSDxx contacts not in use to 24VDC**.

The diagram below shows an example of connection of just one safety light curtain.

It is recommended to comply with the specified connections for emitter and receiver in order to obtain the best load balancing.

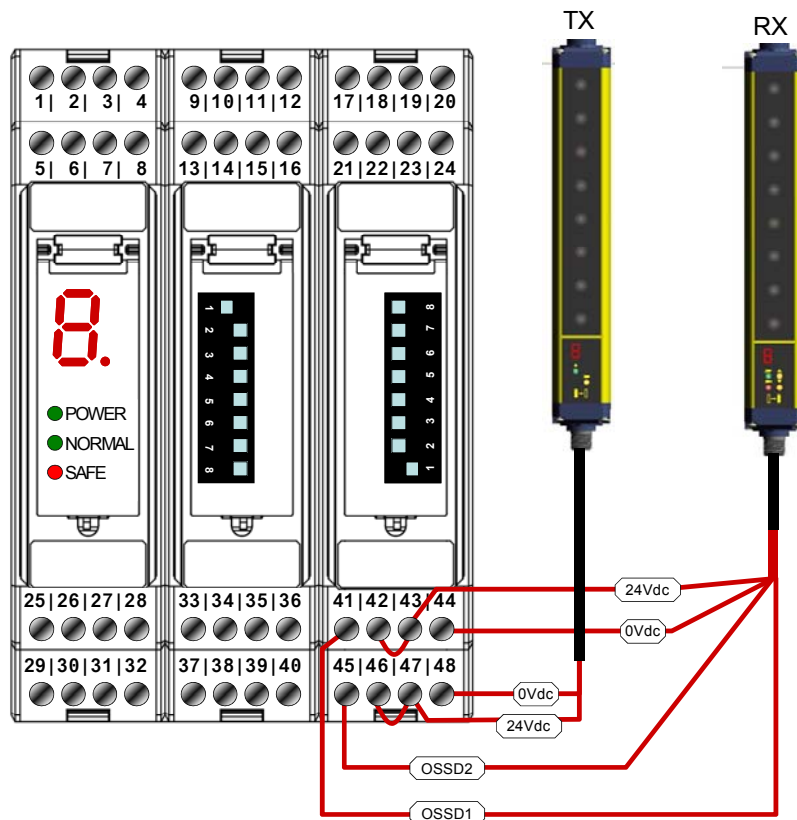

Fig. 19 Safety light curtains connection



It is necessary to connect both OSSD outputs of each light curtain: in case of failed or wrong connection, the control unit shall lock out and display the relevant error code.

Please refer to the relevant manual for instructions on how to connect the light curtain cables not used for operation with SG-BWS-T4-MT.

4.8. Safety photocells connection

0 to 4 safety photocells can be connected to the SG-BWS-T4-MT.
Connections required for installing 4 photocells:

SIGNAL	CONTACT	CONNECTION
RX1	25	PNP output of receiver photocell 1 (black)
RX2	26	PNP output of receiver photocell 2 (black)
RX3	27	PNP output of receiver photocell 3 (black)
RX4	28	PNP output of receiver photocell 4 (black)
TX1	29	TEST of emitter photocell 1 (black)
TX2	30	TEST of emitter photocell 2 (black)
TX3	31	TEST of emitter photocell 3 (black)
TX4	32	TEST of emitter photocell 4 (black)
24VRX12	33	24VDC power for photocell receivers 1 and 2 (brown)
0VRX12	34	0VDC power for photocell receivers 1 and 2 (blue)
24VRX34	35	24VDC power for photocell receivers 3 and 4 (brown)
0VRX34	36	0VDC power for photocell receivers 3 and 4 (blue)
24VTX12	37	24VDC power for photocell emitters 1 and 2 (brown)
0VTX12	38	0VDC power for photocell emitters 1 and 2 (blue)
24VTX34	39	24VDC power for photocell emitters 3 and 4 (brown)
0VTX34	40	0VDC power for photocell emitters 3 and 4 (blue)

Tab. 10 Safety photocells connections

If not all 4 photocells are installed, it is necessary to make a jumper to connect the set of TXn-RXn contacts not in use.
The diagram below shows an example where two sets of photocells are connected.

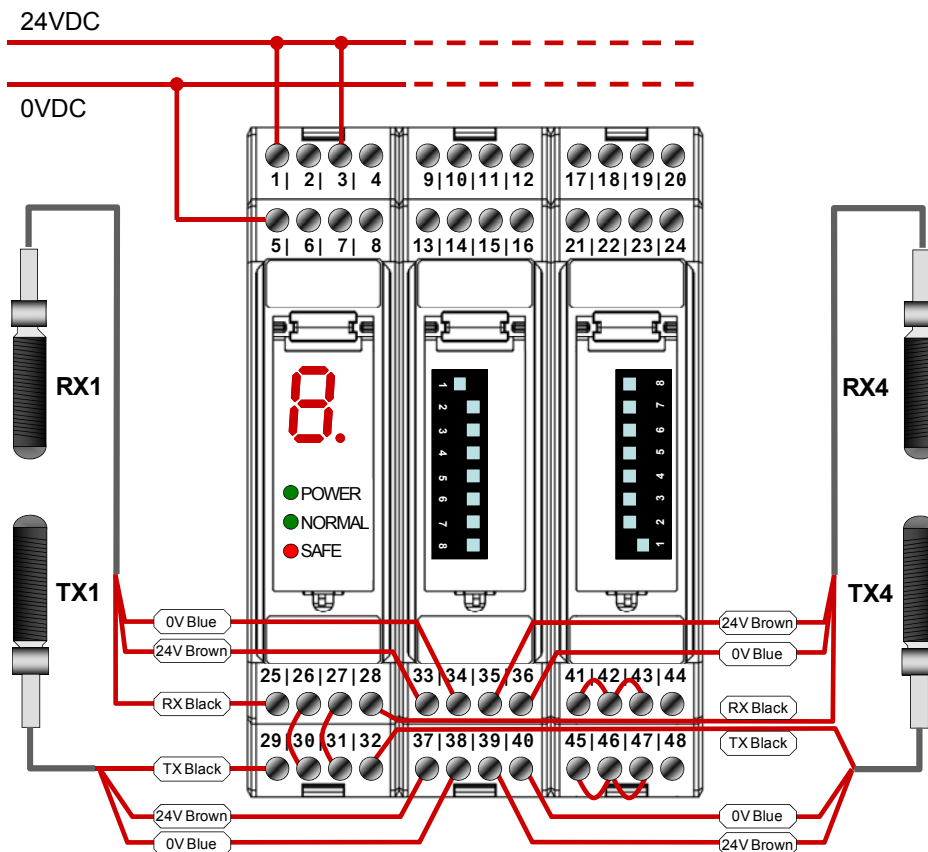

Fig. 20 Safety photocells connection

Photocell connectors are hard-wired as follows:



4.9. Connecting the external relays and EDM

If you choose to use external relays instead of the ones coming with the SG-BWS-T4-MT, just make connections as shown below.

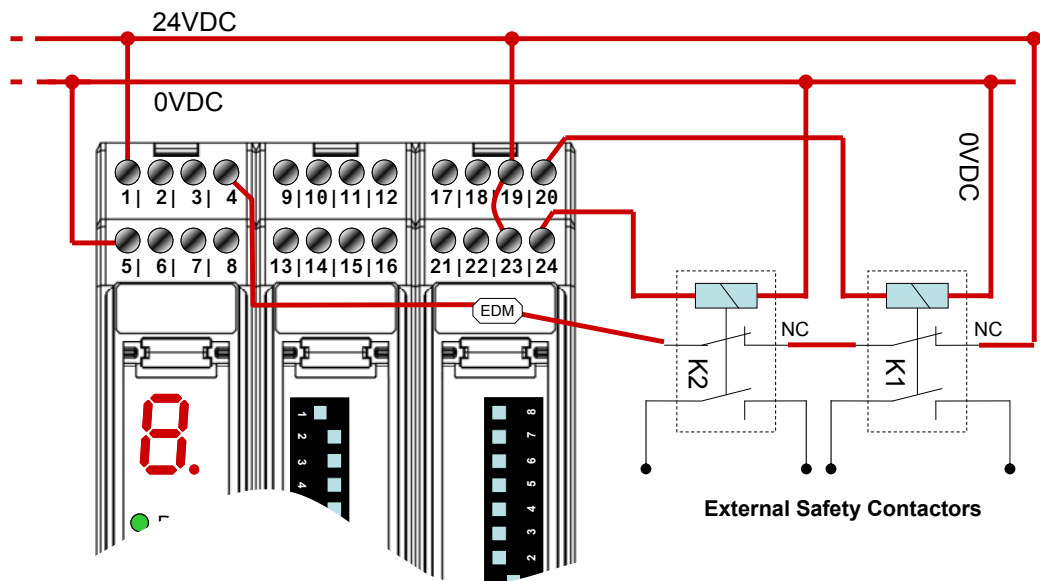

Fig. 21 EDM connections

External devices monitoring (EDM) checks whether the relays (or other control devices) have really opened the power circuit due to a dangerous condition detected by the safety sensors. This function monitors normally closed contacts upon SAFCN status change.

EDM function is activated by duly setting Dip-Switch 1. Activation is confirmed by the decimal point (dot) being displayed on control unit screen.

If EDM is not used, it will be necessary to leave terminal 4 disconnected or fixed to 0V (see 4.3).

SAFCNs STATE

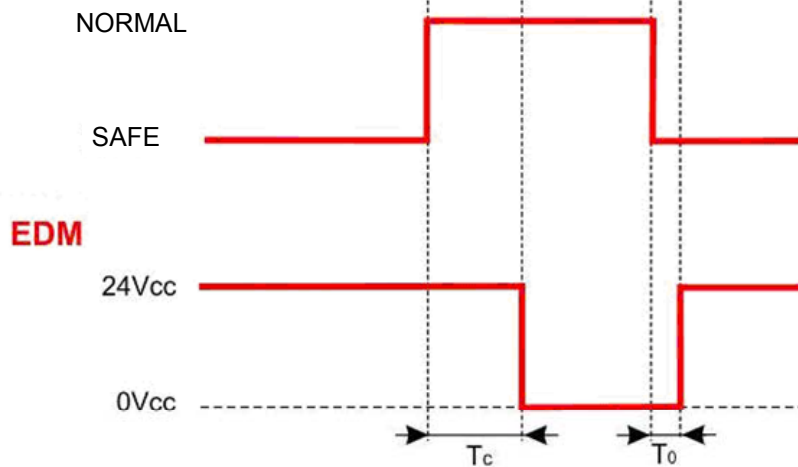

T_c ≥ 350 msec: time after SAFCN OFF-ON switch when EDM test is performed.
 T₀ ≥ 100 msec: time after SAFCN ON-OFF switch when EDM test is performed.

Fig. 22 EDM Timings

To exploit the EDM function available in the SG-BWS-T4-MT system, you simply have to connect in series the two NC contacts of the external relays, then connect the free ends respectively to 24V and contact 4 of control unit, as shown in the above diagram.

4.10. Reset mode and connection of the Start push-button

The interruption of a beam due to an opaque object causes the opening of SAFCN outputs and the stop of the safety control unit (SAFE condition, ● SAFE).

ESPE standard operation can be reset (SAFCN safety contacts closing, NORMAL OPERATION condition, ● NORMAL) in two different ways:

- **Automatic reset:** After its activation ESPE resets to standard operating condition once the object has been removed from the controlled area.
- **Manual reset:** After its activation, ESPE resets to standard operating condition only once the reset function has been enabled and provided that the object has been removed from the controlled area. This condition determines interlock status, pointed out on the display by the relevant warning (see section 6 “Diagnostics and warnings”). **The reset command will only be effective if button is held for over 0.5s but less than 5s.**

Automatic or manual reset mode is selected by duly setting Dip-Switch 2 (see 4.4 “Dip-Switches Setup”).



Carefully assess risk conditions and reset modes. In applications protecting access to dangerous areas, the automatic reset mode is potentially unsafe if it allows the operator to pass completely beyond the sensitive area. In this case, manual resetting is required.

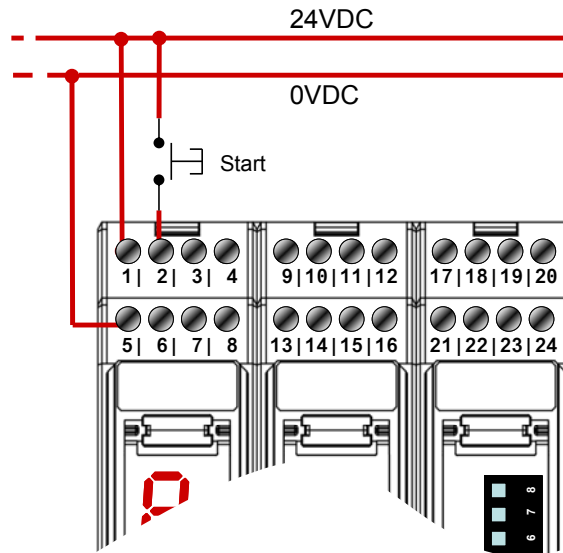

Fig. 23 Start button connection

Reset control shall be output by a suitable push-button with NO contact towards 24VDC, as shown in the above diagram.

The **START** signal is active high.



Carefully spot the most suitable position for the reset push-button!
Install the reset push-button outside the dangerous area so as it is not possible to activate it from inside the area. The operator shall always be able to see the whole dangerous area whenever activating the reset push-button.

4.11. Connection of the Test/Reset push-button

The Test push-button temporarily disables beam emission in order to check switching to SAFE status. This function can be activated by opening (for at least 0.5 seconds) an NC outer contact (TEST push-button).

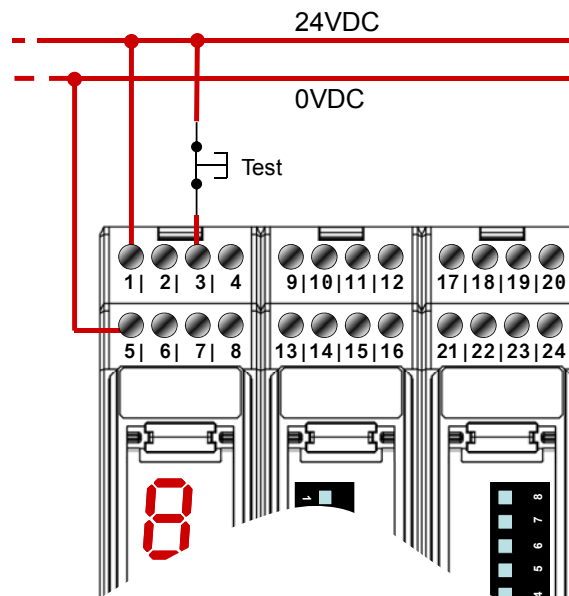

Fig. 24 Test/Reset switch connection

The **TEST** signal is active low.

When this function is activated, ESPE switches to SAFE status and displays the relevant warning (see section 6 “Diagnostics and warnings”).

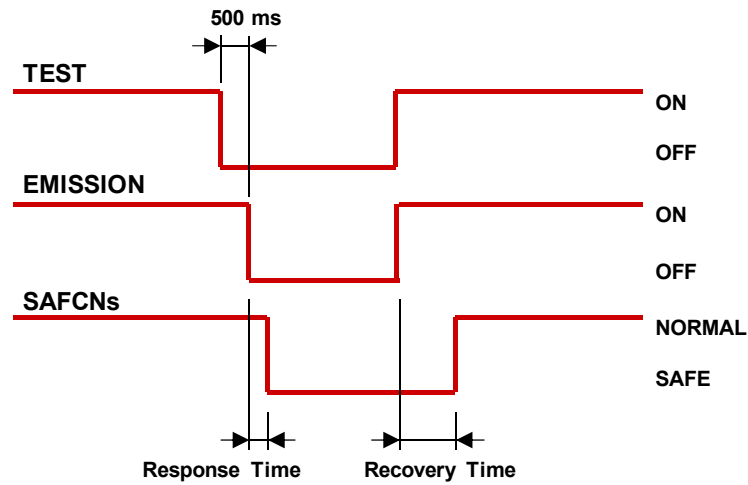

Fig. 25 Test function timings

• **Reset function**

The same push-button can be used to reset the system after a lockout and the relevant error warning. Hold the push-button for **at least 5s** to activate the **reset function**.

If the push-button is held depressed when device is being turned on, the control unit switches to “alignment” mode: please refer to paragraph 5.2 “Safety devices alignment”.

The RESET signal is active low.

4.12. Muting function and relevant connections

The Muting function allows a temporary suspension of the safety function for one or more sensors in order to carry out certain periodical operations avoiding to stop machine operation.

There are two separate muting channels, hereinafter referred to as A and B, and it is possible to match them with various devices according to how the Dip-Switches 6,7,8 are set (see 4.4 “Dip-Switches Setup”).

Activation of the Muting function for a certain channel does not interrupt the safety function on the other channel: if a sensor beam on the active channel is interrupted, the ESPE opens SAFCN outputs (● **SAFE**)

As required by applicable standards, the control unit is equipped with two inputs for activating the muting function in every channel.



Duly connect the Muting sensors in order to avoid that incorrect positioning might lead to unwanted Muting requests. Nevertheless it shall be noted that the Muting function always represents a way forcing the system, and shall hence be used with care.

4.12.1. *Muting function dynamic disabling:*

It is possible to dynamically enable or disable the muting function, during SG-BWS-T4-MT operation: if function is disabled, the control unit shall keep the safety function active even in case of a valid muting request.

Two enabling inputs are provided, each of them refers to one muting channel.

Muting function is enabled with signal low (open contact) to the relevant terminals, as indicated below.

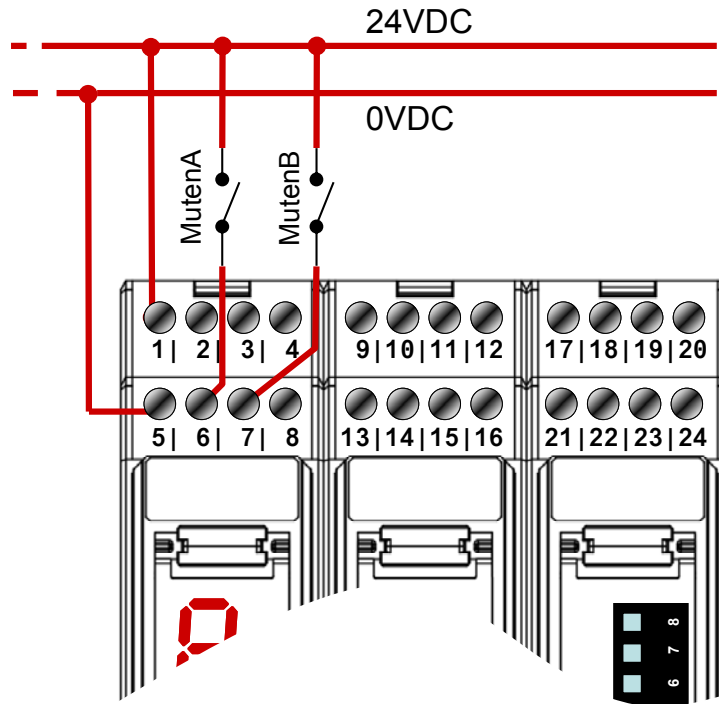

Fig. 26 Muting enabling switches connection

4.12.2. *Muting warning devices:*

To use the Muting function it is also required to connect the external Muting warning (lamp) since control unit would lock out if it is missing. One lamp shall be used per channel. If device is preset for use of just one channel, both warning devices are associated to it: in this way, failure of one of the lamps would not lock out system operation.



If you wish to use just one warning device for the single channel mode, it is possible to connect to terminals 21 and 22 a 150 Ohm resistor with power not lower than 7 W. However, in case of warning device failure, the device does not lock out but only shows a warning on the display and on the relevant output as described below. Therefore, we recommend using two warning devices.

ALLOWED LAMP TYPES	
FILAMENT	24V, 40mA min (1W) - 300mA max (7W)
LED	24V, 40mA min (1W) - 300mA max (7W) respect polarity suggested below

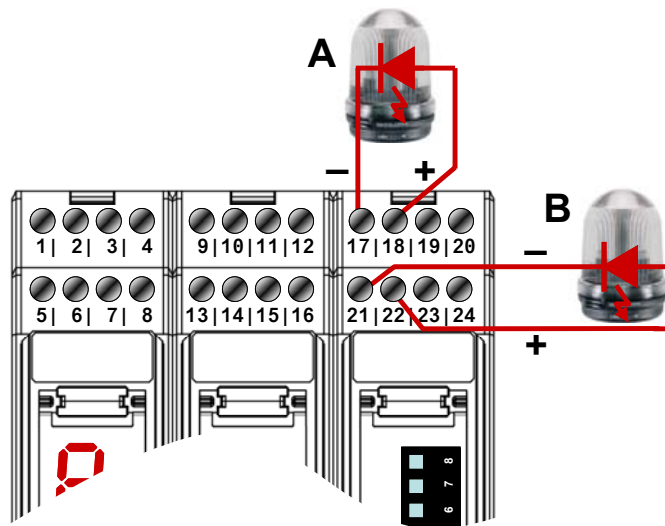

Fig. 27 Muting signalling devices connection



The external light device indicating active Muting condition shall be so positioned as to be always visible by all operators.

4.12.3. *Lamp failure warning:*

In case of warning device failure or if it is missing (of both when used in single-channel mode), the control unit will lock out and display the relevant error code. SG-BWS-T4-MT is also equipped with a suitable **warning output** (terminal 8) that activates when one or both warning devices have failed. This output supplies approx. 24V with maximum load of 25mA, upon activation.

4.12.4. Muting applications and sensors connections:

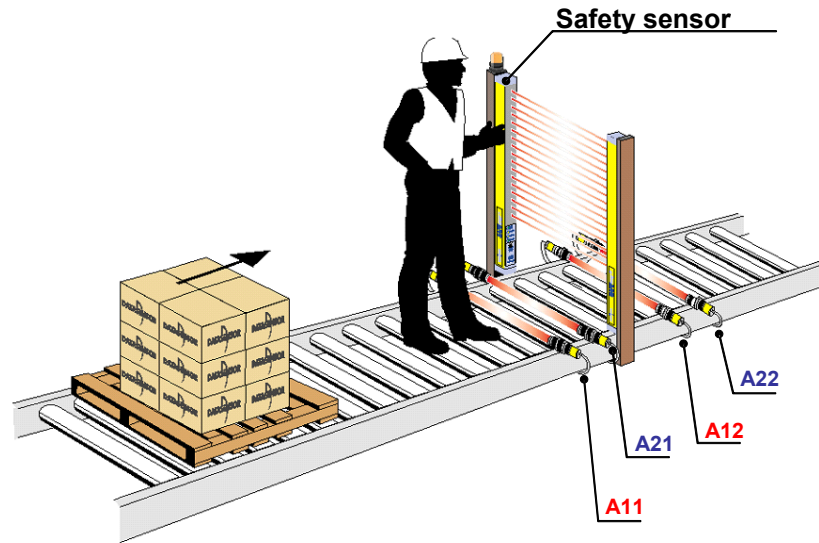

Fig. 28 Muting: typical application

The figure shows a typical muting application: a protection installed on a conveyor belt that shall allow passage of a package, but not of any person. The safety sensor connected to SG-BWS-T4-MT temporarily suspends its function after receiving the correct sequence for activation of sensors A11, A21, A12, A22. These sensors might be optical, mechanical, proximity ones or else, with closed contact when object to be detected is present.

Application with eight sensors on two separate channels:

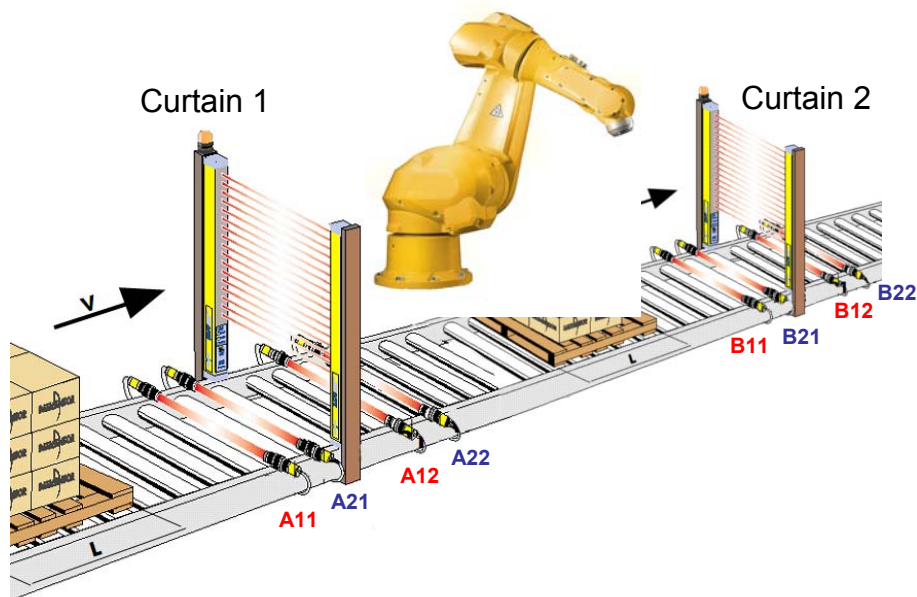

Fig. 29 Muting: 8 sensors application

Thanks to its two separate muting channels, **SG-BWS-T4-MT can accept the muting request output by A_{xx} sensors without interrupting the safety function on light curtain 2.** To implement such setup, user simply needs to match light curtain 1 to channel A and light curtain 2 to channel B (Dip-Switches 6-7-8 set to 0-1-1), then connect the sensors A_{xx} and B_{xx} as shown below. The muting function can also be activated on separate channels by using safety photocells. Tab. 8 shows possible combinations between muting channels and safety sensors.

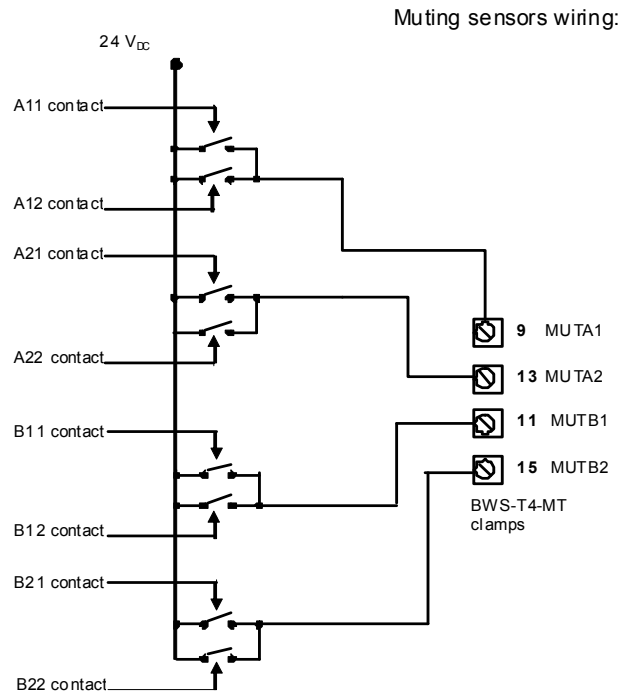

Fig. 30 Muting: 8 sensors application connections

Muting can be activated in both directions or just in one direction: the Dip-Switch 4 selects T or L (see 4.4), while sensors layout determines allowed direction(s).

4.12.5. Uni-directional (type L) muting – 2 sensors

Muting can be activated in both directions or just one: the Dip-Switch 4 selects T or L (see 4.4), while sensors layout determines allowed directions.

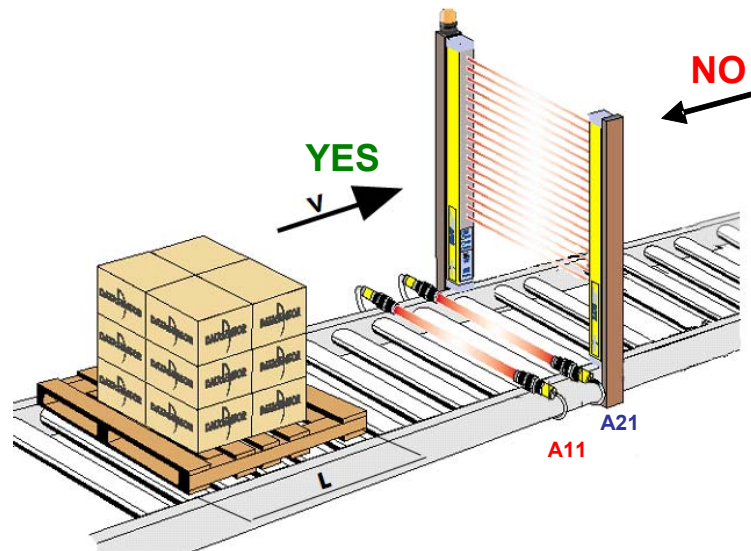

Fig. 31 Uni-directional muting

When set for L-type muting, the system will accept muting request **only** if the sensors activation sequence is **A11**→**A21**; if it is not so, the safety function stays active and machine is stopped.

When set for L-type muting, muting time is automatically calculated by the control unit as follows:

$$T_{\text{Muting}} = 2 \cdot (t_{A21} - t_{A11})$$

Where t_{A21} and t_{A11} are the time instants when sensors A21 and A11 are interrupted, respectively.

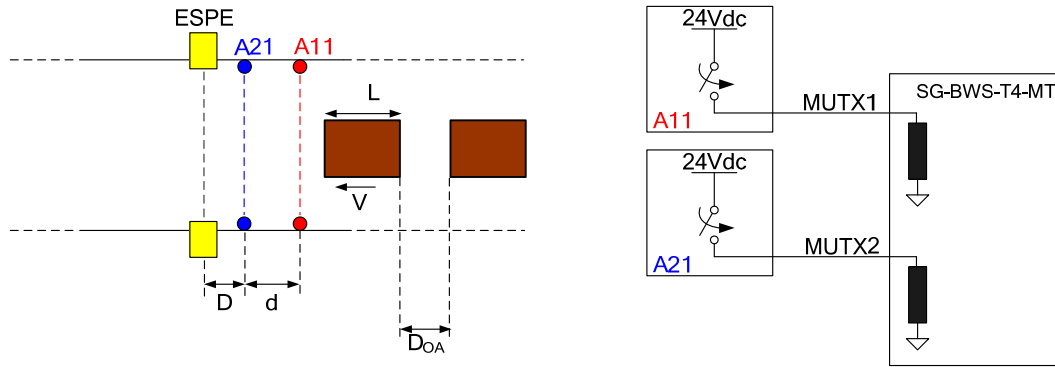

Fig. 32 connessione muting L

Simbolo	unità	Formula	Min	Typ	Max	Description
V	cm/s			20		Speed of the object enabling the Muting function as it passes between the sensors.
L	cm	$> d$	d			Size of the object enabling the Muting function as it passes between the sensors.
d	cm	$0.1 * V < d < L$		20	L	Recommended distance between sensors A21 and A11 for the correct enabling of the muting function.
T12	s	$= (t_{A21} - t_{A11}) = d / V$	0.1	1	4	Time between enabling of A11 and enabling of A21.
t _{Moff}	s	$= 2 * T_{12}$	0.2	2	8	Time, in relation to the disabling of the A11 sensor, after which the Muting function is disabled and the light curtain resumes standard operation.
D	cm			8		Distance between ESPE and A21 sensor.
D _{OA}	cm	$> 2 * d$				Distance to be maintained between two consecutive objects for the correct operation of the Muting function.

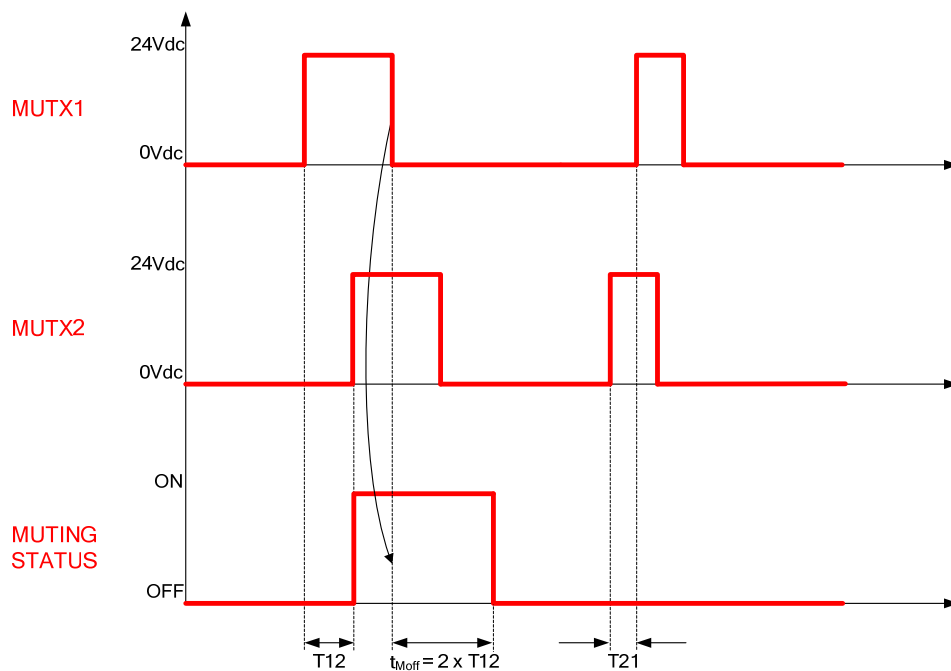

Fig. 33 muting L timings

4.12.6. Bi-directional (type T) muting – 2 or 4 sensors

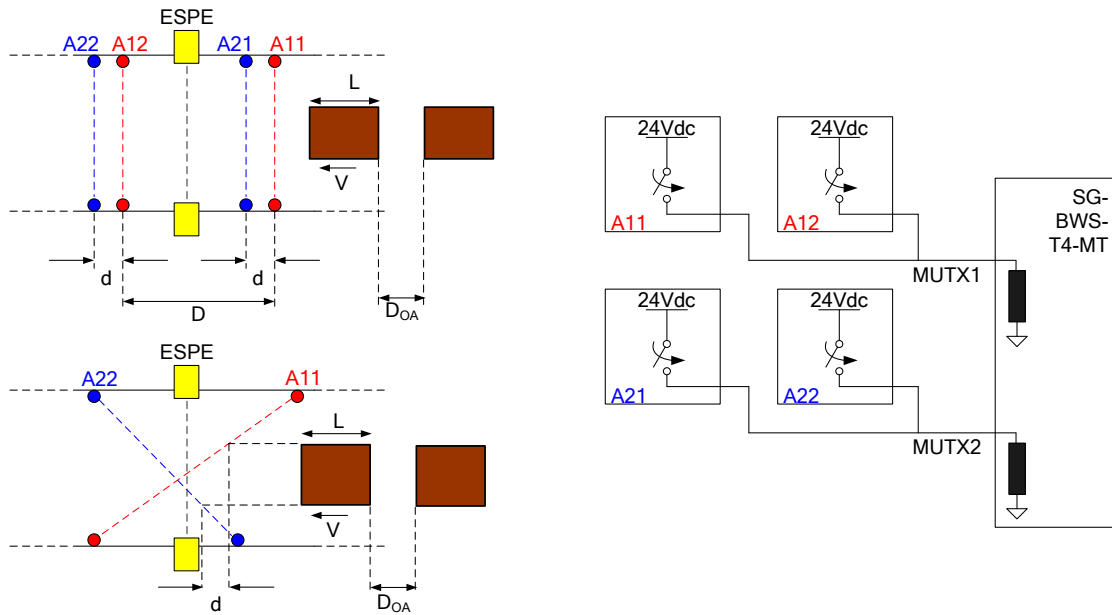

Fig. 34 muting T connection

Symbol	Unit	Formula	Min	Typ	Max	Description
V	cm/s			20		Speed of the object enabling the Muting function as it passes between the sensors.
L	cm	$> D$	D			Size of the object enabling the Muting function as it passes between the sensors
d	cm	$> 0.1 * V$		20		Recommended distance between sensors A21 and A11 for the correct enabling of the muting function.
T12	s	$= (t_{A21} - t_{A11}) = d / V$	0.1	1	4	Time between enabling of A11 and enabling of A21.
D	Cm	$< L$			L	Distance between A11 and A12 sensors
DOA		$> d + D$				Distance to be maintained between two consecutive objects for the correct operation of the Muting function.

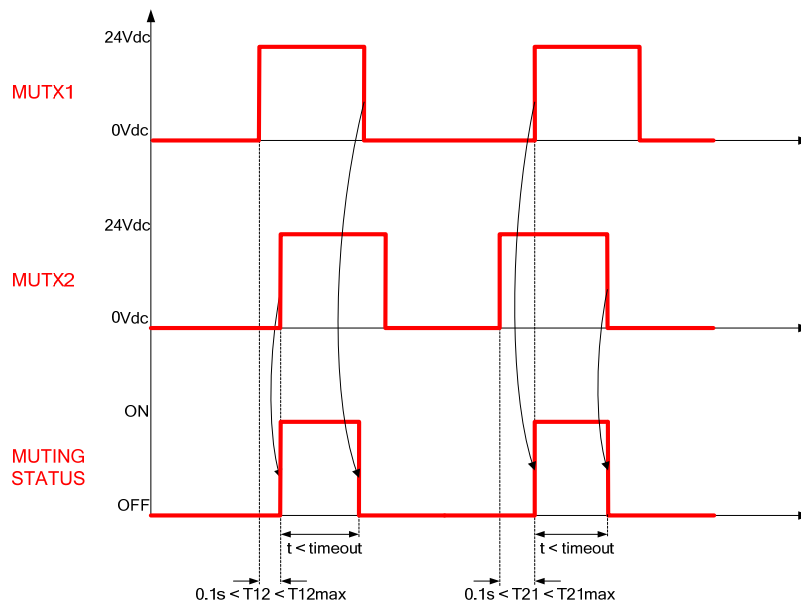

Fig. 35 timings muting T

4.12.7. Muting Time-out

Using the Dip-Switch 3 (see 4.4) you can set a **10min** time-out or **infinity**, i.e. the maximum available setting for the muting function duration.



Infinity Time-Out setting does not comply with EN 61496-1 requirements. Carefully assess all risks and take any required precautions if you decide to use this setting.

4.13. Connecting the Override pushbuttons

The Override function forces safety function disabling in case it is required to start the machine when one or more beams are interrupted by some material. The goal being to clear off the controlled area removing any material build-up in front of photocells due, for instance, to machine cycle fault.

Say that a pallet has stopped in front of one or many optics, the conveyor belt can not be restarted since the control unit detects one or more beams interrupted and will not close the output relays, i.e. not allow clearing of the controlled area.

Using the Override function will allow clearing of the area.

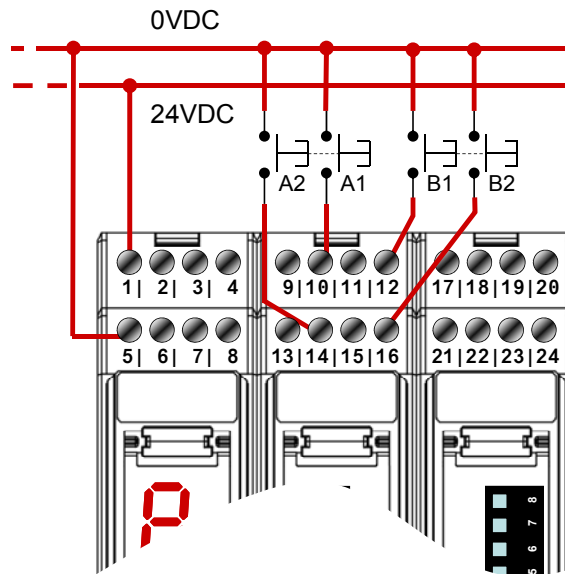

Fig. 36 Override switches connections

The Override contacts shall be connected by means of push-buttons normally open toward 24VDC. OVRA1 and OVRA2 signals control the Override on the devices associated to the Muting A channel; vice versa, OVRB1 and OVRB2 signals control the Override on the devices associated to the Muting B channel.



The Override switches shall be set so that the operator can see the whole controlled area when activating the function, as well as outside such area.

Override can only be activated under certain conditions: outputs shall be in SAFE status and at least one Muting sensor beam shall be interrupted. In such conditions, the control unit will display a message warning about the possibility to activate the Override function (see section 6 “Diagnostics and warnings”).

• **Activating the Override function**

When the display shows the above-indicated warning, **press both buttons** associated to the channel for which Override shall be activated. Once function has been activated, the display shows three overlapping segments and the Muting lamp flashes to indicate safety function disabling. The Override function can last for a maximum of 120 seconds; after this time, it is disabled even if buttons are still depressed.

Activation of the Override function for a certain channel does not interrupt the safety function on the other channel: if a sensor beam on the active channel is interrupted, the ESPE opens SAFCN outputs (● **SAFE**)

• **Edge or Level Override**

Using the Dip-Switch 5 user can set one of two different Override modes:

level: the function is kept active as far as both push-buttons are depressed. The Override is immediately disabled when one push-button or if muting sensors beam is no longer interrupted.

edge: the function is kept active even after the push-buttons are released and is disabled after the 120s time-out or as soon as all muting sensors beams are no longer interrupted.



In such a case reactivation of normal operation could be not monitored by an operator thus becoming virtually dangerous. Please consider any possible risk and take necessary counter-measures if edge override is selected.

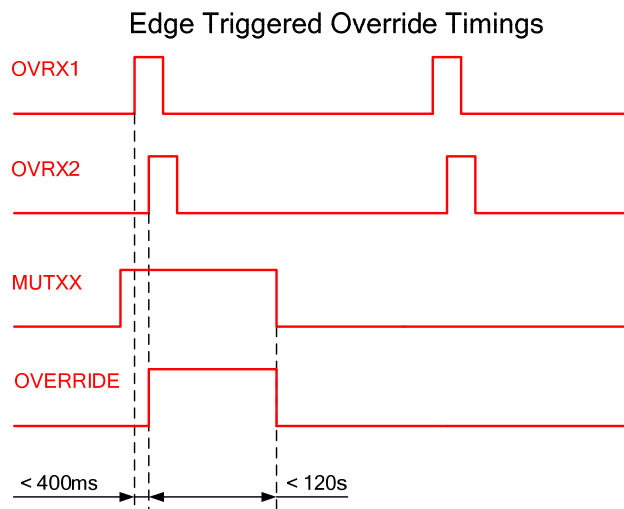
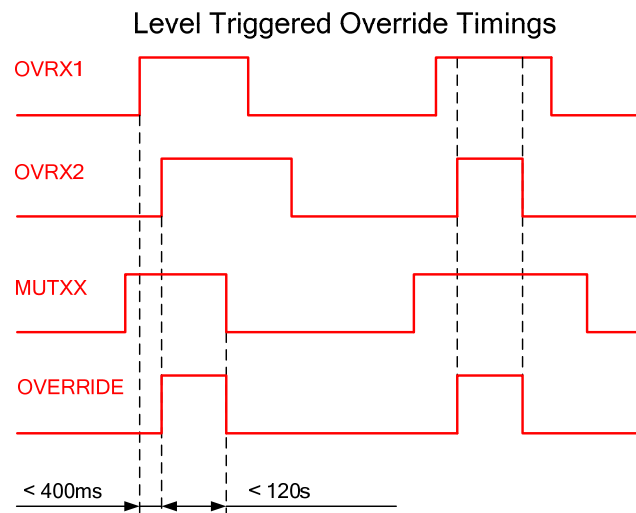

• **Override on L type muting**

When monodirectional muting is selected (L type) Override function is deactivated after all relatives safety sensors get free or after the 120s timeout.

Override timings on L type muting

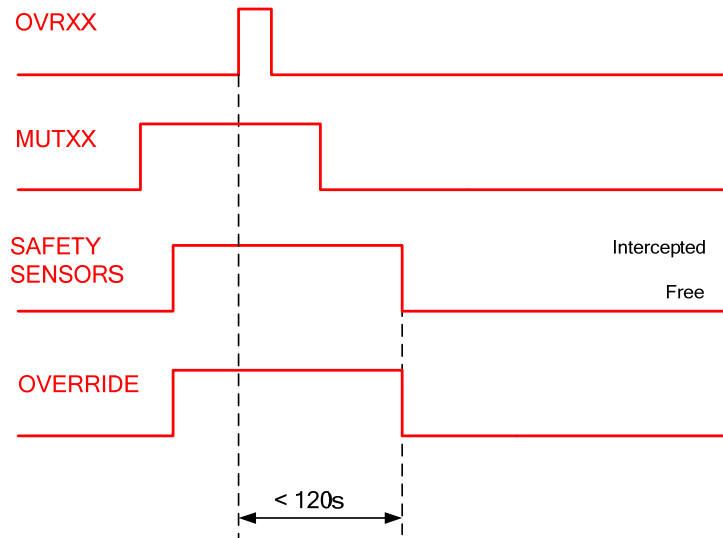

5. COMMISSIONING



Before commissioning a system protected by SG-BWS-T4-MT it shall be inspected and checked by a qualified technician who shall state its suitability. Please refer, for further details on this subject, the instructions given under paragraph 3.1 “Safety information”.

5.1. Screen indications upon switch-on

As soon as control unit is powered, all 7 display segments will turn on. The display will then switch off and all segments are quickly activated one after the other. The display will then switch off again meaning that the device is ready for use. When the display does not switch off, there is an error in the device (see section 6 “Diagnostics and warnings”).

The meaning of displayed values is as follows:

Display	Meaning
	7-segment display test routine. All segments are activated one after the other.
Nothing on screen (only decimal point if EDM on)	The device is ready for use
Any other view	System failure. Refer to section 6 “Diagnostics and warnings”

Tab. 11 Startup visualization sequence

5.2. Alignment mode

Once all components are in place and connected, emitters and receivers shall be mutually aligned.

In alignment mode, the SAFCN safety outputs are open. The alignment mode and relevant procedure are described here below:

- Cut off control unit power supply.
- Power on the control unit while holding pressed Test button (Test contact open)
- The 7-segment display shows the first device to be aligned (Photocells 1-4, light curtains 5-6), release Test button.
- Align the indicated device until display will indicate the following device to be aligned or alignment completed warning (flashing).

When alignment is completed, cut off control unit power, ensure Test button is released (contact closed) and restore control unit power. The control unit will run the initial test routines and display a countdown, the display will then turn off and the control unit will switch to NORMAL OPERATION status (**NORMAL**).

Now carry out the following inspections:

- The ESPE stays in **SAFE** mode during photocells and light curtains beam interruption using the suitable “Test Piece”, along the entire protected area.
- Enabling the TEST function, the SAFCN outputs should open (**SAFE** and the controlled machine stops).
- The response time upon machine STOP (including response time of the ESPE and of the machine) is within the limits defined for the calculation of the safety distance (see section 3 “Installation”).
- The safety distance between the dangerous areas and the safety sensors is in accordance with the instructions included in section 3 “Installation”.
- Access of a person between sensors and machine dangerous parts is not possible nor is it possible for him/her to stay there.
- Access to the dangerous area of the machine from any unprotected area is not possible.

During alignment or normal operation, make sure that the photocells connected to the same or other units do not interfere with each other. Should you find interference, change their position, for instance you could set some emitter sets on the side of the other receivers. In case of interference, the control unit will lock out and display the relevant error code.

N.B.: For each check about light curtains see all the sentences into user manual

6. DIAGNOSTICS AND WARNINGS







SG-BWS-T4-MT is equipped with a user interface featuring 3 LEDs and a 7-segment display.





LED	Indication
● Power	Device is powered correctly
● NORMAL	No danger: safety outputs closed
● SAFE	Danger or fault: safety outputs open
	The 7-segment display shows detailed information on control unit current status

Tab. 12 Signalling interface

The table below specifies all possible screen indications and the system status or failure associated to each of them.





6.1. Normal operation signalling



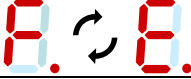

INDICATION	STATUS	DESCRIPTION	WHAT TO DO
● POWER ○ NORMAL ● SAFE 	Alignment	The display shows the first device to be aligned and then the others in a sequence (1 to 6).	Align the safety devices 1..4: Photocells 5,6: Safety light curtains
● POWER ○ NORMAL ● SAFE 	Alignment	All connected devices are aligned.	Close the Test contact (Pin 3) and restart the control unit to switch to normal operation
● POWER ○ NORMAL ● SAFE 	SAFE	The indicated safety device beam is interrupted. If many devices are in this status, the first one is indicated, then the others in a sequence (1 to 6).	Clear the area or check device connections
● POWER ● NORMAL ○ SAFE 	NORMAL OPERATION	The device is in normal operating conditions and monitored area is safe.	
● POWER ○ NORMAL ● SAFE 	SAFE	The Override function can be activated on channel A, B or both.	Perform the suitable sequence to activate the Override or clear off any objects interrupting safety sensors beam
● POWER ● NORMAL ○ SAFE 	NORMAL OPERATION	The Muting function is active on channel A, B or both. The muting indicator is flashing.	
● POWER ● NORMAL ○ SAFE 	NORMAL OPERATION	The Override function is active on channel A, B or both. The muting indicator is flashing.	

INDICATION	STATUS	DESCRIPTION	WHAT TO DO
<ul style="list-style-type: none"> ● POWER ● NORMAL ○ SAFE 	NORMAL OPERATION	One of the two muting lamps is disconnected or faulty (only one muting channel is active).	Change the faulty lamp. It is not necessary to restart. Switch device off and back on.
<ul style="list-style-type: none"> ● POWER ✱ NORMAL ● SAFE 	Interlock	Waiting for the START command in manual reset mode	Push reset control
<ul style="list-style-type: none"> ● POWER ●/○ NORMAL ○/● SAFE 	NORMAL OPERATION/ SAFE	The decimal point indicates that the EDM function is active (see 4.7)	
<ul style="list-style-type: none"> ● POWER ○ NORMAL ● SAFE 	SAFE	TEST push-button pressed (contact 3 open)	Check TEST push-button connections (see 4.9)

Tab. 13 Normal operation signalling

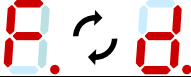
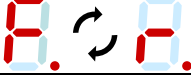
6.2. Failure state signalling

INDICATION	STATUS	DESCRIPTION	WHAT TO DO
<ul style="list-style-type: none"> ○ POWER ○ NORMAL ○ SAFE 	Off	Power disconnected or inner fuse blown due to overload.	Check power supply. If error persists, please contact the Technical Service.
<ul style="list-style-type: none"> ● POWER ○ NORMAL ● SAFE 	INTERNAL DEVICE MONITORING FAILURE LOCKOUT	Internal relays contacts monitoring test has failed.	Reset the control unit (see 4.6). If error persists, please contact the Technical Service.
<ul style="list-style-type: none"> ● POWER ○ NORMAL ● SAFE 	INTERNAL OSSD FAILURE LOCKOUT	Internal OSSD test routine has failed.	Reset the control unit (see 4.9). If error persists, please contact the Technical Service.
<ul style="list-style-type: none"> ● POWER ○ NORMAL ● SAFE 	EDM FAILURE LOCKOUT	EDM test has failed	Check EDM connections (see 4.7) or disable EDM function (see 4.4) if you do not wish to use it.
<ul style="list-style-type: none"> ● POWER ○ NORMAL ● SAFE 	MICRO-PROCESSOR FAILURE LOCKOUT	One of microprocessor tests has failed	Disconnect power supply and reconnect it. If error persists, please contact the Technical Service.

INDICATION	STATUS	DESCRIPTION	WHAT TO DO
<ul style="list-style-type: none"> ● POWER ○ NORMAL ● SAFE 	DIP SWITCHES FAILURE LOCKOUT	The Dip-Switches setting consistency test has failed	Make sure that the settings of the two sets of switches is the same (see 4.4). Reset the control unit (see 4.9). If error persists, please contact the Technical Service.
<ul style="list-style-type: none"> ● POWER ○ NORMAL ● SAFE 	RESTART FAILURE LOCKOUT	Start signal time-out tripped.	Make sure you hold the Start button depressed for less than 5s.
<ul style="list-style-type: none"> ● POWER ○ NORMAL ● SAFE 	SENSOR FAILURE LOCKOUT	Test of indicated safety sensor has failed.	<ul style="list-style-type: none"> - F 1-4: Make sure there is no interference across different photocell sets. - F 5-6: Check light curtains OSSD connections (see 4.5).
<ul style="list-style-type: none"> ● POWER ○ NORMAL ● SAFE 	LAMP FAILURE LOCKOUT	Muting lamp faulty or disconnected.	Change the faulty lamp, then Reset the control unit (see 4.9)
<ul style="list-style-type: none"> ● POWER ○ NORMAL ● SAFE 	OVERRIDE FAILURE	The Override command activation test has failed (push-buttons not pressed at the same time)	Press the Override push-buttons at the same time.

Tab. 14 Failure state signalling

7. PERIODICAL CHECKS AND WARRANTY

7.1. Periodical checks

The following is a list of recommended check and maintenance operations that should be periodically carried out by qualified personnel.

Check that:

- The ESPE stays in SAFCNs disabled state (● **SAFE**) mode during photocells and light curtains beam interruption using the suitable "Test Piece", along the entire protected area.
- Sensors are correctly aligned: by slightly pressing each sensor side, in both directions, the system shall stay in ● **NORMAL** mode
- Enabling the TEST function, the SAFCN outputs should open (● **SAFE** and the controlled machine stops).
- The response time upon machine STOP (including response time of the ESPE and of the machine) is within the limits defined for the calculation of the safety distance (see section 3 "Installation").
- The safety distance between the dangerous areas and the safety sensors is in accordance with the instructions included in section 3 "Installation".
- Access of a person between sensors and machine dangerous parts is not possible nor is it possible for him/her to stay there.
- Access to the dangerous area of the machine from any unprotected area is not possible.
- The ESPE, the sensors and the external electrical connections are not damaged.

The frequency of checks depends on the particular application and on the operating conditions of the safety light curtain.

7.2. Warranty

Datalogic Automation guarantees each brand new SG-BWS-T4-MT system, under standard use conditions, against manufacturing defects in material and workmanship for a period of 36 (thirty-six) months from the date of manufacturing.

Datalogic Automation will not be liable for any damages to persons and things caused by failure to stick to the correct installation modes and device use.

Warranty validity is subjected to the following conditions:

- User shall notify Datalogic Automation the failure within thirty-six months from product manufacturing date.
- Failure or malfunction shall not have been originated directly or indirectly by:
 - Use for unsuitable purposes;
 - Failure to comply with the intended use prescriptions;
 - Negligence, unskillfulness, wrong maintenance;
 - Repairing, changes, adaptations not made by Datalogic Automation personnel, tampering with the device, etc.;
 - Accidents or crashes (even due to transportation or by force majeure causes);
 - Other causes not depending from Datalogic Automation

If the device does not work, send the unit to Datalogic Automation. The Customer is responsible for all transport charges and damage risks or material loss during transport, unless otherwise agreed.

All replaced products and parts become a property of Datalogic Automation.

Datalogic Automation acknowledges no other guarantees or rights apart from the ones expressly specified above. Therefore no claims for damages due to afforded costs, suspension of working activities or other factors somehow linked with product or product parts failure will be accepted.

In case of problems, please contact Datalogic Automation Service Department.

Service Department

Phone no.: +39 051 6765611

Fax no.: +39 051 6759324

8. DEVICE MAINTENANCE

SG-BWS-T4-MT and photocells of the S5, SL5, S300 series do not require any special servicing.

To avoid the reduction of the operative distance, optics protective front surfaces shall be cleaned at regular intervals.

To this end, use soft cotton cloths dampened in water; do not apply too much pressure onto the surface so as not to make it dull.

Please do not use on plastic surfaces or optics:

- alcohol or solvents
- wool or synthetic cloths
- paper or other abrasive materials

8.1. Product disposal

Under current Italian and European laws, Datalogic is not obliged to take care of product disposal at the end of its useful life.

Datalogic recommends to dispose of the product in compliance with local laws or contact authorised waste collection centres.

9. TECHNICAL DATA

• SG-BWS-T4-MT

Electrical data	
Supply voltage:	24 Vdc \pm 15%
Current draw:	3.8 W max
Output contacts:	2 Normally Open Relays, 250VAC 3,6A – 24VDC 3,6A Type: Guided contacts Contacts Material: Alloy Ag+0.2-0.4mm Au Mechanical life: >107 cycles
Response time:	35ms
Safety category:	Type 4 (ref. EN 61496-1) SIL3 (ref. EN 62061) PL e – Cat. 4 (ref IEC 13849-1 2008)
Auxiliary functions:	Restart / Test / EDM / Reset / EDM selection / auto-man selection
Overvoltage cat. Class.:	Cat. II (250 VAC) – Cat. III (24VDC) (ref. EN 50178)
Connections:	Screw terminals
Cables length (for power supply):	50 m. max
Pollution rating:	2
Muting Lamp:	Filament or LED Lamp. 24V, 40mA min (1W) - 300mA max (7W)
Mechanical and environmental data	
Operating temperature:	0...55°C
Storage temperature:	-25...+ 70 °C
Temperature rating:	T6
Humidity:	15...95 % (no condensation)
Mechanical protection:	IP 20 (EN 60529)
Vibrations:	Width 0.35 mm, frequency 10 ... 55Hz; 20 sweep per axis, 1octave/min (EN 60068-2-6)
Shock resistance:	16 ms (10 G) 1,000 shocks per axis (EN 60068-2-29)
Housing material:	Nylon PA66
Weight:	370 g

Tab. 15 SG-BWS-T4-MT technical data

• S5-ST2/ST4, SL5-ST4

For technical details about S5, SL5 series look at pertaining user manual.

• S300

For technical details about S300 series look at pertaining user manual.

10. ORDER DATA

• Control Unit

Component	Description	Code
SG-BWS-T4-MT	TYPE 4 CONTROL UNIT WITH DOUBLE MUTING	957051010

Product	<i>EN ISO 13849-1</i> PL	<i>EN 954-1</i> CAT	<i>EN IEC 61508</i> SIL	<i>EN IEC 62061</i> SIL CL	<i>Prob. of danger failure/hour</i> PFHd (1/h)	<i>Life span</i> T1 (years)	<i>Mean Time to Dangerous Failure</i> MTTFd (years)	<i>Average Diagnostic Coverage</i> DC	<i>Safe Failure Fraction</i> SFF	<i>Hardware Fault Tolerance</i> HFT
SG-BWS-T4-MT	e	4	3	3	1.74E-09	20	428	98.40%	99.03%	1

- **Photocells**

S5 – M18 Tubular

Component	Description	Code
S5-5-G8-62-SG-ST2	S5-5-G8-62-SG-ST2 EMITTER 10/30VDC	952051870
S5-5-F8-92-SG-ST2	S5-5-F8-92-SG-ST2 RECEIVER 10/30VDC	952051890
S5-5-G8-62-SG-ST4	S5-5-G8-62-SG-ST4 EMITTER 10/30VDC	952051910
S5-5-F8-92-SG-ST4	S5-5-F8-92-SG-ST4 RECEIVER 10/30VDC	952051930
SL5-5-G-82-SG-ST4	SL5-5-G-82-SG-ST4 LASER EMETT. 40m M12	952501160
SL5-5-F-92-SG-ST4	SL5-5-F-92-SG-ST4 RIC 40m PNP LIGHT M12	952501170

S300 maxi

Component	Description	Code
S300-PR-5-G00-EX-SG-ST2	TYPE 2 EMITTER M12 CONNECTOR DC	951451320
S300-PR-5-G00-EX-M-SG-ST2	TYPE 2 EMITTER M12 CONN. DC DEFOGGING	951451330
S300-PR-5-F01-OC-SG-ST2	TYPE 2 RECEIVER M12 CONNECTOR DC	951451340
S300-PR-5-F01-OC-M-SG-ST2	TYPE 2 RECEIVER M12 CONN. DC DEFOGGING	951451350
S300-PR-5-G00-EX-SG-ST4	TYPE 4 EMITTER CONNETTORE M12 DC	951451360
S300-PR-5-G00-EX-M-SG-ST4	TYPE 4 EMITTER M12 CONN. DC DEFOGGING	951451370
S300-PR-5-F01-OC-SG-ST4	TYPE 4 RECEIVER M12 CONNECTOR DC	951451380
S300-PR-5-F01-OC-M-SG-ST4	TYPE 4 RECEIVER M12 CONN. DC DEFOGGING	951451390

- **Accessories**

Componente	Descrizione	Codice
SG-DM 150	DEVIATING MIRROR H=150MM	95ASE1670
LMS	MUTING LAMP	95ASE1830
LMS-1	MODULAR MUTING LAMP	95ACC1990
LMS-2	MUTING LAMP - HORIZONTAL FIX	95ACC2000
LMS-3	MUTING LAMP - VERTICAL FIX	95ACC2010

11. OVERALL DIMENSIONS

11.1. SG-BWS-T4-MT

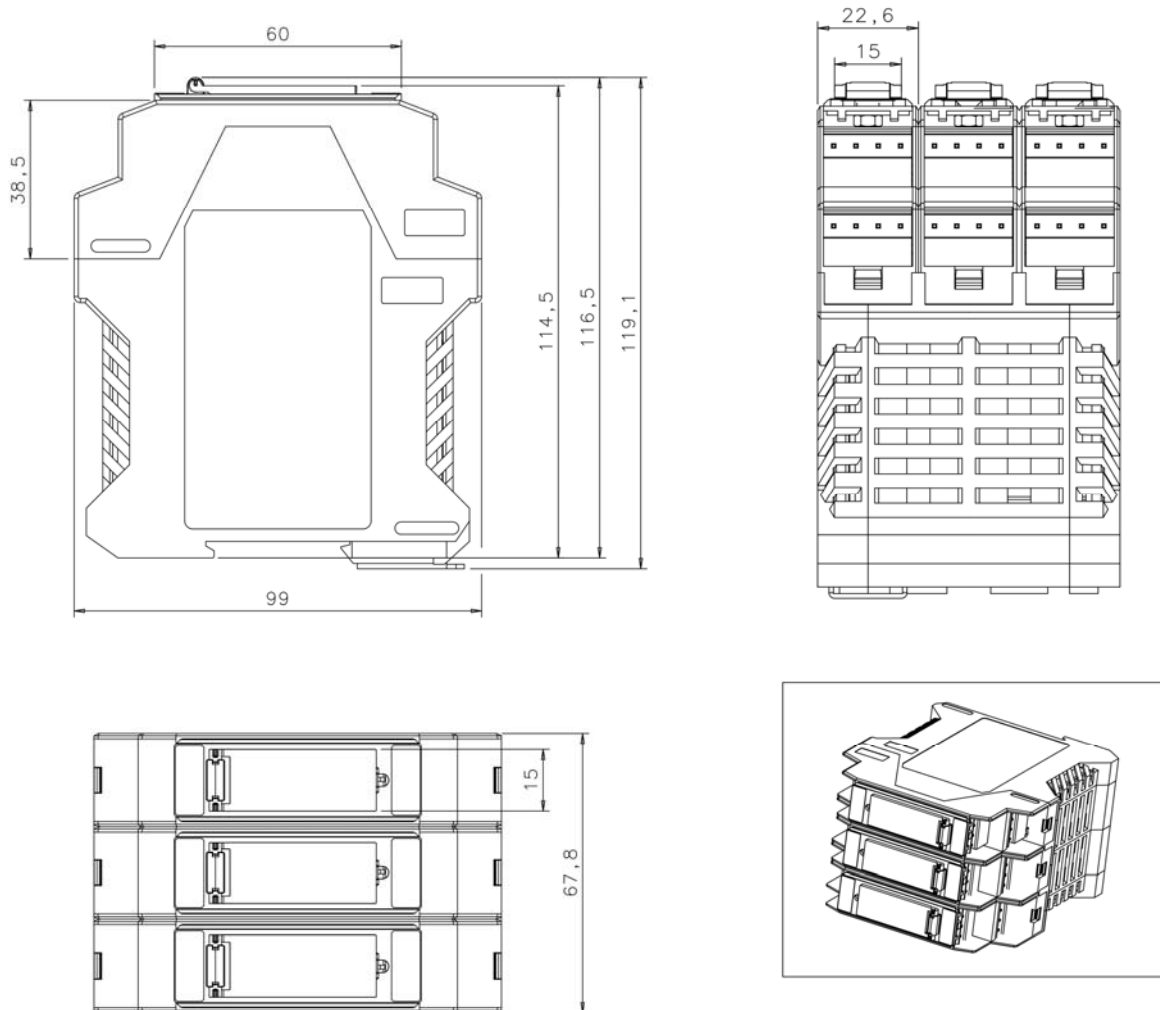

Fig. 37 SG-BWS-T4-MT overall dimensions

11.2. S5-ST2, S5-ST4, SL5-ST4, S300

For overall dimensions of single beam photocells see the relative user manuals.

12. APPENDIX

12.1. FIGURE INDEX:

Fig. 1 SG-BWS-T4-MT Appearance and user interface 2

Fig. 2 Protective Flaps..... 3

Fig. 3 Safety single beam photocells S5,SL5 series (appearance) 4

Fig. 4 S300 series safety photocells 4

Fig. 5 Conveyor protections 5

Fig. 6 Automatic warehouses protection with photocells 6

Fig. 7 Doors control by means of safety photocells 6

Fig. 8 Safety light curtain positioning 8

Fig. 9 Safety Distance 9

Fig. 10 Photocells installation heights for 4 beams protections 10

Fig. 11 Distance from reflecting surfaces..... 11

Fig. 12 Sensors disposal in order to avoid interferences..... 12

Fig. 13 Distance between equal sensors 12

Fig. 14 Safety Control Unit mounting 13

Fig. 15 Deviating Mirros 14

Fig. 16 SG-BWS-T4-MT connection to machine power supply 15

Fig. 17 Minimum connection for function test..... 16

Fig. 18 Connection clamps disposal 17

Fig. 19 Safety light curtains connection 20

Fig. 20 Safety photocells connection 21

Fig. 21 EDM connections 22

Fig. 22 EDM Timings..... 23

Fig. 23 Start button connection 24

Fig. 24 Test/Reset switch connection 24

Fig. 25 Test function timings 25

Fig. 26 Muting enabling switches connection..... 26

Fig. 27 Muting signalling devices connection..... 27

Fig. 28 Muting: typical application 28

Fig. 29 Muting: 8 sensors application..... 28

Fig. 30 Muting: 8 sensors application connections 29

Fig. 31 Uni-directional muting..... 29

Fig. 32 connection muting L 30

Fig. 33 muting L timings 30

Fig. 34 muting T connection 31

Fig. 35 timings muting T 31

Fig. 36 Override switches connections 32

Fig. 37 SG-BWS-T4-MT overall dimensions 44

12.2. TABLES INDEX:

Tab. 1 User manual main contents 1

Tab. 2 Signalling LEDs..... 3

Tab. 3 Photocells signalling..... 4

Tab. 4 Beams height for photocells protections 9

Tab. 5 Minimum connection details for function test..... 16

Tab. 6 Full connection list..... 18

Tab. 7 Dip-Switches configuration..... 19

Tab. 8 Sensors matched to muting channels..... 19

Tab. 9 Light curtains connections..... 20

Tab. 10 Safety photocells connections 21

Tab. 11 Startup visualization sequence 35

Tab. 12 Signalling interface..... 36

Tab. 13 Normal operation signalling 37

Tab. 14 Failure state signalling 38

Tab. 15 SG-BWS-T4-MT technical data 41

