

## S60-PL SERIES INSTRUCTION MANUAL



### CONTROLS

#### OUTPUT LED (S60-PL...B01/C01/F01)

The yellow LED on indicates that the N.O. (normally open) output status is closed.

#### POWER ON LED (S60-PL...B01/C01/F01/G00)

The green LED indicates that the sensor is operating and the laser is active.

#### TRIMMER (S60-PL ...B01/C01/F01)

The trimmer can be used to adjust sensitivity; the operating distance increases turning the trimmer clockwise.

**WARNING:** The trimmer rotation is limited to 270° by a mechanical stop. Do not apply excessive torque when adjusting (max 40 Nmm).

### INSTALLATION

The sensor can be positioned by means of the three housing's holes using two screws (M4x25 or longer, 1.5 Nm maximum tightening torque) with washers.

Various orientable fixing brackets to ease the sensor positioning are available (please refer to the accessories listed in the general catalogue).

The operating distance is measured from the front surface of the sensor optics.

The M12 connector can be oriented at two different positions using the specific fastening spring and rotating the block of 180°.



### CONNECTIONS

The connections are compliant to the EN 60947-5-2 standard.

#### S60-PL...B01/C01/F01

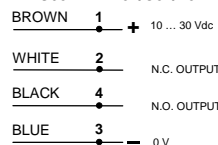

#### S60-PL...G00

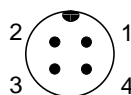
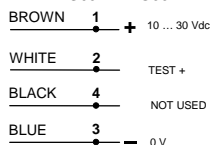

M12 CONNECTOR

### DIMENSIONS

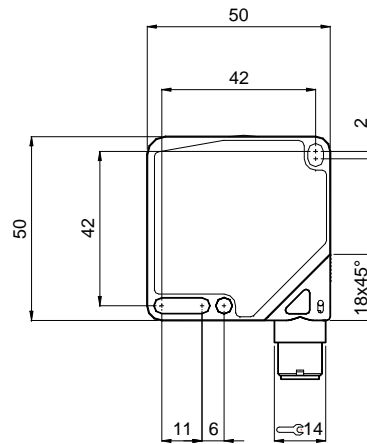

#### S60-PL...B01/C01/F01/G00

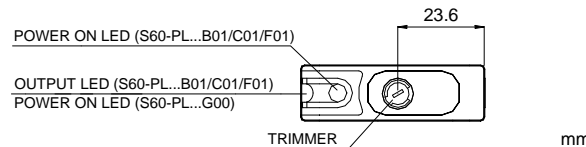
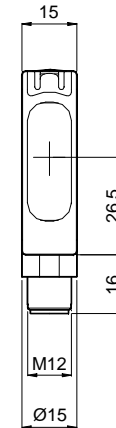

#### CABLE VERSION

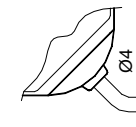

### TECHNICAL DATA

Power supply:	10 ... 30 Vdc limit values
Ripple:	2 Vpp max.
Consumption (output current excluded):	35 mA max.
Outputs:	N.O. and N.C.; PNP or NPN; 30 Vdc max. (short-circuit protection) (mod. B01/C01/F01)
Output current:	100 mA max.
Output saturation voltage:	≤ 2 V
Response time:	250 µs (mod. B01/C01); 333 µs (F01)
Switching frequency:	2 kHz (mod. B01/C01); 1.5 kHz (F01)
Indicators:	OUTPUT LED (YELLOW) (mod. B01/C01/F01) POWER ON LED (GREEN) (mod. B01/C01/F01/G00)
Setting:	sensitivity trimmer (mod. B01/C01/F01)
Operating mode:	LIGHT mode on N.O. output / DARK mode on N.C. output (mod.C01) DARK mode on N.O. output / LIGHT mode on N.C. output (mod.B01/F01)
Operating temperature:	-10 ... 50 °C
Storage temperature:	-25 ... 70 °C
Electrical protection:	Class 2
Operating distance (typical values):	B01: 0.1...20 m on R2 C01: 0...50 cm F01/G00: 0...60 m
Emission type:	RED LASER: Class 1 EN 60825-1 (1994) (mod.B01/C01/G00) Class II CDRH 21 CFR PART 1040.10 (mod.B01/C01/G00) Max. power ≤ 1 mW; Pulse = 4.2 µs (mod.B01/C01); 5 µs (mod.G00); λ = 630...680 nm; Frequency = 33.5 kHz (mod.B01/C01); 10 kHz (mod.G00)
Ambient light rejection:	according to EN 60947-5-2
Vibrations:	0.5 mm amplitude, 10 ... 55 Hz frequency, for every axis (EN60068-2-6)
Shock resistance:	11 ms (30 G) 6 shock for every axis (EN60068-2-27)
Housing material:	ABS
Lens material:	window in PMMA, lenses in glass and polycarbonate
Mechanical protection:	IP67
Connections:	2 m Ø 4 mm cable / M12 4-pole connector
Weight:	90 g, max. cable vers. / 40 g, max. connector vers.

### SETTING

#### Setting of S60-PL...B01

Position the sensor and reflector aligned on opposite sides.

Turn the sensitivity trimmer to the maximum position.

Moving the sensor both vertically and horizontally, determine the power on and off points of the yellow LED (OUT) and then mount the sensor in the middle of the points defined.

Reduce sensitivity if very small objects have to be detected. Repeat procedure reducing progressively the sensitivity in order to improve alignment.

#### Setting of S60-PL...F01/G00

Position the sensors aligned on opposite sides.

Turn the sensitivity trimmer to maximum: moving the sensor both vertically and horizontally, determine the power on and off points of the yellow LED (OUT) and then mount the sensor in the middle of the points defined so that the yellow LED remains off.

If necessary, reduce sensitivity using the trimmer, in order to detect very small targets. In order to improve alignment, repeat the procedure detailed above whilst progressively reducing the sensitivity.

#### Setting of S60-PL...C01

Adjust the sensitivity trimmer to minimum: the yellow LED is off.

Position the target to detect in front of the sensor.

Turn the sensitivity trimmer clockwise until the yellow LED turns ON (Target detected state, pos.A).

Remove the target, the yellow LED turns OFF.

Turn the sensitivity trimmer clockwise until the yellow LED turns ON (Background detected state, pos.B).

The trimmer reaches maximum if the background is not detected.

Turn the trimmer to the intermediate position C, between the two positions A and B.



### TEST FUNCTION (S60-PL...G00)

The TEST+ input can be used to inhibit the emitter and verify that the system is correctly operating.

The receiver output should switch when the test is activated while the beam is uninterrupted.

The inputs activating voltage range is 10 ... 30 Vdc, with respect to 0V input (blue wire pin3).

Connect the TEST+ input to 0V if not used.

#### DECLARATION OF CONFORMITY

We DATALOGIC AUTOMATION declare under our sole responsibility that these products are conform to the 2004/108/CE and successive amendments.



#### WARRANTY

DATALOGIC AUTOMATION warrants its products to be free from defects.

DATALOGIC AUTOMATION will repair or replace, free of charge, any product found to be defective during the warranty period of 36 months from the manufacturing date.

This warranty does not cover damage or liability deriving from the improper application of DATALOGIC AUTOMATION products.

#### DATALOGIC AUTOMATION

Via Lavino 265 - 40050 Monte S.Pietro - Bologna - Italy

Tel: +39 051 6765611 - Fax: +39 051 6759324

www.automation.datalogic.com e-mail: info.automation@datalogic.com

DATALOGIC AUTOMATION cares for the environment: 100% recycled paper. DATALOGIC AUTOMATION reserves the right to make modifications and improvements without prior notification.

Datalogic and the Datalogic logo are registered trademarks of Datalogic S.p.A. in many countries, including the U.S.A. and the E.U.

826001582 Rev.D

© Copyright Datalogic 2007-2009