

 **DATALOGIC**

# BC9xx0-STAR

## Base Station/Charger



**Quick Reference Guide**

## **Datalogic ADC, Inc.**

959 Terry Street  
Eugene, OR 97402  
USA

Telephone: (541) 683-5700

Fax: (541) 345-7140

## **©2013-2014 Datalogic, Inc.**

An Unpublished Work - All rights reserved. No part of the contents of this documentation or the procedures described therein may be reproduced or transmitted in any form or by any means without prior written permission of Datalogic ADC, Inc. or its subsidiaries or affiliates ("Datalogic" or 'Datalogic ADC'). Owners of Datalogic products are hereby granted a non-exclusive, revocable license to reproduce and transmit this documentation for the purchaser's own internal business purposes. Purchaser shall not remove or alter any proprietary notices, including copyright notices, contained in this documentation and shall ensure that all notices appear on any reproductions of the documentation.

Should future revisions of this manual be published, you can acquire printed versions by contacting your Datalogic representative. Electronic versions may either be downloadable from the Datalogic website ([www.datalogic.com](http://www.datalogic.com)) or provided on appropriate media. If you visit our website and would like to make comments or suggestions about this or other Datalogic publications, please let us know via the "Contact Datalogic" page.

### **Disclaimer**

Datalogic has taken reasonable measures to provide information in this manual that is complete and accurate, however, Datalogic reserves the right to change any specification at any time without prior notice.

Datalogic and the Datalogic logo are registered trademarks of Datalogic S.p.A. in many countries, including the U.S.A. and the E.U. All other brand and product names may be trademarks of their respective owners.

### **Patents**

See [www.patents.datalogic.com](http://www.patents.datalogic.com) for patent list.

This product is covered by one or more of the following patents:

Utility patents: US7948214, EP1873886B1, ZL200780030808.2



# Table of Contents

END USER LICENSE AGREEMENT .....	iii
Software Product Policy .....	v
Customers Under Software Support .....	v
Using the BC9xx0 Base Station .....	1
Installation .....	2
Mounting the BC9xx0 Cradle .....	2
Mounting Brackets .....	2
To change the Bracket:.....	3
Permanent Mounting .....	4
Mounting for Portable Use .....	4
Mounting the Metal Plate.....	4
Attaching the Metal Plate to Base.....	5
System Connections .....	6
BC9x80 models - Ethernet Connection .....	6
Ferrite Clamp Filter.....	6
Non-Ethernet Connection .....	7
Connecting and Disconnecting the Multi-Interface Cable .....	7
Configuration .....	8
BC9x80 Ethernet Models .....	8
Non-Ethernet Models .....	8
Datalogic Aladdin™.....	8
Serial Configuration.....	8
Configuration Bar Codes .....	9
Selecting the Interface Type .....	9
Configuring the Interface .....	9
Ethernet Interface (BC9x80 Models only).....	9
RS-232 .....	10
USB.....	11
Keyboard Interface .....	12
Scancode Tables.....	13
Country Mode .....	14
Caps Lock State .....	18
Numlock .....	19
Resetting Standard Product Defaults .....	20
Compatibility with the PowerScan™ 8000 family .....	20
Technical Features .....	21
Regulatory Information .....	23
Compliance .....	23
Power Supply .....	23
FCC Compliance .....	23

---

Radio Compliance.....	23
China RoHS Statement.....	24
WEEE Compliance .....	25
Datalogic ADC Limited Factory Warranty .....	26
Ergonomic Recommendations .....	27
Services and Support .....	28
Products.....	28
Service & Support.....	28
Contact Us.....	28

# Datalogic ADC, Inc.

## PowerScan™ 9500 PRODUCT SERIES

### END USER LICENSE AGREEMENT

**Notice to End User:** The Datalogic Product you have acquired contains embedded Software, which is integral to the product's operation. This Software is being provided to you under license, subject to the terms and conditions of this Agreement. If you use the Datalogic Product, you will be deemed to have accepted the terms and conditions of this Agreement. If you do not intend to be bound to the terms of this Agreement, Datalogic is not willing to license the Software to you, you may not use the Datalogic Product or the Software, and you must contact the party from whom you acquired the Datalogic Product for instructions.

#### END USER LICENSE AGREEMENT TERMS:

This End User Software License Agreement ("Agreement") is a legally binding agreement governing the licensing of the Software and Documentation by Datalogic ADC, Inc. and its Affiliates ("Datalogic") to the entity or person who has purchased or otherwise acquired a Datalogic Product ("End User"). For purposes of this Agreement, any software that is associated with a separate end-user license agreement is licensed to you under the terms of that license agreement. Datalogic and End User hereby agree as follows:

#### 1. Definitions

- 1.1 "Affiliate" means a business entity currently existing or later acquired that controls, is controlled by, or is under common control with Datalogic S.p.A.
- 1.2 "Documentation" means materials such as user's guides, program reference guides, quick reference guides, manuals, or similar materials associated with or related to the Datalogic Product, whether in printed, "online", or other form.
- 1.3 "Proprietary Information" means: (a) source code, object code, software, documentation, and any related internal design, system design, data base design, algorithms, technology, technical data or information, implementation techniques, and trade secrets related to the Software, (b) any other trade secrets marked appropriately or identified as proprietary or confidential, and (c) any information that End User, under the circumstances, should recognize as confidential. Proprietary Information does not include any information that the receiving party can establish was (1) in the public domain, (2) already in the receiving party's possession or rightfully known prior to receipt, (3) rightfully learned from a third party not in violation of any other's proprietary rights, or (4) independently developed without access to Proprietary Information.
- 1.4 "Datalogic Product" means the Datalogic® Powerscan™ series scanner product, including all embedded Software in and all Documentation related to such product, which has been purchased or otherwise acquired by End User, whether obtained directly or indirectly from Datalogic.
- 1.5 "Software" means any software or computer programs of Datalogic or its third party licensors in machine readable form which is embedded in the Datalogic Product, whether obtained directly or indirectly from Datalogic, including any replacement, update, upgrade, enhancement or modification.

#### 2. Scope Of License Granted

- 2.1 Datalogic grants to End User a non-exclusive, non-transferable, perpetual license to use the Software, solely on the Datalogic Product in which it is embedded ("designated Datalogic Product"), in machine-readable form only, solely for End User's internal business purposes. This Agreement does not convey ownership of the Software to End User. Title to the Software shall be and remain with Datalogic or the third party from whom Datalogic has obtained a licensed right. As used in this Agreement, the term "purchase" or its equivalents when applied to the Software shall mean "acquire under license." End User is not entitled to receipt or use of the source code to any Software.
- 2.2 End User shall not copy, modify, decompile, disassemble, reverse engineer, or otherwise reproduce or remanufacture the Software, whether modified or unmodified, nor sell, assign, sublicense, distribute, lend, rent, give, or otherwise transfer the Software to any other person or organization, for purposes other than as expressly provided in this Agreement, without Datalogic's prior written consent.

#### 3. Transfers, Support

- 3.1 Any copying, installing, reproduction, remanufacture, reverse engineering, electronic transfer, or other use of the Software on other than the designated Datalogic Product will be a material breach of this Agreement. However, Datalogic may elect not to terminate this Agreement or the granted licenses, but instead may elect to notify End User that End User is deemed to have ordered and accepted a license for each breaching use. End User shall pay Datalogic the applicable list price for such licenses as of the date of such breach.
- 3.2 End User shall not sell, assign, sublicense, distribute, lend, rent, give, or otherwise transfer the Datalogic Product to any third party unless such third party agrees with Datalogic in writing to be bound by the terms and conditions of this Agreement. Any such transfer of the Datalogic Product absent such agreement shall be null and void.
- 3.3 End User may obtain support for Software from Datalogic at Datalogic's standard support fees and under Datalogic's standard support terms and conditions in effect at the time the support is requested.

#### 4. Intellectual Property

End User acknowledges that the Software constitutes valuable trade secrets of Datalogic or Datalogic's third party licensors and that the Software is protected by intellectual property laws and treaties. The license set forth in this Agreement does not transfer to End User any ownership of Datalogic's or its third party licensors' copyrights, patents, trademarks, service marks, trade secrets, or other intellectual property rights and End User shall have no right to commence any legal actions to obtain such rights. End User shall not remove, modify, or take any other action that would obscure any copyright, trademark, patent marking, or other intellectual property notices contained in or on the Datalogic Product.

## 5. Proprietary Information

- 5.1 End User acknowledges that Proprietary Information is the confidential, proprietary, and trade secret property of Datalogic and Datalogic's third party licensors and End User acquires no right or interest in any Proprietary Information.
- 5.2 End User shall not disclose, provide, or otherwise make available the Proprietary Information of Datalogic or its third party licensors to any person other than End User's authorized employees or agents who are under confidentiality agreement, and End User shall not use the Proprietary Information other than in conjunction with use of the Datalogic Product exclusively for End User's internal business purposes. End User shall take steps to protect the Proprietary Information no less securely than if it were End User's own intellectual property.
- 5.3 The provisions of this Proprietary Information Section shall survive and continue for five (5) years after the termination of this Agreement.

## 6. Limited Warranty

- 6.1 Datalogic warrants that, under normal use and operation, the Datalogic Product will conform substantially to the applicable Documentation for the period specified in the Documentation. During this period, for all reproducible nonconformities for which Datalogic has been given written notice, Datalogic will use commercially reasonable efforts to remedy nonconformities verified by Datalogic. End User agrees to supply Datalogic with all reasonably requested information and assistance necessary to help Datalogic in remedying such nonconformities. For all defects reported to Datalogic within the warranty period, Datalogic's liability is limited to providing End User with one copy of corrections or responding to End User's problem reports according to Datalogic's standard assistance practices. Datalogic does not warrant that the product will meet End User's requirements or that use of the product will be uninterrupted or error free, or that Datalogic's remedial efforts will correct any nonconformance. This limited warranty does not cover any product that have been subjected to damage or abuse, whether intentionally, accidentally, or by neglect, or to unauthorized repair or unauthorized installation, and shall be void if End User modifies the product, uses the product in any manner other than as established in the Documentation, or if End User breaches any of the provisions of this Agreement.
- 6.2 EXCEPT AS PROVIDED IN THIS AGREEMENT, THE DATALOGIC PRODUCT IS PROVIDED "AS IS" AND DATALOGIC MAKES NO WARRANTIES OF ANY KIND, EXPRESS OR IMPLIED, WRITTEN OR ORAL, WITH RESPECT TO THE PRODUCT, AND SPECIFICALLY DISCLAIMS THE IMPLIED WARRANTIES OF MERCHANTABILITY AND FITNESS FOR A PARTICULAR PURPOSE.

## 7. Infringement

- 7.1 Datalogic will defend End User against any claim in a lawsuit that the Datalogic Product furnished hereunder infringe a United States patent or copyright of a third party and Datalogic will pay any damages finally awarded against End User by a court of competent jurisdiction that are attributable to such claim or will pay End User's part of any settlement that is attributable to such claim, provided, that 1) End User notifies Datalogic promptly in writing of the claim, 2) Datalogic controls the defense or settlement of the claim, and 3) End User cooperates fully with Datalogic in such defense or settlement. All notices of a claim should be sent to Datalogic ADC, Inc., Legal Department, 959 Terry Street, Eugene, OR 97402.
- 7.2 In the defense or settlement of any such claim, Datalogic may, at its option, 1) procure for End User the right to continue using the Datalogic Product, 2) modify the Datalogic Product so that it becomes non-infringing, 3) replace the Datalogic Product with an equivalent product not subject to such claim, or 4) provide End User an opportunity to return the Datalogic Product and receive a refund of the purchase price paid, less a reasonable allowance for use.
- 7.3 Datalogic shall have no liability to End User for claims of infringement based upon 1) the use of any Datalogic Product in combination with any product which Datalogic has not either furnished or authorized for use with such Datalogic Product 2) the use of any Datalogic Product designed, manufactured, or modified to the specifications of End User, or 3) End User's modification of the Datalogic Product without written authorization from Datalogic.
- 7.4 THE FOREGOING STATES DATALOGIC'S COMPLETE AND ENTIRE OBLIGATION CONCERNING CLAIMS OF PATENT, COPYRIGHT, OR OTHER INTELLECTUAL PROPERTY INFRINGEMENT, CANCELS AND SUPERCEDES ANY PRIOR AGREEMENTS, WHETHER ORAL OR WRITTEN, BETWEEN THE PARTIES CONCERNING SUCH CLAIMS, AND WILL NOT BE MODIFIED OR AMENDED BY ANY PAST, CONTEMPORANEOUS, OR FUTURE AGREEMENTS OR DEALINGS BETWEEN THE PARTIES, WHETHER ORAL OR WRITTEN, EXCEPT AS SET FORTH IN A FUTURE WRITING SIGNED BY BOTH PARTIES.

## 8. Limitation Of Liability

EXCEPT AS PROVIDED IN SECTION 7, DATALOGIC SHALL NOT BE LIABLE FOR ANY CLAIMS AGAINST END USER BY ANY OTHER PARTY. IN NO EVENT SHALL DATALOGIC'S LIABILITY FOR DAMAGES, IF ANY, WHETHER BASED UPON CONTRACT, TORT (INCLUDING NEGLIGENCE), PRODUCT LIABILITY, STRICT LIABILITY, WARRANTY, OR ANY OTHER BASIS, EXCEED THE PRICE OR FEE PAID BY END USER FOR THE DATALOGIC PRODUCT. UNDER NO CIRCUMSTANCES SHALL DATALOGIC BE LIABLE TO END USER OR ANY THIRD PARTY FOR LOST PROFITS, LOST DATA, INTERRUPTION OF BUSINESS OR SERVICE, OR FOR ANY OTHER SPECIAL, CONSEQUENTIAL, CONTINGENT, INDIRECT, INCIDENTAL, PUNITIVE, EXEMPLARY, OR OTHER SIMILAR DAMAGES, EVEN IF DATALOGIC HAS BEEN ADVISED OF THE POSSIBILITY OF SUCH DAMAGES.

## 9. Government Restricted Rights; International Use

- 9.1 Use, duplication, or disclosure of the Software by the U.S. Government is subject to the restrictions for computer software developed at private expense as set forth in the U.S. Federal Acquisition Regulations at FAR 52.227-14(g), or 52.227-19 or in the Rights in Technical Data and Computer Software clause at DFARS 252.227-7013(c)(1)(ii), whichever is applicable.
- 9.2 If End User is using the Datalogic Product outside of the United States, End User must comply with the applicable local laws of the country in which the Datalogic Product is used, with U.S. export control laws,

and with the English language version of this Agreement. The provisions of the "United Nations Convention on International Sale of Goods" shall not apply to this Agreement.

### 10. Termination

- 10.1 Either party may terminate this Agreement or any license granted under this Agreement at any time upon written notice if the other party breaches any provision of this Agreement.
- 10.2 Upon termination of this Agreement, End User immediately shall cease using any nonembedded software and shall return to Datalogic or destroy all non-embedded software covered by this Agreement, and shall furnish Datalogic with a certificate of compliance with this provision signed by an officer or authorized representative of End User. For embedded software, End User agrees to sign a waiver prepared by Datalogic concerning further use of the embedded Software. End User's resumed or continued use of the embedded Software after termination shall constitute End User's agreement to be bound by the terms and conditions of this Agreement for such use.

### 11. General Provisions

- 11.1 Entire Agreement; Amendment. This document contains the entire agreement between the parties relating to the licensing of the Software and supersedes all prior or contemporaneous agreements, written or oral, between the parties concerning the licensing of the Software. This Agreement may not be changed, amended, or modified except by written document signed by Datalogic.
- 11.2 Notice. All notices required or authorized under this Agreement shall be given in writing, and shall be effective when received, with evidence of receipt. Notices to Datalogic shall be sent to the attention of Contract Administration, Datalogic ADC, Inc., 959 Terry Street, Eugene, OR 97402, or such other address as may be specified by Datalogic in writing.
- 11.3 Waiver. A party's failure to enforce any of the terms and conditions of this Agreement shall not prevent the party's later enforcement of such terms and conditions.
- 11.4 Governing Law; Venue: This Agreement and the rights of the parties hereunder shall be governed by and construed in accordance with the laws of the State of Oregon U.S.A, without regard to the rules governing conflicts of law. The state or federal courts of the State of Oregon located in either Multnomah or Lane counties shall have exclusive jurisdiction over all matters regarding this Agreement, except that Datalogic shall have the right, at its absolute discretion, to initiate proceedings in the courts of any other state, country, or territory in which End User resides, or in which any of End User's assets are located.
- 11.5 Attorneys' Fees. In the event an action is brought to enforce the terms and conditions of this Agreement, the prevailing party shall be entitled to reasonable attorneys' fees, both at trial and on appeal.

- END -

## Software Product Policy

Datalogic reserves the right to ship its products with the latest version of software/firmware available. This provides our customers with the very latest in Datalogic software technology.

The only exception to this policy is when the buyer has a signed contract with Datalogic that clearly defines the terms and conditions for making software/firmware changes in products shipped to the buyer.

### Customers Under Software Support

Customers that elect to subscribe to Datalogic Software Maintenance and Support Agreement will receive 30 days advance notification of: (1) the release of a new software version; and/or (2) discontinuation of any prior software version that will no longer be supported. Datalogic will provide maintenance for a fee that will assist customers in transitioning to the next software version. If a customer is currently using the software version being discontinued, the customer may elect to transition to any one of the newer versions, depending on the hardware in use.

To arrange for a Software Maintenance and Support Agreement please contact your Datalogic sales person.

# NOTES





## Using the BC9xx0 Base Station

The BC9xx0 base station, when paired with one or more PowerScan™ PM9500 readers, builds a Cordless Reading System for the collection, decoding and transmission of bar code data. It can be connected to a Host PC via RS-232, USB, or KBD Wedge, and is suited for single-cradle layouts.

The BC9x60 models also allow multi cradle layouts through an RS-485 Network. For this network connection refer to the Programming Reference Guide. The BC91x0 models provide a spare battery charger slot. The BC9x80 models are provided with an Ethernet interface.

The label on the cradle contains LED indicators and a multi-function button. When the button is pressed for less than 5 seconds, the cradle will transmit a "broadcast" message. When the broadcast is sent, all properly configured scanners (Radio RX Timeout set to keep the radio "awake") that are linked to that base and within radio range coverage will emit a beep and blink within 5 seconds. This functionality is useful to:

- verify which scanners are linked to a certain base station
- detect a scanner forgotten somewhere

The LEDs signal the BC9xx0 status, as shown.

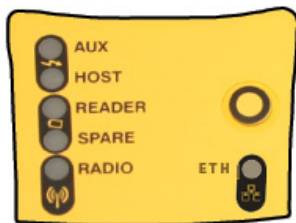

LED	STATUS
Aux	Yellow On = BC9xx0 is powered through an external power supply.
Host	Yellow On = BC9xx0 is powered by the Host.
Reader	Green On = the reader battery is completely charged. Red On = the reader battery is charging. Orange Blinking = reader battery fault - replace battery. Red / Green Alternatively Blinking = charging error - see PRG. Off = reader not in the cradle or not properly inserted.
Spare (BC91x0 models only)	Green On = the spare battery is completely charged. Orange Blinking = spare battery fault - replace spare battery. Red / Green Alternatively Blinking = charging error - see PRG. Off = no spare battery in the housing or battery not fully inserted.
Radio	Yellow Blinking = radio activity.
Ethernet (Ethernet models only)	Green Blinking = Ethernet activity.

# Installation

To set up your BC9xx0 cradle you must:

1. Physically install the cradle.
2. Make all system connections.
3. Configure the BC9xx0 cradle.

## Mounting the BC9xx0 Cradle

The cradle package contains the following items:

- BC9xx0 Base Station (with Desktop Mounting Bracket installed)
- BC9xx0 Quick Reference Guide (this manual)
- 1 Ferrite Clamp (Ethernet models only)
- 1 Metal Mounting plate
- 1 Wall Mounting Bracket

The cradle can be either mounted on a flat surface for desktop usage or affixed vertically to a wall.

## Mounting Brackets

The cradle comes with two different mounting brackets. The appropriate bracket is used depending on whether the cradle will be mounted on a horizontal or vertical surface. When shipped, the cradle has the Desktop Mounting Bracket installed. For vertical installation, the Wall Mounting Bracket must be attached instead.

Figure 1. Mounting Brackets

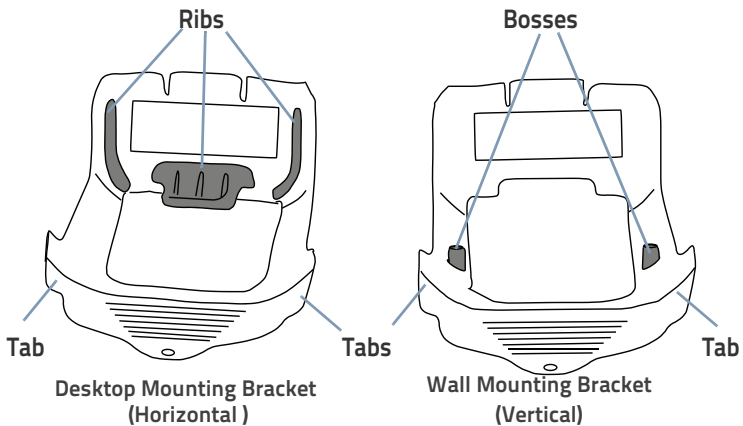

- Desktop mount bracket has ribs to keep the scanner in place when the cradle is horizontal
- Wall mount bracket contains bosses to keep the scanner in place when the cradle is vertical.

### To change the Bracket:

1. Remove the screw holding the Bracket in place. Retain the screw for re-use.
2. Carefully lift off the Bracket.
3. Install the other bracket by first slipping the end tab into place on the base station, then easing the tabs (shown in [Figure 1 on page 2](#)) into place on the sides.
4. Replace the screw to secure the Bracket to the Base Station.

**Figure 2. Changing the Bracket**



## Permanent Mounting

For either desktop or wall mounting, the cradle can be fastened directly to a flat surface using screws (not included).



**When mounting on drywall, the base should be screwed to a wall stud or supporting beam for additional support.**

Figure 3. Base Station Bottom

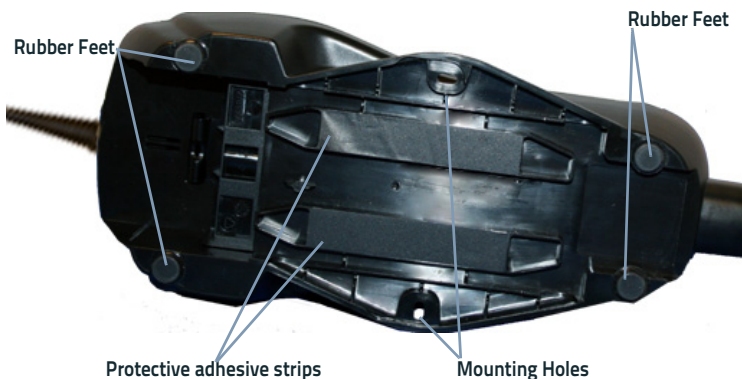

## Mounting for Portable Use

If portability of the cradle is required, the metal plate must be used. There are two ways this can be done: (1) by first mounting the metal plate on a flat surface so the cradle can be slid off and on, or (2) mounting the metal plate onto the back of the base station and then screwing both to the desired surface.



**For additional security on wall mounting, it is strongly recommended that the cradle be secured into place using two auxiliary screws through the mounting holes on the side.**

## Mounting the Metal Plate

1. Affix the metal plate onto the desired mounting surface using the two center screw holes (see [Figure 4](#) on [page 5](#)).
2. Remove the adhesive strips protecting the mounting tabs on the cradle, shown in [Figure 3](#).
3. Slide the tabs on the back of the cradle onto the metal plate as shown in [Figure 4](#).
4. After aligning the tabs, push up to lock into place.

Figure 4. Mounting Plate on Wall



### Attaching the Metal Plate to Base

Alternatively, the mount can be attached first to the base, then both can be mounted to a wall as described above.

Figure 5. Attaching Mounting Plate to Base

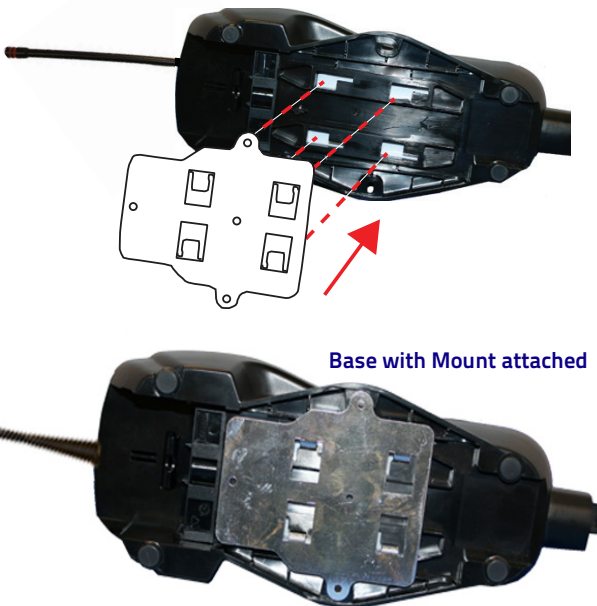

# System Connections



Connections should always be made with power off!

## BC9x80 models - Ethernet Connection

The BC9x80 models contain an Ethernet connector and a power supply connector. A multi-interface connector is also available (intended for service purposes only).

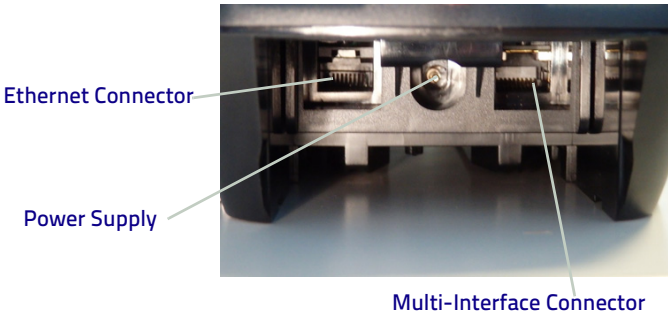

Ensure the cable is plugged into the correct connector. Forcing an Ethernet cable into the Multi-interface connector or forcing a Multi-interface cable into the Ethernet connector could damage the unit.

## Ferrite Clamp Filter



If a Ferrite Clamp filter is included in the package, mount it on the Ethernet cable as shown, about 5 cm from the plug.

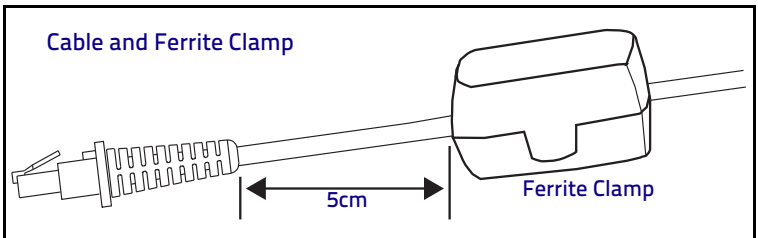

## Non-Ethernet Connection

The BC9xx0 cradle provides a multi-interface connector and a power supply connector as shown:

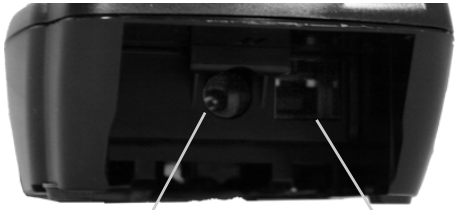

Power Supply

Multi-Interface Connector

## Connecting and Disconnecting the Multi-Interface Cable

The BC9xx0 can be connected to a Host by means of a multi-interface cable, which must be simply plugged into the Host connector, visible on the front panel of the cradle.

To disconnect the cable, insert a paper clip or other similar object into the hole corresponding to the Host connector on the body of the cradle. Push down on the clip while unplugging the cable. Refer to the following figures:

### Connecting/Disconnecting the Cable

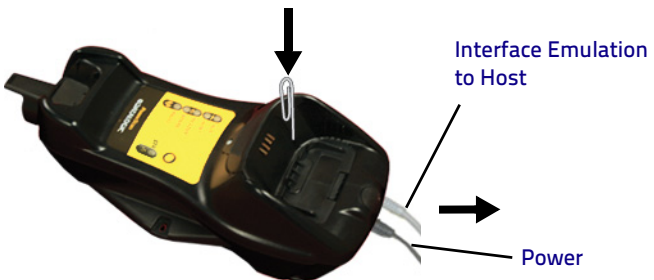

### RS-232



### USB



### WEDGE

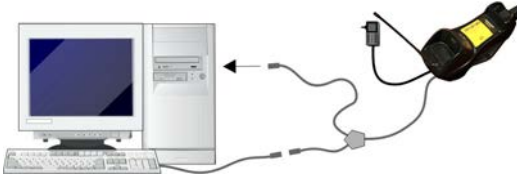

## Configuration

### BC9x80 Ethernet Models

BC9x80 configuration can be performed using the Datalogic Aladdin software configuration program or by reading configuration bar codes with the PowerScan PM9500 reader.

### Non-Ethernet Models

The BC9xx0 configuration can be performed in three ways: by using the Datalogic Aladdin™ software configuration program, by sending configuration strings from the Host PC via the RS-232 or USB-COM interface or by reading configuration bar codes with the PowerScan™ PM9500 reader.

### Datalogic Aladdin™

Datalogic Aladdin™ (available for free download from the Datalogic website) is a multi-platform utility program that provides a quick and user-friendly configuration method via the RS-232/USB-COM or Ethernet interface. It also allows upgrading the software of the connected device (see the Datalogic Aladdin™ Help On-Line for more details).

### Serial Configuration

By connecting the BC9xx0 to a PC through an RS-232 or USB-COM interface cable it is possible to send configuration strings from the PC to BC9xx0.



## Configuration Bar Codes

Link the cradle and the reader using the procedures described in the PowerScan™ PM9500 Quick Reference. Once the pairing is complete, you can configure the BC9xx0 cradle by reading the configuration bar codes in this manual. To configure the BC9xx0 using the PowerScan™ PM9500 reader (paired to the cradle with the Bind command), follow the procedure according to the interface selected.

## Selecting the Interface Type

Upon completing the physical connection between the reader and its host, scan the appropriate bar code for your system's correct interface type.

## Configuring the Interface

Scan the programming bar code which selects the appropriate interface type for the system the reader will be connected to.







Unlike some other programming features and options, interface selections require that you scan only one programming bar code label. **DO NOT** scan an ENTER/EXIT bar code prior to scanning an interface selection bar code.

Some interfaces require the scanner to start in the disabled state when powered up. If additional scanner configuration is desired while in this state, pull the trigger and hold for 5 seconds. The scanner will change to a state that allows programming with bar codes.

### Ethernet Interface (BC9x80 Models only)



Use the programming bar codes below to program the Ethernet interface, to select between standard and Ethernet/IP and to choose between fixed IP address and DHCP.





ETHERNET
 Select Standard Ethernet
 Select Ethernet/IP

ETHERNET (continued)
 Select Static IP Addressing <sup>a</sup>
 Select Dynamic IP Addressing <sup>b</sup>

- a. When Static IP Addressing is selected, 192.168.187.31 will be used as a default; this can be changed using the Datalogic Aladdin configuration program.
- b. To use Dynamic IP Addressing , you must be sure that your network system supports a DHCP server.

## Serial Interface



RS-232
RS-232 standard interface  Select RS232-STD
RS-232 Wincor-Nixdorf  Select RS232-WN
RS-232 for use with OPOS/UPOS/JavaPOS  Select RS-232 OPOS

USB
USB COM to simulate RS-232 standard interface  USB-COM-STD <sup>a</sup>
USB-OEM (can be used for OPOS/UPOS/JavaPOS)  USB-OEM
USB Keyboard with standard key encoding  Select USB Keyboard
USB Keyboard with alternate key encoding  USB Alternate Keyboard
USB Keyboard for Apple computers  USB-KBD-APPLE

a. Download the correct USB COM driver from [www.datalogic.com](http://www.datalogic.com)

## Keyboard Interface

Use the programming bar codes to select options for USB Keyboard and Wedge Interfaces.

KEYBOARD
AT, PS/2 25-286, 30-286, 50, 50Z, 60, 70, 80, 90 & 95 w/ Standard Key Encoding  Select KBD-AT
Keyboard Wedge for IBM AT PS2 with standard key encoding but without external keyboard  Select KBD-AT-NK
AT, PS/2 25-286, 30-286, 50, 50Z, 60, 70, 80, 90 & 95 w/Alternate Key  Select KBD-AT-ALT
Keyboard Wedge for IBM AT PS2 with alternate key encoding but without external keyboard  Select KBD-AT-ALT-NK
PC/XT w/Standard Key Encoding  Select KBD-XT

KEYBOARD (continued)
Keyboard Wedge for IBM Terminal 3153  Select KBD-IBM-3153
Keyboard Wedge for IBM Terminals 31xx, 32xx, 34xx, 37xx make only keyboard  Select KBD-IBM-M
Keyboard Wedge for IBM Terminals 31xx, 32xx, 34xx, 37xx make break keyboard  Select KBD-IBM-MB
Keyboard Wedge for DIGITAL Terminals VT2xx, VT3xx, VT4xx  Select KBD-DIG-VT

## Scancode Tables

Reference the PowerScan™ 9500 PRG for information about control character emulation which applies to keyboard interfaces.

## Country Mode







This feature specifies the country/language supported by the keyboard. Only these interfaces support ALL Country Modes:

- USB Keyboard (without alternate key encoding)
- AT, PS/2 25-286, 30-286, 50, 50Z, 60, 70, 80, 90 & 95 w/Std Key Encoding
- Keyboard Wedge for IBM AT PS2 with standard key encoding but without external keyboard
- AT, PS/2 25-286, 30-286, 50, 50Z, 60, 70, 80, 90 & 95 without Alternate Key
- Keyboard Wedge for IBM AT PS2 without alternate key encoding but without external keyboard

All other interfaces support ONLY the following Country Modes: U.S., Belgium, Britain, France, Germany, Italy, Spain, Sweden.

COUNTRY MODE
 ENTER/EXIT PROGRAMMING MODE
 Country Mode = U.S.
 Country Mode = Belgium
 Country Mode = Britain

\*Supports only the interfaces listed in the Country Mode feature description

COUNTRY MODE (continued)
 Country Mode = Croatia*
 Country Mode = Czech Republic*
 Country Mode = Denmark*
 Country Mode = France
 Country Mode = French Canadian
 Country Mode = Germany

\*Supports only the interfaces listed in the Country Mode feature description

COUNTRY MODE (continued)
 Country Mode = Hungary*
 Country Mode = Italy
 Country Mode = Japanese 106-key*
 Country Mode = Lithuanian
 Country Mode = Norway*
 Country Mode = Poland*
 Country Mode = Portugal*

\*Supports only the interfaces listed in the Country Mode feature description



COUNTRY MODE (continued)
 Country Mode = Romania*
 Country Mode = Spain
 Country Mode = Sweden
 Country Mode = Slovakia*
 Country Mode = Switzerland*

\*Supports only the interfaces listed in the Country Mode feature description

## Caps Lock State

This option specifies the format in which the reader sends character data. This applies to keyboard wedge interfaces. This does not apply when an alternate key encoding keyboard is selected.

CAPS LOCK STATE
 ENTER/EXIT PROGRAMMING MODE
 Caps Lock State = Caps Lock OFF
 Caps Lock State = Caps Lock ON
 Caps Lock State = AUTO Caps Lock Enable

## Numlock

This option specifies the setting of the Numbers Lock (Numlock) key while in keyboard wedge interface. This only applies to alternate key encoding interfaces. It does not apply to USB keyboard.

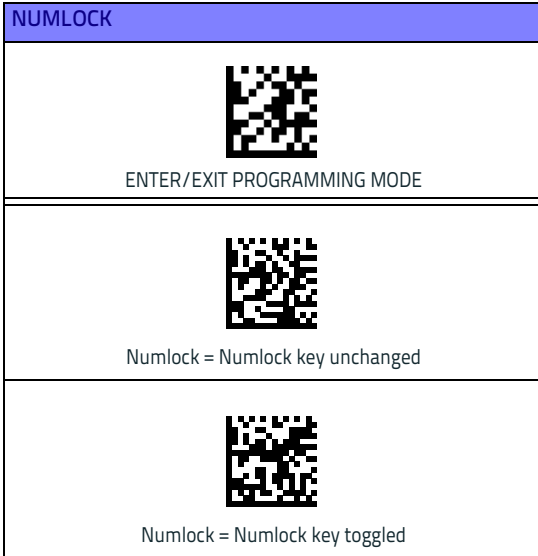

## Resetting Standard Product Defaults

Reference the PRG for a listing of standard factory settings. If you aren't sure what programming options are in your reader, or you've changed some options and want the factory settings restored, scan the **Standard Product Default Settings** bar code below to copy the factory configuration for the currently active interface to the current configuration.



Factory defaults are based on the interface type. Configure the reader for the correct interface before scanning this label.



Standard Product Default Settings



Scanning this bar code will **RESET** all settings for the PowerScan PM9500. Any customized settings that may have been applied to the reader will be lost.

To change the defaults refer to the PowerScan™ 9500 PRG, or to the Datalogic Aladdin™ Configuration program, both downloadable from the Datalogic website.

## Compatibility with the PowerScan™ 8000 family

The BC9xx0 can be programmed to operate in a mode compatible with the PowerScan 8000 family. For further details and for the relevant configuration strings and labels, refer to the PRG.

## Technical Features

<b>Electrical Features</b>		
Supply Voltage	External Power Host Power <sup>a</sup>	10 - 30 VDC 5 VDC ±10%
Power Consumption	External Power Host Power <sup>a</sup>	max. 10 W (charging) <sup>b</sup> max. 500 mA (charging)
Indicators		Ext. Power/Data yellow LED Host Power/Data yellow LED Reader batt. state green/red LED Spare batt. state green/red LED Radio yellow LED Ethernet green LED (Ethernet models only)
Time of Recharge	External Power Host Power <sup>a</sup>	max. 4 hours with 2150 mAh Li-Ion battery max. 10 hours with 2150 mAh Li-Ion battery

- a. Host Power not supported on Ethernet Models
- b. Having a switching regulator inside, the BC9xx0 draws the same power, regardless of the supply voltage; i.e., as the input voltage increases the current drawn decreases

<b>Environmental Features</b>		
Working Temperature	Radio Battery Charging	-20° to +50 °C / -4 to +122 °F 0° to +40 °C / +32° to +104 °F
Storage Temperature		-20° to +70 °C / -4 to +158 °F
Humidity		90% non condensing
Protection Class		IP40
<b>Mechanical Features</b>		
Weight without metal plate		about 390 g / 13.76 oz
Dimensions (without antenna)		235 x 108 x 80 mm
<b>Regulatory</b>		
Electrical Safety	UL 60950, CSA C22.2 No. 60950, IEC 60950	
EMI/RFI	<b>433 MHz model</b> Europe - CE, Russia – Gost; Australia – Ctick; China – SRRC; Singapore – IDA, Anatel Brazil	<b>910 MHz model</b> USA/Canada – FCC/IC; Mexico – NOM + Cofetel

<b>Regulatory (continued)</b>		
Laser Class Safety	IEC Class 2 Radiation 1 mW Avg., Emitted wavelength 650 nm, 12ms pulse, Beam Divergence 8.4 deg x 8.1 deg (‘plus’ pattern)	
Complies with FDA performance standards for laser products except for deviations pursuant to Laser Notice No. 50, dated June 24, 2007.		
<b>Radio Features</b>		
Frequency working center	<b>910MHz</b>	<b>433MHz</b>
Programmable Speed	40 kb/s 100 kb/s 500 kb/s (default)	19.2 kb/s 100 kb/s 500 kb/s (default)
Typical Range (in open air)	100m	from 50m (at 500 kb/s) to 100m (at 19.2kb/s)
Max number of devices per base station	16	

## Regulatory Information

### Compliance

This device must be opened by qualified personnel only.

### Power Supply

This device is intended to be supplied by a UL Listed/CSA Certified Power Unit marked "Class 2" or LPS power source rated 10-30 V DC, minimum 1 A, which supplies power directly to the cradle.



**Atención**

#### Características de la fuente de alimentación eléctrica.

<b>Entrada:</b>	100 - 240 Vca min 0.35A 50-60 Hz
<b>Salida:</b>	+5VDC, máx2.5A (-)Negativo al centro
<b>Entrada:</b>	100 - 240 Vca min 0.6A 50-60 Hz
<b>Salida:</b>	+12VDC, máx1.5A (-)Negativo al centro

Utilice en su red solo fuentes certificadas en Argentina.

El uso de fuentes de alimentación no compatibles puede resultar en riesgo de incendio o de choque eléctrico para el usuario.

#### Adaptador para Fuente de Poder Externa

### FCC Compliance

Modifications or changes to this equipment without the expressed written approval of Datalogic could void the authority to use the equipment.

This device complies with PART 15 of the FCC Rules. Operation is subject to the following two conditions: (1) This device may not cause harmful interference, and (2) this device must accept any interference received, including interference which may cause undesired operation.

### Radio Compliance

Contact the competent authority responsible for the management of radio frequency devices of your country to verify any possible restrictions or licenses required.



## China RoHS Statement

## Powerscan™ Base Station BC9180-XX China RoHS

PART	部件名称	Lead (Pb)	Mercury (Hg)	Cadmium (Cd)	Hexavalent Chromium (Cr(VI))	Polybrominated biphenyls (PBB)	Polybrominated diphenyl ethers (PBDE)
		有毒有害物质或元素					
Cable	电缆	铅	汞	镉	六价铬	多溴联苯	多溴二苯醚
Printed Circuit Board Assy	电路板组	X	O	O	O	O	O
Assembly, Module	光学组件	X	O	O	O	O	O
Power Supply	电源	X	O	O	O	O	O

**O:** 代表此种部件的所有均质材料中所含的该种有毒有害物质均低于中华人民共和国信息产业部所颁布的《电子信息产品中有毒有害物质的限量要求》(SJ/T 11363-2006) 规定的限量。

**X:** 代表此种部件所用的均质材料中, 至少有一类材料其所含的有毒有害物质高于中华人民共和国信息产业部所颁布的《电子信息产品中有毒有害物质的限量要求》(SJ/T 11363-2006) 规定的限量

EFUP determined by "Look-up Method" (scanner). 环保使用期限取决于“查表法” (扫描仪)



## WEEE Compliance



### Waste Electrical and Electronic Equipment (WEEE) Statement

#### English

For information about the disposal of Waste Electrical and Electronic Equipment (WEEE), please refer to the website at [www.datalogic.com](http://www.datalogic.com).

#### Italian

Per informazioni sullo smaltimento delle apparecchiature elettriche ed elettroniche consultare il sito Web [www.datalogic.com](http://www.datalogic.com).

#### French

Pour toute information relative à l'élimination des déchets électroniques (WEEE), veuillez consulter le site Internet [www.datalogic.com](http://www.datalogic.com).

#### German

Informationen zur Entsorgung von Elektro- und Elektronik- Altgeräten (WEEE) erhalten Sie auf der Webseite [www.datalogic.com](http://www.datalogic.com).

#### Spanish

Si desea información acerca de los procedimientos para el desecho de los residuos del equipo eléctrico y electrónico (WEEE), visite la página Web <http://www.datalogic.com>.

#### Portuguese

Para informações sobre a disposição de Sucatagem de Equipamentos Eléctricos e Eletrônicos (WEEE - Waste Electrical and Electronic Equipment), consultar o site web <http://www.datalogic.com>.

#### Chinese

有关处理废弃电气电子设备 (WEEE) 的信息, 请参考 Datalogic 公司的网站: <http://www.datalogic.com/>。

#### Japanese

廃電気電子機器 (W E E E) の処理についての関連事項は Datalogic のサイト <http://www.datalogic.com/>, をご参照下さい。

# Datalogic ADC Limited Factory Warranty

## Warranty Coverage

Datalogic warrants this product against defects in workmanship and materials, for a period of 3 years from the date of shipment, provided that the product is operated under normal and proper conditions. Datalogic ("Datalogic") hardware products are warranted against defects in material and workmanship under normal and proper use. The liability of Datalogic under this warranty is limited to furnishing the labor and parts necessary to remedy any defect covered by this warranty and restore the product to its normal operating condition. Repair or replacement of product during the warranty does not extend the original warranty term. Products are sold on the basis of specifications applicable at the time of manufacture and Datalogic has no obligation to modify or update products once sold.

If Datalogic determines that a product has defects in material or workmanship, Datalogic shall, at its sole option repair or replace the product without additional charge for parts and labor, or credit or refund the defective products duly returned to Datalogic. To perform repairs, Datalogic may use new or reconditioned parts, components, subassemblies or products that have been tested as meeting applicable specifications for equivalent new material and products. Customer will allow Datalogic to scrap all parts removed from the repaired product. The warranty period shall extend from the date of shipment from Datalogic for the duration published by Datalogic for the product at the time of purchase (Warranty period). Datalogic warrants repaired hardware devices against defects in workmanship and materials on the repaired assembly for a 90 day period starting from the date of shipment of the repaired product from Datalogic or until the expiration of the original warranty period, whichever is longer. Datalogic does not guarantee, and it is not responsible for, the maintenance of, damage to, or loss of configurations, data, and applications on the repaired units and at its sole discretion can return the units in the "factory default" configuration or with any software or firmware update available at the time of the repair (other than the firmware or software installed during the manufacture of the product). Customer accepts responsibility to maintain a back up copy of its software and data.

## Warranty Claims Process

In order to obtain service under the Factory Warranty, Customer must notify Datalogic of the claimed defect before the expiration of the applicable Warranty period and obtain from Datalogic a return authorization number (RMA) for return of the product to a designated Datalogic service center. If Datalogic determines Customer's claim is valid, Datalogic will repair or replace product without additional charge for parts and labor. Customer shall be responsible for packaging and shipping the product to the designated Datalogic service center, with shipping charges prepaid. Datalogic shall pay for the return of the product to Customer if the shipment is to a location within the country in which the Datalogic service center is located. Customer shall be responsible for paying all shipping charges, duties, taxes, and any other charges for products returned to any other locations. Failure to follow the applicable RMA policy, may result in a processing fee. Customer shall be responsible for return shipment expenses for products which Datalogic, at its sole discretion, determines are not defective or eligible for warranty repair.

## Warranty Exclusions

The Datalogic Factory Warranty shall not apply to:

- (i) any product which has been damaged, modified, altered, repaired or upgraded by other than Datalogic service personnel or its authorized representatives;
- (ii) any claimed defect, failure or damage which Datalogic determines was caused by faulty operations, improper use, abuse, misuse, wear and tear, negligence, improper storage or use of parts or accessories not approved or supplied by Datalogic;
- (iii) any claimed defect or damage caused by the use of product with any other instrument, equipment or apparatus;
- (iv) any claimed defect or damage caused by the failure to provide proper maintenance, including but not limited to cleaning the upper window in accordance with product manual;
- (v) any defect or damage caused by natural or man-made disaster such as but not limited to fire, water damage, floods, other natural disasters, vandalism or abusive events that would cause internal and external component damage or destruction of the whole unit, consumable items;

- (vi) any damage or malfunctioning caused by non-restoring action as for example firmware or software upgrades, software or hardware reconfigurations etc.;
- (vii) the replacement of upper window/cartridge due to scratching, stains or other degradation and/or
- (viii) any consumable or equivalent (e.g., cables, power supply, batteries, keypads, touch screen, triggers etc.).

## No Assignment

Customer may not assign or otherwise transfer its rights or obligations under this warranty except to a purchaser or transferee of product. No attempted assignment or transfer in violation of this provision shall be valid or binding upon Datalogic.

DATALOGIC'S LIMITED WARRANTY IS IN LIEU OF ALL OTHER WARRANTIES, EXPRESS OR IMPLIED, ORAL OR WRITTEN, STATUTORY OR OTHERWISE, INCLUDING, WITHOUT LIMITATION, ANY IMPLIED WARRANTIES OF MERCHANTABILITY, FITNESS FOR A PARTICULAR PURPOSE, OR NONINFRINGEMENT. DATALOGIC SHALL NOT BE LIABLE FOR ANY DAMAGES SUSTAINED BY CUSTOMER ARISING FROM DELAYS IN THE REPLACEMENT OR REPAIR OF PRODUCTS UNDER THE ABOVE. THE REMEDY SET FORTH IN THIS WARRANTY STATEMENT IS THE CUSTOMER'S SOLE AND EXCLUSIVE REMEDY FOR WARRANTY CLAIMS. UNDER NO CIRCUMSTANCES WILL DATALOGIC BE LIABLE TO CUSTOMER OR ANY THIRD PARTY FOR ANY LOST PROFITS, OR ANY INCIDENTAL, CONSEQUENTIAL IN-DIRECT, SPECIAL OR CONTINGENT DAMAGES REGARDLESS OF WHETHER DATALOGIC HAD ADVANCE NOTICE OF THE POSSIBILITY OF SUCH DAMAGES.

## Risk of Loss

Customer shall bear risk of loss or damage for product in transit to Datalogic. Datalogic shall assume risk of loss or damage for product in Datalogic's possession. In the absence of specific written instructions for the return of product to Customer, Datalogic will select the carrier, but Datalogic shall not thereby assume any liability in connection with the return shipment.

# Ergonomic Recommendations



## CAUTION

**In order to avoid or minimize the potential risk of ergonomic injury follow the recommendations below. Consult with your local Health & Safety Manager to ensure that you are adhering to your company's safety programs to prevent employee injury.**

- Reduce or eliminate repetitive motion
- Maintain a natural position
- Reduce or eliminate excessive force
- Keep objects that are used frequently within easy reach
- Perform tasks at correct heights
- Reduce or eliminate vibration
- Reduce or eliminate direct pressure
- Provide adjustable workstations
- Provide adequate clearance
- Provide a suitable working environment
- Improve work procedures

## Services and Support

Datalogic provides several services as well as technical support through its website. Log on to [www.datalogic.com](http://www.datalogic.com) and click on the links indicated for further information.

### Products

Search through the links to arrive at your product page where you can download specific **Manuals** and **Software & Utilities**, including:

- **Datalogic Aladdin™**, a multi-platform utility program that allows device configuration using a PC. It provides RS-232/USB-COM or Ethernet interface configuration, printing of configuration bar codes, and firmware upgrades.

### Service & Support

- **Technical Support** - Product documentation and programming guides and Technical Support Department in the world
- **Service Programs** - Warranty Extensions and Maintenance Agreements
- **Repair Services** - Flat Rate Repairs and Return Material Authorization (RMA) Repairs
- **Downloads** - Manuals & Documentation, Data Sheets, Product Catalogues, etc.

### Contact Us

- Information Request Form and Sales & Service Network

# NOTES

# NOTES

# DATALOGIC

## DECLARATION OF CONFORMITY

CE 14

Datalogic ADC Srl, Via S. Vitalino, 13  
Lippo di Calderara di Reno (BO) 40012 Italy

EC-101  
Rev.: 1  
Pag.: 1 di 1

La presente dichiarazione di conformità è rilasciata sotto la responsabilità esclusiva di Datalogic ADC Srl per:

This Declaration of Conformity is issued under the sole responsibility of Datalogic ADC Srl for:

Cette déclaration de conformité est établie sous la seule responsabilité de Datalogic Srl pour:

Diese Konformitätserklärung wird unter der alleinigen Verantwortung des Datalogic ADC Srl erteilt für:

Esta declaración de conformidad se expide bajo la exclusiva responsabilidad de Datalogic ADC Srl para:

**PowerScan PM9500 ; Cordless Barcode Reader  
BC9XY0-433 ; Cordless Base Station/Charger**

*e tutti i suoi modelli  
and all its models  
et tous ses modèles  
und seine Modelle  
y todos sus modelos*

sono conformi alle Direttive del Consiglio Europeo sottoelencate:

are in conformity with the requirements of the European Council Directives listed below:

sont conformes aux spécifications des Directives de l'Union Européenne ci-dessous:

den nachstehenden angeführten Direktiven des Europäischen Rats:

cumple con los requisitos de las Directivas del Consejo Europeo, según la lista siguiente:

**1999/5/EC - R&TTE Directive**

**2011/65/EU - RoHS Directive**

Questa dichiarazione è basata sulla conformità dei prodotti alle norme seguenti:

This declaration is based upon compliance of the products to the following standards:

Cette déclaration repose sur la conformité des produits aux normes suivantes:

Diese Erklärung basiert darauf, daß das Produkt den folgenden Normen entspricht:

Esta declaración se basa en el cumplimiento de los productos con las siguientes normas:

**ETSI EN 301 489-3 v1.4.1, AUGUST 2002 :** *ELECTROMAGNETIC COMPATIBILITY AND RADIO SPECTRUM MATTERS (ERM); ELECTROMAGNETIC COMPATIBILITY (EMC) STANDARD FOR RADIO EQUIPMENT AND SERVICES; PART 3: SPECIFIC CONDITIONS FOR SHORT-RANGE DEVICES (SRD) OPERATING ON FREQUENCIES BETWEEN 9KHZ AND 40GHZ*

**EN 301 489-1 V1.8.1, APRIL 2008 :** *ELECTROMAGNETIC COMPATIBILITY AND RADIO SPECTRUM MATTERS (ERM); ELECTROMAGNETIC COMPATIBILITY (EMC) STANDARD FOR RADIO EQUIPMENT AND SERVICES; PART 1: COMMON TECHNICAL REQUIREMENTS*

**ETSI EN 300 220-2 V2.1.2, JUNE 2007 :** *ELECTROMAGNETIC COMPATIBILITY AND RADIO SPECTRUM MATTERS (ERM); SHORT RANGE DEVICES (SRD); RADIO EQUIPMENT TO BE USED IN THE 25MHZ TO 1000MHZ FREQUENCY RANGE WITH POWER LEVELS RANGING UP TO 500MW; PART 2: HARMONIZED EN COVERING ESSENTIAL REQUIREMENTS UNDER ARTICLE 3.2 OF THE R&TTE DIRECTIVE*

**EN 60950-1, DECEMBER 2006 + AMENDMENT A11:2009 + AMENDMENT A1:2010 + AMENDMENT A12:2011** *INFORMATION TECHNOLOGY EQUIPMENT - SAFETY - PART 1 : GENERAL REQUIREMENTS*

**EN 50581, SEPTEMBER 2012 :** *TECHNICAL DOCUMENTATION FOR THE ASSESSMENT OF ELECTRICAL AND ELECTRONIC PRODUCTS WITH RESPECT TO THE RESTRICTION OF HAZARDOUS SUBSTANCES*

Lippo di Calderara, August 29th , 2013

RUGGERO CACIOPPO  
QUALITY & RELIABILITY MANAGER - EUROPE

*Ruggero Cacioppo*



[www.datalogic.com](http://www.datalogic.com)

©2013-2014 Datalogic, Inc. ■ All rights reserved.  
Datalogic and the Datalogic logo are registered  
trademarks of Datalogic S.p.A. in many countries,  
including the U.S.A. and the E.U.

**Datalogic ADC, Inc.**

959 Terry Street | Eugene | OR 97402 | USA  
Telephone: (1) 541-683-5700 | Fax: (1) 541-345-7140



820064514

(Rev A)

July 2014