

**ebm-papst St. Georgen GmbH & Co. KG**

Hermann-Papst-Str. 1

D-78112 St. Georgen

Phone +49 (0) 7724 81-0

Fax +49 (0) 7724 81-1309

info2@de.ebmpapst.com

www.ebmpapst.com

Nominal data

Type	514 F	
Nominal voltage	VDC	24
Nominal voltage range	VDC	21.6 .. 26.4
Speed (rpm)	min ⁻¹	5000
Power consumption	W	0.9
Min. ambient temperature	°C	-20
Max. ambient temperature	°C	70
Air flow	m ³ /h	20
Sound power level	B	4.5
Sound pressure level	dB(A)	30

ml = Max. load · me = Max. efficiency · fa = Free air · cs = Customer specification · ce = Customer equipment
 Subject to change



Technical description

Weight	0.027 kg
Dimensions	50 x 50 x 15 mm
Impeller material	Glass-fiber reinforced PA plastic
Housing material	Glass-fiber reinforced PBT plastic
Airflow direction	Exhaust over struts
Direction of rotation	Counterclockwise, viewed toward rotor
Storage	Sintec sleeve bearing
Service life L10 at 20 °C	50000 h
Service life L10 at 60 °C	20000 h
Cable	Leads AWG 28, TR 64, stripped and tin-plated.
Motor protection	Protection against reverse polarity and blocked rotor.
Locked-rotor protection	Impedance protection
Approval	VDE, CSA, UL, CE
Option	Possible custom designs: Speed signal Go / No-go alarm PWM control input Moisture protection



Product drawing

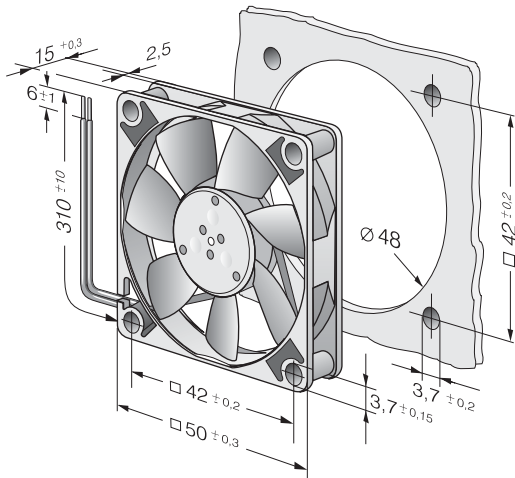

Curves: Air performance

