

# NH fuse-links gG 500VAC

top indicator/live tags size 4, 4a

## IEC LV NH fuse links with blade contacts

The NH system is classified among plug-in fuse systems and is composed of:

- fuse-base, (possibly including terminal covers and phase barriers)
- fuse-link with blade contact
- fuse-link replacement device (LV HRC fuse puller)

Since the design of this system cannot guarantee non-interchangeability of rated current,

it must be handled by a qualified professional.

### Features Benefits

- Dimensions in accordance with DIN 43 620
- Live tags
- Top indicator
- Lead free contact blades
- 0% cadmium

### Applications

- gG: General purpose (protection of cables and LV-networks)

### Technical data overview

Volt (VAC)	500 VAC
Ampere Range (A)	400 ... 1600 A
Size per Standard	Size 4 and 4a
Speed/Characteristic	gG
I.R. AC (kA)	120 kA



### Standards

IEC/EN 60269-1 and -2  
VDE 0636 Part 201



# NH fuse-links gG 500VAC

top indicator/live tags size 4, 4a

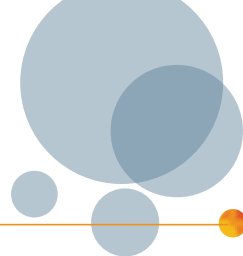

## Product range



NH4GG50V1250-8

### Size 4

Catalog number	Reference number	Rated current $I_n$	Power dissipation at $I_n$	Width	Weight	Package
NH4GG50V630-8	X1034514	630 A	38 W	100 mm	2.1 kg	1
NH4GG50V800-8	Y1034515	800 A	56 W	100 mm	2.1 kg	1
NH4GG50V1000-8	Z1034516	1000 A	65 W	100 mm	2.1 kg	1
NH4GG50V1250-8	A1034517	1250 A	61 W	100 mm	2.1 kg	1



NH4AGG50V1600-8

### Size 4a

Catalog number	Reference number	Rated current $I_n$	Power dissipation at $I_n$	Width	Weight	Package
NH4AGG50V400-8	B1034518	400 A	31 W	98 mm	2.58 kg	1
NH4AGG50V500-8	C1034519	500 A	45 W	98 mm	2.58 kg	1
NH4AGG50V630-8	D1034520	630 A	47 W	98 mm	2.58 kg	1
NH4AGG50V710-8	E1034521	710 A	57 W	98 mm	2.58 kg	1
NH4AGG50V800-8	F1034522	800 A	67 W	98 mm	2.58 kg	1
NH4AGG50V900-8	G1034523	900 A	68 W	98 mm	2.58 kg	1
NH4AGG50V1000-8	H1034524	1000 A	69 W	98 mm	2.58 kg	1
NH4AGG50V1250-8	J1034525	1250 A	84 W	98 mm	2.58 kg	1
NH4AGG50V1600-8	K1034526	1600 A	106 W	98 mm	2.58 kg	1

## Technical Data

	size 4	size 4a
Rated current	630 ... 1250 A	400 ... 1600 A
Rated breaking capacity AC	120 kA	120 kA
Rated voltage AC	500 V	500 V

# NH fuse-links gG 500VAC

top indicator/live tags size 4, 4a

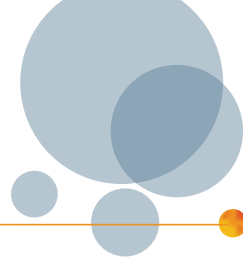

## Time current characteristic curves

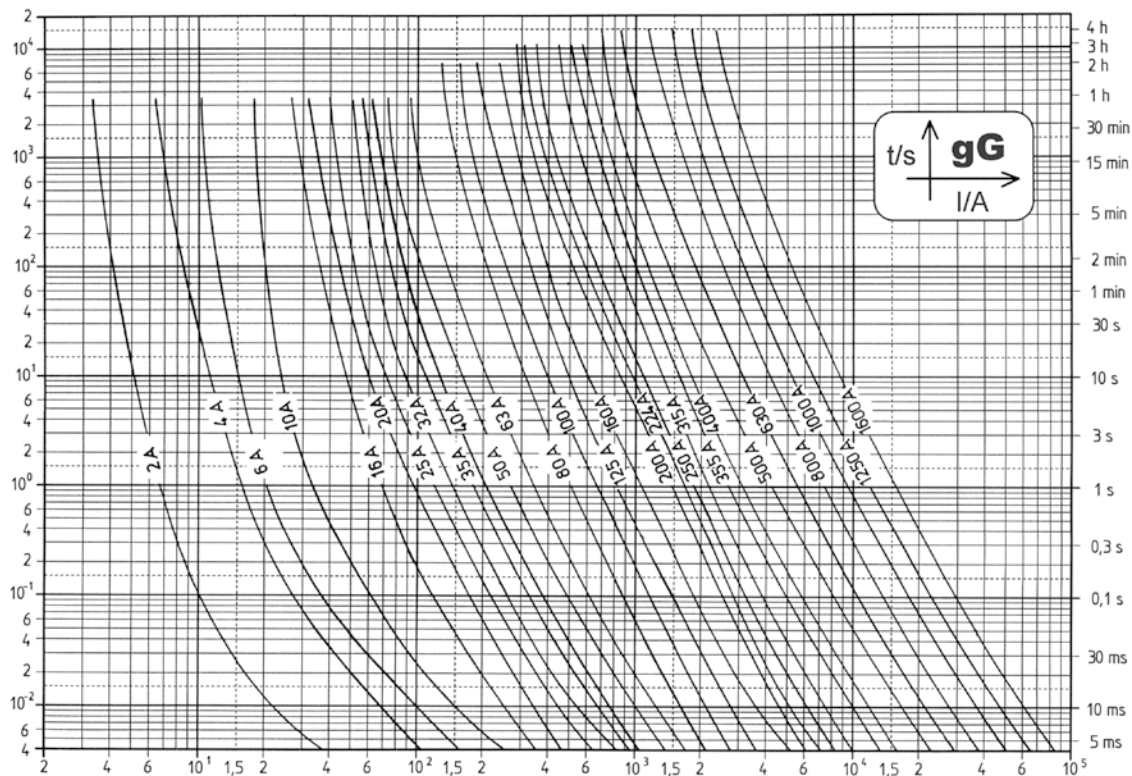

# NH fuse-links gG 500VAC

top indicator/live tags size 4, 4a

## Current limiting diagram

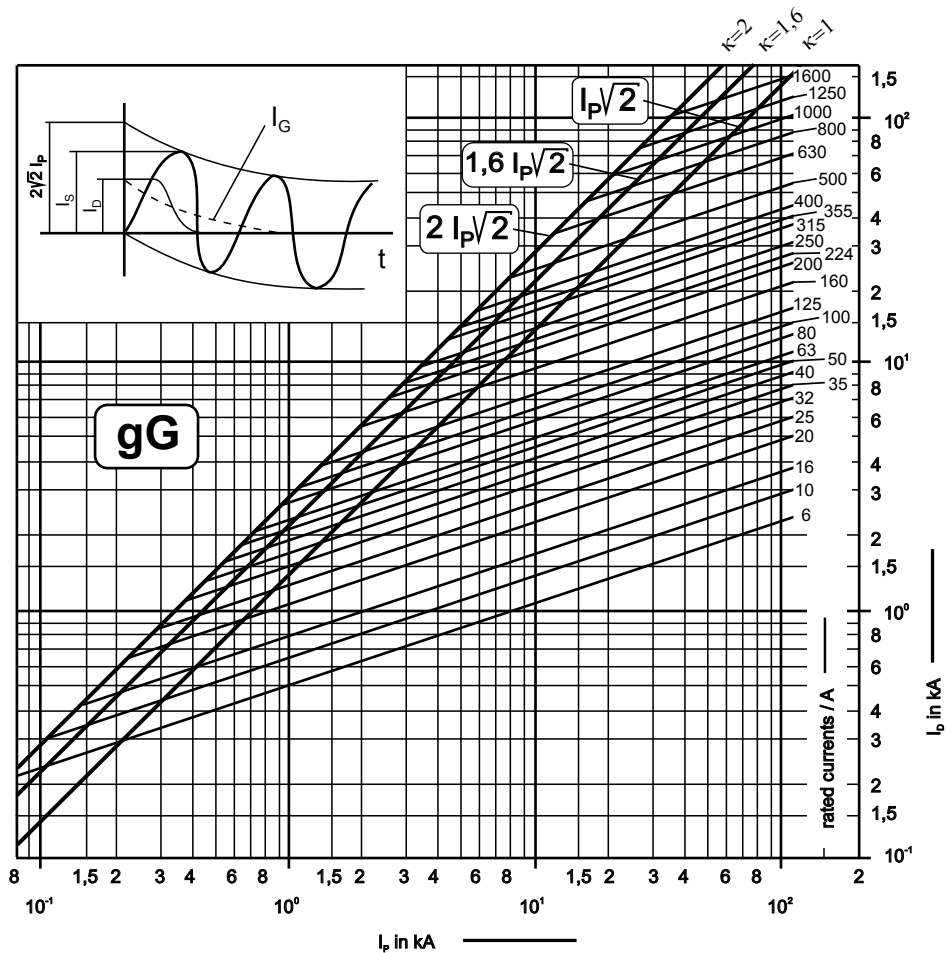

# NH fuse-links gG 500VAC

top indicator/live tags size 4, 4a

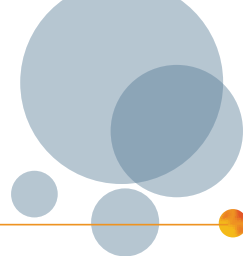

## Dimensions

IEC LV NH-fuse link size 4 with top indicator (M02038)

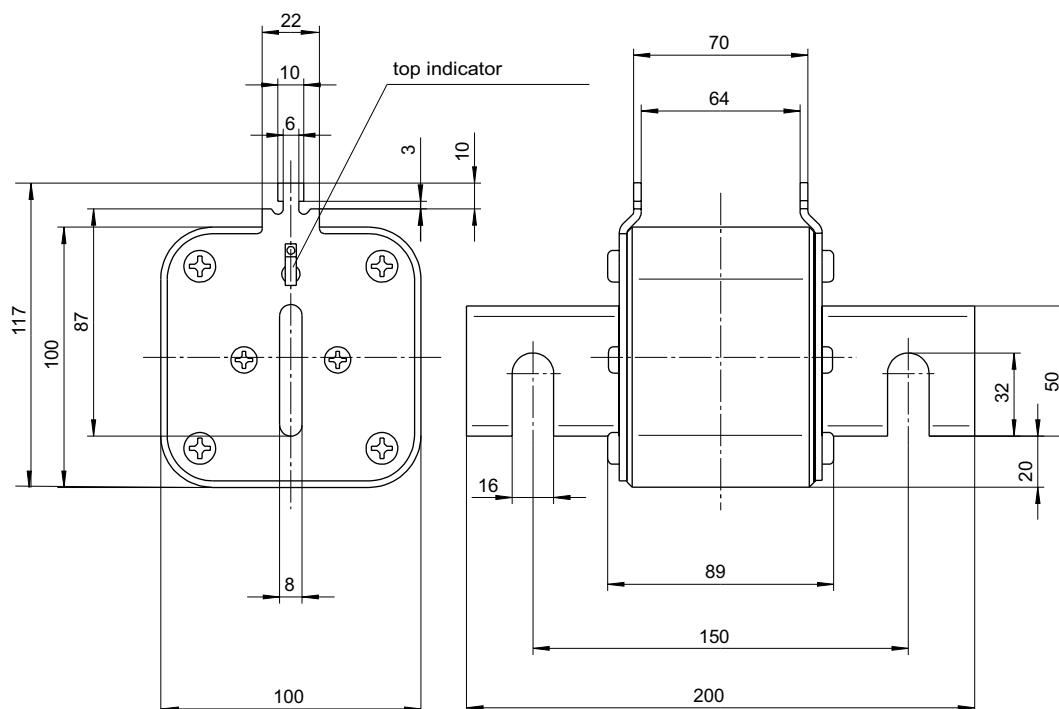

Dimensions in mm

# NH fuse-links gG 500VAC

top indicator/live tags size 4, 4a

## Dimensions

IEC LV NH-fuse link size 4a with top indicator (M02037)

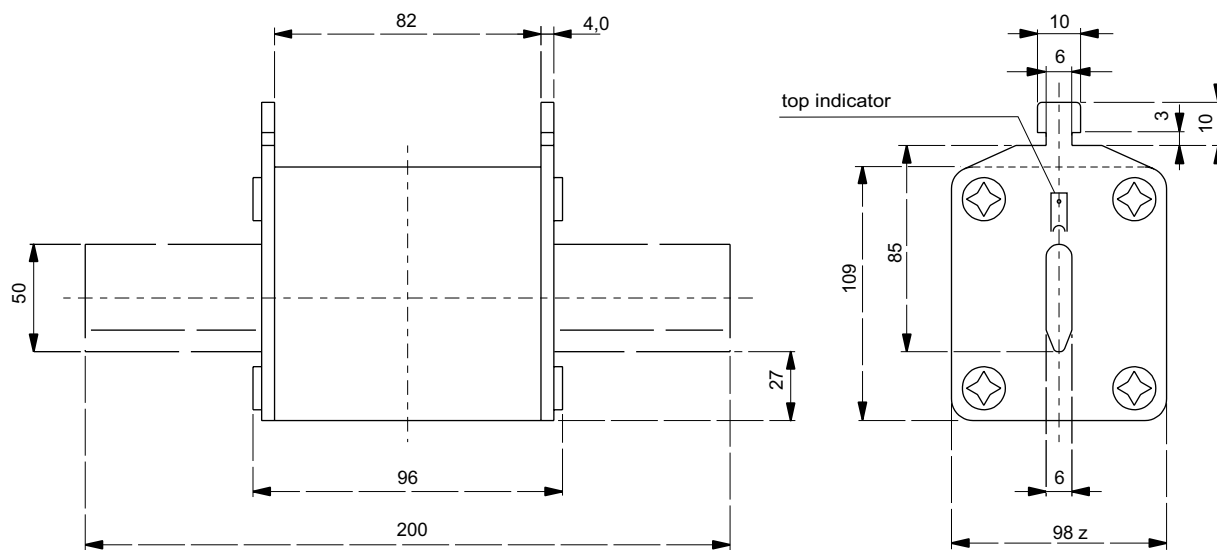

Dimensions in mm