

**RECHNER  
SENSORS**

***CAPACITIVE  
SENSORS  
KAS***

***Series 26***

Level Control

- Food Industry
- Pharmaceutical Industry
- Semiconductor Industry
- Chemical Industry





Intertek



Registrier-Nr.: 1327-01



For all transactions, the latest version of the „General Conditions of Sale and Delivery for Products and Services of the Electrical Industry ZVEI“ shall apply, along with the supplementary conditions „extended reservation of proprietary rights“, together with the supplements listed on our order confirmations and/or invoices.

All specifications are subject to change without notice. Reprint, even in part, only with our consent.  
© RECHNER Germany 11/2011 GB - Printed in EU, all rights reserved.

#### **Edition November 2011**

With publication of this catalogue all former printed catalogues about RECHNER KAS-26... series capacitive sensors are invalid.

## CAPACITIVE SENSORS - SERIES 26 WITH SEMICIRCULAR ACTIVE AREA

Capacitive sensors detect metals or non-metals, which exceed a certain capacity by approaching the active area. The higher the dielectric constant is of the material to be detected, the higher is the achievable sensing distance. A further relevant aspect for the sensing distance is the electronic circuit and the assembly of the sensor electrodes. These specific sensor or general brand type physical and electronic differences are the decisive parameters that affect quality and performance, and separate the average capacitive sensor from High Performance Sensors.

With this brochure we present you one of our high lights: the series 26 capacitive sensors.

The semicircular active area is a clear sign, that this is no common sensor. The special feature of these sensors is not only the semicircular construction, it is especially the high performance circuit and the optimal electrode form and electrode assembly.

The series 26 capacitive sensors are suitable for level control of most different products. They are used in the Semiconductor Industry, Chemical Industry and in the Food Industry. Therefore these sensors are available with different process connections, like 1", M22, Triclamp, with F30 fitting and with modified body sizes for standard plastic pipe fitting systems. There are models for 10...35 V DC and for 20...250 V AC / DC. To complete this range there are models with ATEX certificate for use in areas with danger of explosion, dust zone 20 or gas zone 1.

### HOUSING MATERIAL

The plastic materials used for the housings of the sensors are suitable for applications in the food and pharmaceutical industry:

- PTFE (polytetrafluor ethylene) (FDA 21 CFR 177.1550)
- PEEK (Polyetheretherketon) (FDA 21 CFR 177.2415)
- PP (Polypropylen) (FDA 21 CFR 177.1520)

The versions for ambient temperature of +100°C are capable of CIP (Cleaning In Process) up to 121 °C. Cleaning or sterilization is permitted within this temperature range for parts that are in contact with the products.

### NON FLUSH MOUNTING

All sensors shown in this brochure are for non-flush mounting. That means they are designed for applications where the active area of the sensor is in contact with the material to be detected.

With this kind of level control the sensor head (active area) is completely immersed into the powder, granulate or liquid.

These capacitive sensors are well accepted as sensors that are reliable, and there are a large number of versions to suit many applications in the processing industry and throughout mechanical engineering. Nowadays they are indispensable.

For further information about capacitive sensors please take from our main catalogue or from our web site [www.rechner-sensors.com](http://www.rechner-sensors.com).

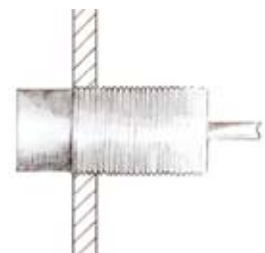

## CAPACITIVE SENSORS Series 26

Housing

Ø 20,3 mm

Ø 22 mm



Technical data	Non-flush mountable	Non-flush mountable
Sensing distance $S_n$	5 mm	5 mm
Sensing distance min. / max. adjustable	0...20 mm	0...20 mm
	<b>Type description</b>	<b>Art.-No.</b>
<b>Type NPN antivalent</b>	<b>KAS-70-26-A-M22-M30-PTFE</b>	-
<b>Type PNP antivalent</b>	<b>KAS-80-26-A-M22-M30-PTFE</b>	<b>KA 0431</b>
Certificates	CE, RoHS, UL-CSA	CE, RoHS, UL-CSA
Operating voltage ( $U_b$ )	10...35 V DC	10...35 V DC
Output current ( $I_o$ )	2 x 250 mA	2 x 250 mA
No load current ( $I_o$ )	< 15 mA	< 15 mA
Frequency of operating cycles max.	50 Hz	50 Hz
Permitted ambient temperature	-25...+70 °C / CIP 121 °C (zero-current)	-25...+100 °C / CIP 121 °C (zero-current)
LED display	Yes	Yes
Protective circuit	Yes	Yes
Norm	IEC 60947-5-2	IEC 60947-5-2
Degree of protection IEC 60529*	IP 67**	IP 67*
Connection	3 m cable, PVC, 4 x 0,5 mm <sup>2</sup>	Connector M 12 x 1
Housing material	PTFE (FDA 21 CFR 177.1550)	PTFE (FDA 21 CFR 177.1550)
Active surface	PTFE (FDA 21 CFR 177.1550)	PTFE (FDA 21 CFR 177.1550)
Lid	PTFE (FDA 21 CFR 177.1550)	PEEK (FDA 21 CFR 177.2415)

\*With sealed potentiometer screw

\*\*IP 68 with use of the protection set, see page 17

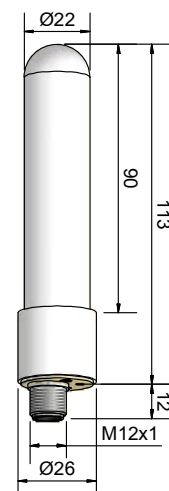
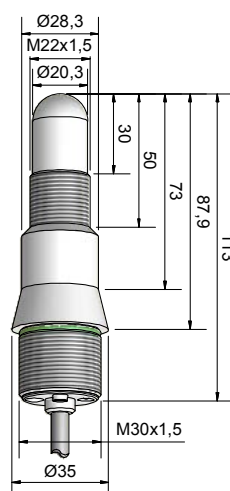
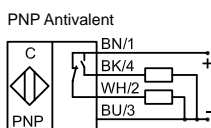
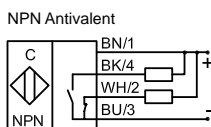

## CAPACITIVE SENSORS Series 26

Ø 26 mm



Ø 26 mm



Ø 26 mm



Non-flush mountable		Non-flush mountable		Non-flush mountable	
5 mm		5 mm		5 mm	
0...20 mm		0...20 mm		0...20 mm	
Type description	Art.-No.	Type description	Art.-No.	Type description	Art.-No.
KAS-70-26-A-PTFE-M30-Y5	-	KAS-70-26-A-PTFE-1"	KA 1078	KAS-70-26-A-PTFE-1"-Y5	KA 0844
KAS-80-26-A-PTFE-M30-Y5	KA 0689	KAS-80-26-A-PTFE-1"	813 100	KAS-80-26-A-PTFE-1"-Y5	KA 0642
CE, RoHS, UL-CSA		CE, RoHS, UL-CSA		CE, RoHS, UL-CSA	
10...35 V DC		10...35 V DC		10...35 V DC	
2 x 250 mA		2 x 250 mA		2 x 250 mA	
< 15 mA		< 15 mA		< 15 mA	
50 Hz		50 Hz		50 Hz	
-25...+70 °C / CIP 121 °C (zero-current)		-25...+70 °C / CIP 121 °C (zero-current)		-25...+70 °C / CIP 121 °C (zero-current)	
Yes		Yes		Yes	
Yes		Yes		Yes	
IEC 60947-5-2		IEC 60947-5-2		IEC 60947-5-2	
IP 67*		IP 67*		IP 67*	
Connector M 12 x 1		2 m cable, PVC, 4 x 0,5 mm <sup>2</sup>		Connector M 12 x 1	
PTFE (FDA 21 CFR 177.1550)		PTFE (FDA 21 CFR 177.1550)		PTFE (FDA 21 CFR 177.1550)	
PTFE (FDA 21 CFR 177.1550)		PTFE (FDA 21 CFR 177.1550)		PTFE (FDA 21 CFR 177.1550)	
PA / PPO		PA / PPO		PA / PPO	

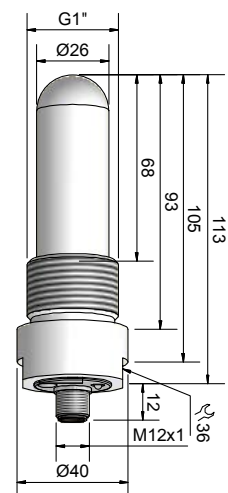
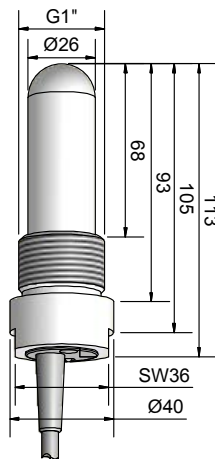
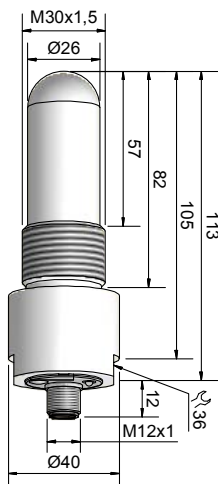

## CAPACITIVE SENSORS Series 26

Housing

Ø 26 mm

Ø 26 mm



Technical data	Non-flush mountable		Non-flush mountable	
Sensing distance $S_n$	5 mm		5 mm	
Sensing distance min. / max. adjustable	0...20 mm		0...20 mm	
	Type description	Art.-No.	Type description	Art.-No.
Type NPN antivalent	KAS-70-26-A-PTFE-1"-100°C	-	KAS-70-26-A-PTFE-1"-100°C-Y5	-
Type PNP antivalent	KAS-80-26-A-PTFE-1"-100°C	KA 0277	KAS-80-26-A-PTFE-1"-100°C-Y5	KA 0688
Certificates	CE, RoHS, UL-CSA		CE, RoHS, UL-CSA	
Operating voltage ( $U_b$ )	10...35 V DC		10...35 V DC	
Output current ( $I_o$ )	2 x 250 mA		2 x 250 mA	
No load current ( $I_o$ )	< 15 mA		< 15 mA	
Frequency of operating cycles max.	50 Hz		50 Hz	
Permitted ambient temperature	-25...+100 °C / CIP 121 °C (zero-current)		-25...+100 °C / CIP 121 °C (zero-current)	
LED display	Yes		Yes	
Protective circuit	Yes		Yes	
Norm	IEC 60947-5-2		IEC 60947-5-2	
Degree of protection IEC 60529*	IP 67*		IP 67*	
Connection	2 m cable, PVC, 4 x 0,5 mm <sup>2</sup>		Connector M 12 x 1	
Housing material	PTFE (FDA 21 CFR 177.1550)		PTFE (FDA 21 CFR 177.1550)	
Active surface	PTFE (FDA 21 CFR 177.1550)		PTFE (FDA 21 CFR 177.1550)	
Lid	PA / PPO		PA / PPO	

\*With sealed potentiometer screw

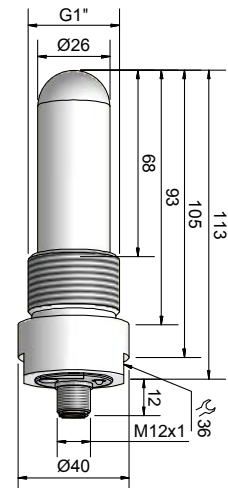
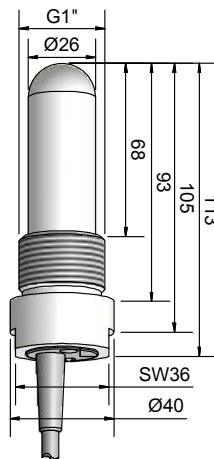
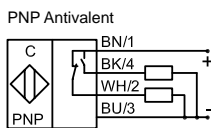
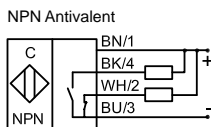

## CAPACITIVE SENSORS Series 26

Ø 26 mm



Ø 26 mm



Ø 26 mm



Non-flush mountable		Non-flush mountable		Non-flush mountable	
5 mm		5 mm		5 mm	
0...20 mm		0...20 mm		0...20 mm	
Type description	Art.-No.	Type description	Art.-No.	Type description	Art.-No.
KAS-70-26-A-PTFE-1"-CIP160	-	KAS-70-26-A-200-PTFE-1"	-	KAS-70-26-A-200-PTFE-1"-Y5	-
KAS-80-26-A-PTFE-1"-CIP160	KA 0647	KAS-80-26-A-200-PTFE-1"	KA 0653	KAS-80-26-A-200-PTFE-1"-Y5	KA 0686
CE, RoHS, UL-CSA		CE, RoHS, UL-CSA		CE, RoHS, UL-CSA	
10...35 V DC		10...35 V DC		10...35 V DC	
2 x 250 mA		2 x 250 mA		2 x 250 mA	
< 15 mA		< 15 mA		< 15 mA	
50 Hz		50 Hz		50 Hz	
-25...+70 °C / CIP 160 °C (zero-current)		-25...+70 °C / CIP 121 °C (zero-current)		-25...+70 °C / CIP 121 °C (zero-current)	
Yes		Yes		Yes	
Yes		Yes		Yes	
IEC 60947-5-2		IEC 60947-5-2		IEC 60947-5-2	
IP 67*		IP 67**		IP 67*	
2 m cable, PVC, 4 x 0,5 mm <sup>2</sup>		2 m cable, PVC, 4 x 0,5 mm <sup>2</sup>		Connector M 12 x 1	
PTFE (FDA 21 CFR 177.1550)		PTFE (FDA 21 CFR 177.1550)		PTFE (FDA 21 CFR 177.1550)	
PTFE (FDA 21 CFR 177.1550)		PTFE (FDA 21 CFR 177.1550)		PTFE (FDA 21 CFR 177.1550)	
PA / PPO		PC (FDA 21 CFR 177.1580)		PA / PPO	

\*\*IP 68 with use of the protection set, see page 17

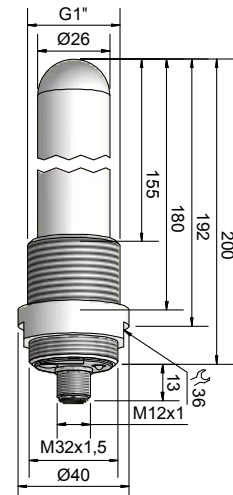
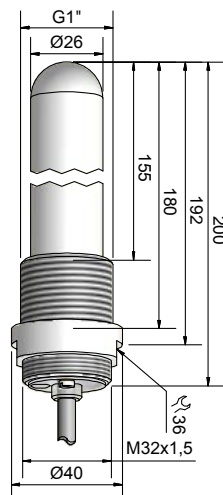
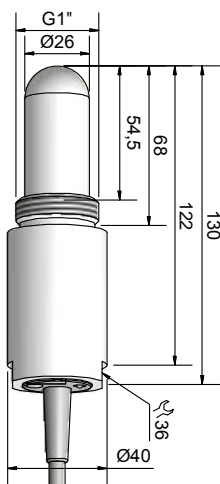

## CAPACITIVE SENSORS Series 26

Housing

Ø 26 mm

Ø 26 mm



Technical data	Non-flush mountable		Non-flush mountable	
Sensing distance $S_n$	5 mm		5 mm	
Sensing distance min. / max. adjustable	0...20 mm		0...20 mm	
	Type description	Art.-No.	Type description	Art.-No.
Type NPN antivalent	KAS-70-26-A-200-PTFE-1"-100°C-Y5	-	KAS-70-26-A-300-PTFE-1"-Y5	-
Type PNP antivalent	KAS-80-26-A-200-PTFE-1"-100°C-Y5	KA 0687	KAS-80-26-A-300-PTFE-1"-Y5	KA 0682
Certificates	CE, RoHS, UL-CSA		CE, RoHS, UL-CSA	
Operating voltage ( $U_b$ )	10...35 V DC		10...35 V DC	
Output current ( $I_o$ )	2 x 250 mA		2 x 250 mA	
No load current ( $I_o$ )	< 15 mA		< 15 mA	
Frequency of operating cycles max.	50 Hz		50 Hz	
Permitted ambient temperature	-25...+100 °C / CIP 121 °C (zero-current)		-25...+70 °C / CIP 121 °C (zero-current)	
LED display	Ja		Ja	
Protective circuit	Ja		Ja	
Norm	IEC 60947-5-2		IEC 60947-5-2	
Degree of protection IEC 60529*	IP 67**		IP 67*	
Connection	Connector M 12 x 1		Connector M 12 x 1	
Housing material	PTFE (FDA 21 CFR 177.1550)		PTFE (FDA 21 CFR 177.1550)	
Active surface	PTFE (FDA 21 CFR 177.1550)		PTFE (FDA 21 CFR 177.1550)	
Lid	PA / PPO		PA / PPO	

\*With sealed potentiometer screw

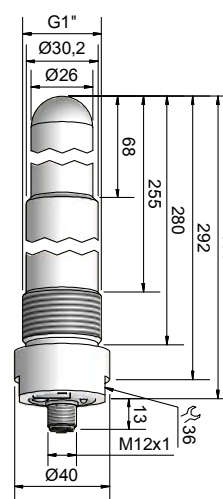
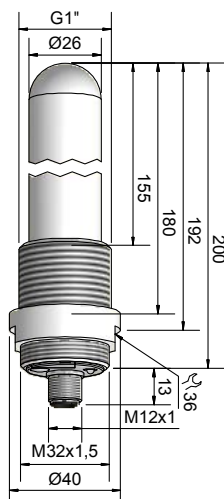
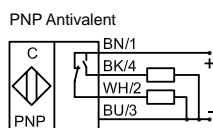
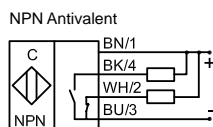



## CAPACITIVE SENSORS Series 26

Ø 26 mm



Ø 26 mm



Ø 25,5 mm



Non-flush mountable		Non-flush mountable		Non-flush mountable	
5 mm		5 mm		5 mm	
0...20 mm		0...20 mm		0...20 mm	
Type description	Art.-No.	Type description	Art.-No.	Type description	Art.-No.
KAS-70-26-A-PTFE-Tri-100°C	KA 1025	KAS-70-26-A-PTFE-Tri-100°C-Y5	-	KAS-70-26-A-PTFE-PFS2	-
KAS-80-26-A-PTFE-Tri-100°C	KA 0415	KAS-80-26-A-PTFE-Tri-100°C-Y5	KA 0662	KAS-80-26-A-PTFE-PFS2	KA 0566
CE, RoHS, UL-CSA		CE, RoHS, UL-CSA		CE, RoHS, UL-CSA	
10...35 V DC		10...35 V DC		10...35 V DC	
2 x 250 mA		2 x 250 mA		2 x 250 mA	
< 15 mA		< 15 mA		< 15 mA	
50 Hz		50 Hz		50 Hz	
-25...+100 °C / CIP 121 °C (zero-current)		-25...+100 °C / CIP 121 °C (zero-current)		-25...+100 °C / CIP 121 °C (zero-current)	
Ja		Ja		Ja	
Ja		Ja		Ja	
IEC 60947-5-2		IEC 60947-5-2		IEC 60947-5-2	
IP 67*		IP 67*		IP 67*	
2 m cable, PVC, 4 x 0,5 mm <sup>2</sup>		Connector M 12 x 1		2 m cable, PVC, 4 x 0,5 mm <sup>2</sup>	
PTFE (FDA 21 CFR 177.1550)		PTFE (FDA 21 CFR 177.1550)		PTFE (FDA 21 CFR 177.1550)	
PTFE (FDA 21 CFR 177.1550)		PTFE (FDA 21 CFR 177.1550)		PTFE (FDA 21 CFR 177.1550)	
PA / PPO		PA / PPO		PA / PPO	
Accessories, see page 17		Accessories, see page 17		Accessories, see page 17	

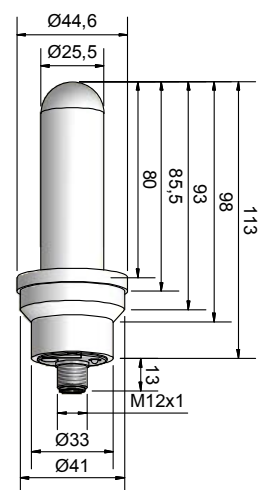
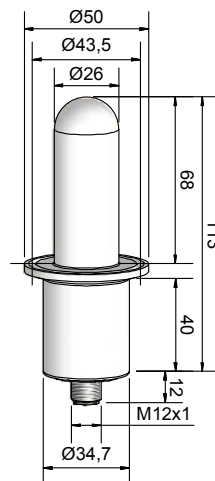
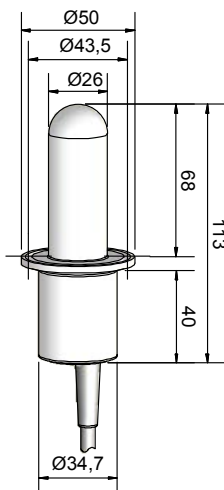

## CAPACITIVE SENSORS Series 26

Housing

Ø 26 mm

Ø 26 mm



Technical data	Non-flush mountable		Non-flush mountable	
Sensing distance $S_n$	5 mm		5 mm	
Sensing distance min. / max. adjustable	0...20 mm		0...20 mm	
	Type description	Art.-No.	Type description	Art.-No.
Type NPN antivalent	KAS-70-26-A-PTFE-PFS1-Y5	-	KAS-70-26-A-PEEK-1"-HG-Y5	-
Type PNP antivalent	KAS-80-26-A-PTFE-PFS1-Y5	KA 0549	KAS-80-26-A-PEEK-1"-HG-Y5	KA 0764
Certificates	CE, RoHS, UL-CSA		CE, RoHS, UL-CSA	
Operating voltage ( $U_b$ )	10...35 V DC		10...35 V DC	
Output current ( $I_o$ )	2 x 250 mA		2 x 250 mA	
No load current ( $I_o$ )	< 15 mA		< 15 mA	
Frequency of operating cycles max.	50 Hz		50 Hz	
Permitted ambient temperature	-25...+100 °C / CIP 121 °C (zero-current)		-25...+70 °C / CIP 121 °C (zero-current)	
LED display	Yes		Yes	
Protective circuit	Yes		Yes	
Norm	IEC 60947-5-2		IEC 60947-5-2	
Degree of protection IEC 60529*	IP 67*		IP 67*	
Connection	Connector M 12 x 1		Connector M 12 x 1	
Housing material	PTFE (FDA 21 CFR 177.1550)		PEEK (FDA 21 CFR 177.2415)	
Active surface	PTFE (FDA 21 CFR 177.1550)		PEEK (FDA 21 CFR 177.2415)	
Lid	PA / PPO		PA / PPO	

\*With sealed potentiometer screw

Accessories, see page 17

Accessories, see page 18

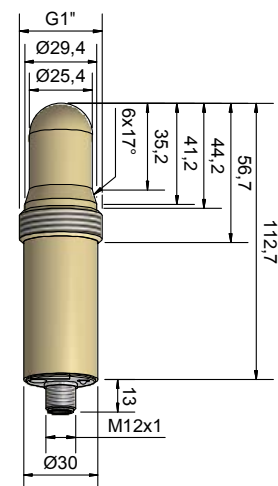
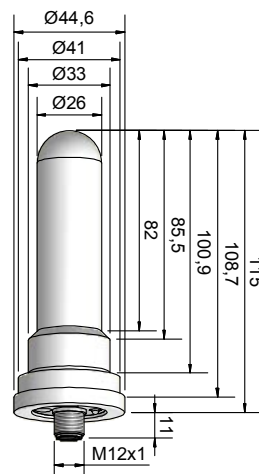
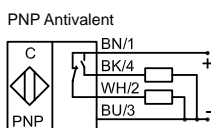
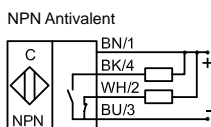

## CAPACITIVE SENSORS NAMUR Series 26 ATEX

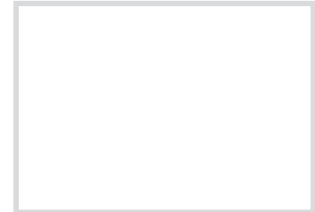
**Housing**
**Ø 26 mm**

<b>Technical data</b>	Non-flush mountable	
Sensing distance Sn	5 mm	
Sensing distance min./max. adjustable	0...15 mm	
	<b>Type description</b>	<b>Art.-No.</b>
<b>Type</b>	<b>KAS-40-26-N-PTFE-1"</b>	<b>KA 0740</b>
Certificates	CE, RoHS UL-CSA	
ATEX Certificate No.	DMT 03 ATEX E 048	
ATEX	Ex II 2 G EEx ia IIC T1-T6	
IECEX Certificate No.	IECEX BVS 07.0031	
IECEX	Ex ia IIC T1 - T6	
Operating voltage (U <sub>b</sub> )	U <sub>i</sub> = 15 V DC	
Output current active surface free	< typ. 1,5 mA	
Output current active surface covered	> typ. 3 mA	
Self-inductance (L)	0,2 mH	
Frequency of operating cycles max.	50 Hz	
Permitted ambient temperature	0...+70 °C	
LED display	Yes	
Protective circuit	Yes	
Norm	IEC 60947-5-6	
Degree of protection IEC 60529*	IP 67*	
Connection	2 m cable, PUR, 2 x 0,75 mm <sup>2</sup>	
Housing material	PTFE (FDA 21 CFR 177.1550)	
Active surface	PTFE (FDA 21 CFR 177.1550)	
Lid	PA / PPO	

\*With sealed potentiometer screw

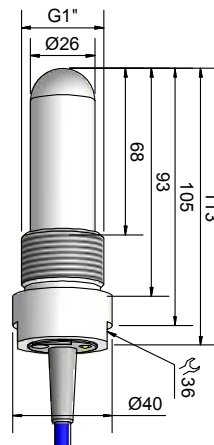
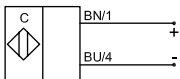

## CAPACITIVE SENSORS Series 26 ATEX StEx

Housing

Ø 26 mm

Ø 26 mm



Technical data	Non-flush mountable		Non-flush mountable	
Sensing distance $S_n$	5 mm		5 mm	
Sensing distance min. / max. adjustable	0...20 mm		0...20 mm	
	Type description	Art.-No.	Type description	Art.-No.
Type NPN antivalent	KAS-70-26-A-PTFE-1"-StEx-N	KA 0824	KAS-70-26-A-PTFE-1"-Y5-StEx-N	-
Type PNP antivalent	KAS-80-26-A-PTFE-1"-StEx-N	KA 0264	KAS-80-26-A-PTFE-1"-Y5-StEx-N	KA 0655
Certificates	CE, RoHS, UL-CSA		CE, RoHS, UL-CSA	
ATEX Certificate No.	DMT 01 ATEX E 157		DMT 01 ATEX E 157	
ATEX	Ex II 1/2D IP67 T 101 °C Ex II 2G EEx m II T4		Ex II 1/2D Ex tD A20/21 IP67 T 101 °C	
IECEX Certificate No.	IECEX BVS 07.0015		IECEX BVS 07.0015	
IECEX	Ex tD A20/21 IP67 T 101 °C Ex mb II T4		Ex tD A20/21 IP67 T 101 °C	
Operating voltage ( $U_b$ )	10...30 V DC		10...30 V DC	
Output current ( $I_o$ )	2 x 150 mA		2 x 150 mA	
No load current ( $I_o$ )	Typ. 15 mA		Typ. 15 mA	
Frequency of operating cycles max.	50 Hz		50 Hz	
Permitted ambient temperature	-25...+90 °C		-25...+90 °C	
LED display	Yes		Yes	
Protective circuit	Yes		Yes	
Norm	IEC 60947-5-2		IEC 60947-5-2	
Degree of protection IEC 60529*	IP 67*		IP 67*	
Connection	2 m cable, PVC, 4 x 0,5 mm <sup>2</sup>		Connector M 12 x 1	
Housing material	PTFE (FDA 21 CFR 177.1550)		PTFE (FDA 21 CFR 177.1550)	
Active surface	PTFE (FDA 21 CFR 177.1550)		PTFE (FDA 21 CFR 177.1550)	
Lid	PC (FDA 21 CFR 177.1580)		PC (FDA 21 CFR 177.1580)	

\*With sealed potentiometer screw

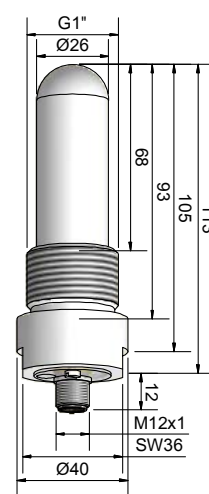
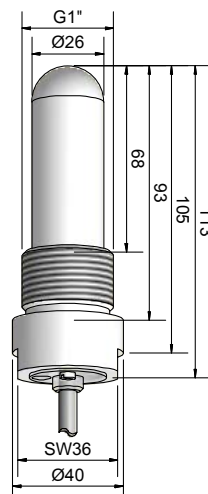
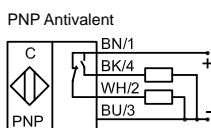
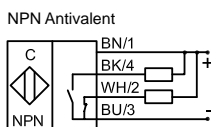

## CAPACITIVE SENSORS Series 26 ATEX StEx

Ø 26 mm



Ø 26 mm



Ø 26 mm



Non-flush mountable		Non-flush mountable		Non-flush mountable	
5 mm		5 mm		5 mm	
0...20 mm		0...20 mm		0...20 mm	
Type description	Art.-No.	Type description	Art.-No.	Type description	Art.-No.
KAS-70-26-A-200-PTFE-1"-StEx-N	-	KAS-70-26-A-PTFE-Tri-StEx-N	KA 1183	KAS-70-26-A-PEEK-1"-HG-Y5-StEx-N	-
KAS-80-26-A-200-PTFE-1"-StEx-N	KA 0444	KAS-80-26-A-PTFE-Tri-StEx-N	KA 0421	KAS-80-26-A-PEEK-1"-HG-Y5-StEx-N	KA 0767
CE, RoHS, UL-CSA		CE, RoHS, UL-CSA		CE, RoHS, UL-CSA	
DMT 01 ATEX E 157		DMT 01 ATEX E 157		DMT 01 ATEX E 157	
Ex II 1/2D IP67 T 101 °C Ex II 2G EEx m II T4		Ex II 1/2D IP67 T 101 °C Ex II 2G EEx m II T4		Ex II 1/2D Ex tD A20/21 IP67 T 101 °C	
IECEX BVS 07.0015		IECEX BVS 07.0015		IECEX BVS 07.0015	
Ex tD A20/21 IP67 T 101 °C Ex mb II T4		Ex tD A20/21 IP67 T 101 °C Ex mb II T4		Ex tD A20/21 IP67 T 101 °C	
10...30 V DC		10...30 V DC		10...30 V DC	
2 x 150 mA		2 x 150 mA		2 x 150 mA	
Typ. 15 mA		Typ. 15 mA		Typ. 15 mA	
50 Hz		50 Hz		50 Hz	
-25...+90 °C		-25...+90 °C		-25...+90 °C	
Yes		Yes		Yes	
Yes		Yes		Yes	
IEC 60947-5-2		IEC 60947-5-2		IEC 60947-5-2	
IP 67**		IP 67*		IP 67*	
2 m cable, PVC, 4 x 0,5 mm <sup>2</sup>		2 m cable, PVC, 4 x 0,5 mm <sup>2</sup>		Connector M 12 x 1	
PTFE (FDA 21 CFR 177.1550)		PTFE (FDA 21 CFR 177.1550)		PEEK (FDA 21 CFR 177.2415)	
PTFE (FDA 21 CFR 177.1550)		PTFE (FDA 21 CFR 177.1550)		PEEK (FDA 21 CFR 177.2415)	
PC (FDA 21 CFR 177.1580)		PC (FDA 21 CFR 177.1580)		PC (FDA 21 CFR 177.1580)	

\*\*IP 68 with use of the protection set, see page 17

Accessories, see page 17

Accessories, see page 18

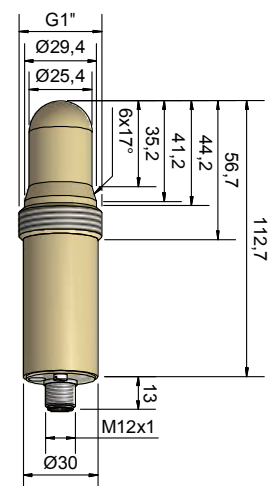
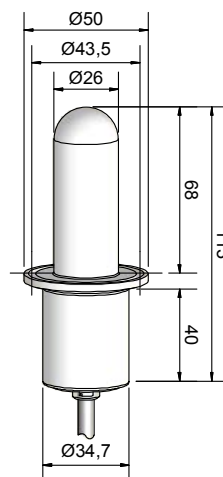
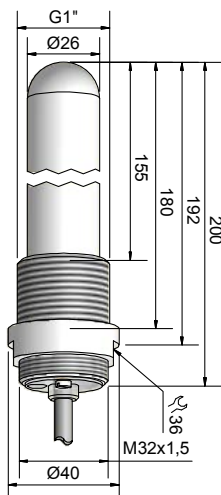

## CAPACITIVE SENSORS AC / DC Series 26

Housing

Ø 26 mm

Ø 26 mm



Technical data	Non-flush mountable		Non-flush mountable	
Sensing distance $S_n$	5 mm		5 mm	
Sensing distance min. / max. adjustable	0...15 mm		0...15 mm	
	Type description	Art.-No.	Type description	Art.-No.
Type AC/DC normally open	KAS-90-26-S-PTFE-1"	KA 0409	KAS-90-26-S-PTFE-1"-Y1	KA 0639
Type AC/DC normally closed	KAS-90-26-Ö-PTFE-1"	KA 0685	KAS-90-26-Ö-PTFE-1"-Y1	KA 1013
Certificate	CE, RoHS		CE, RoHS	
Operating voltage ( $U_o$ )	20...250 V AC / DC		20...250 V AC / DC	
Output current ( $I_o$ )	250 mA		250 mA	
No load current ( $I_o$ )	Typ. 2,5 mA		Typ. 2,5 mA	
Load current min.	5 mA		5 mA	
Frequency of operating cycles max.	25 Hz		25 Hz	
Permitted ambient temperature	-25...+70 °C CIP 121 °C (zero-current)		-25...+70 °C CIP 121 °C (zero-current)	
LED display	Yes		Yes	
Protective circuit	Yes		Yes	
Norm	IEC 60947-5-2		IEC 60947-5-2	
Degree of protection IEC 60529*	IP 67*		IP 67*	
Connection	2 m cable, PUR, 2 x 0,75 mm <sup>2</sup>		Connector M 12 x 1	
Housing material	PTFE (FDA 21 CFR 177.1550)		PTFE (FDA 21 CFR 177.1550)	
Active surface	PTFE (FDA 21 CFR 177.1550)		PTFE (FDA 21 CFR 177.1550)	
Lid	PA / PPO		PA / PPO	

AC - normally open (NO)

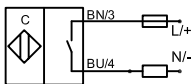

AC - normally closed (NC)

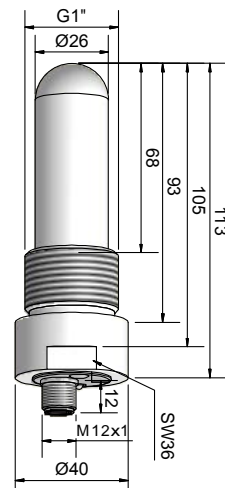
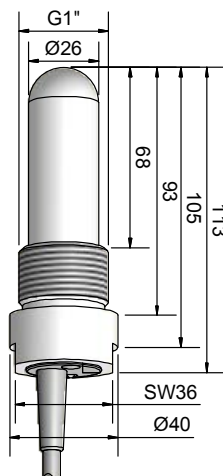
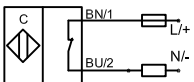

**CAPACITIVE SENSORS AC / DC Series 26**

**Ø 26 mm**

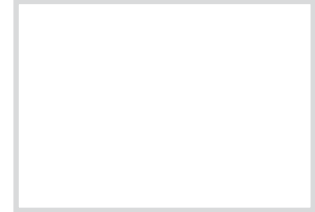
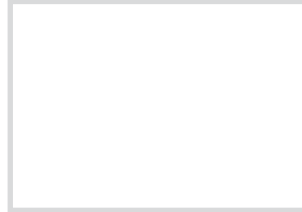

Non-flush mountable			
5 mm			
0...15 mm			
<b>Type description</b>	<b>Art.-No.</b>		
<b>KAS-90-26-S-PTFE-Tri</b>	<b>KA 0684</b>		
<b>KAS-90-26-Ö-PTFE-Tri</b>	<b>KA 0683</b>		
CE, RoHS			
20...250 V AC / DC			
250 mA			
Typ. 2,5 mA			
5 mA			
25 Hz			
-25...+70 °C CIP 121 °C (zero-current)			
Yes			
Yes			
IEC 60947-5-2			
IP 67*			
2 m cable, PUR, 2 x 0,75 mm <sup>2</sup>			
PTFE (FDA 21 CFR 177.1550)			
PTFE (FDA 21 CFR 177.1550)			
PA / PPO			

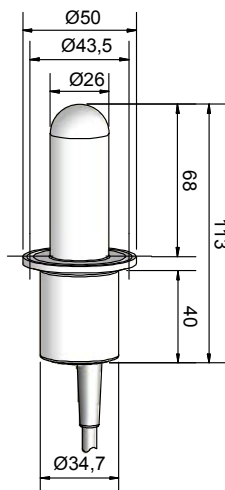

All specifications are subject to change without notice. (11/2011)



## Capacitive Sensors - Series 26 Series 70 - NPN **EasyTeach** Series 80 - PNP



- Housing  $\varnothing = 26 \text{ mm} / 1\frac{1}{2}''$
- Housing material: PP / PBT
- Level sensor with EasyTeach function
- Clear text display
- Suitable for food and pharmaceutical applications  
Plastic part (PP) which will be in contact with the product to be detected is FDA conforme (Code of Federal Regulation, title 21, chapter 1, part 177.1520)
- SIP / CIP 121° C
- Sensor length max. 2000 mm.

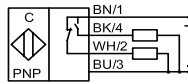
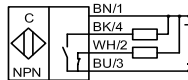

Sensor length „X“ (mm)	Type NPN	Art.-No.	Type PNP	Art.-No.
200	KAS-70-26-A-200-PP-1½ "-PH-ET	KA0781	KAS-80-26-A-200-PP-1½ "-PH-ET	KA0780
280	KAS-70-26-A-280-PP-1½ "-PH-ET	KA0776	KAS-80-26-A-280-PP-1½ "-PH-ET	KA0758
400	KAS-70-26-A-400-PP-1½ "-PH-ET	KA0783	KAS-80-26-A-400-PP-1½ "-PH-ET	KA0782
800	KAS-70-26-A-800-PP-1½ "-PH-ET	KA0785	KAS-80-26-A-800-PP-1½ "-PH-ET	KA0784
1200	KAS-70-26-A-1200-PP-1½ "-PH-ET	KA0787	KAS-80-26-A-1200-PP-1½ "-PH-ET	KA0786

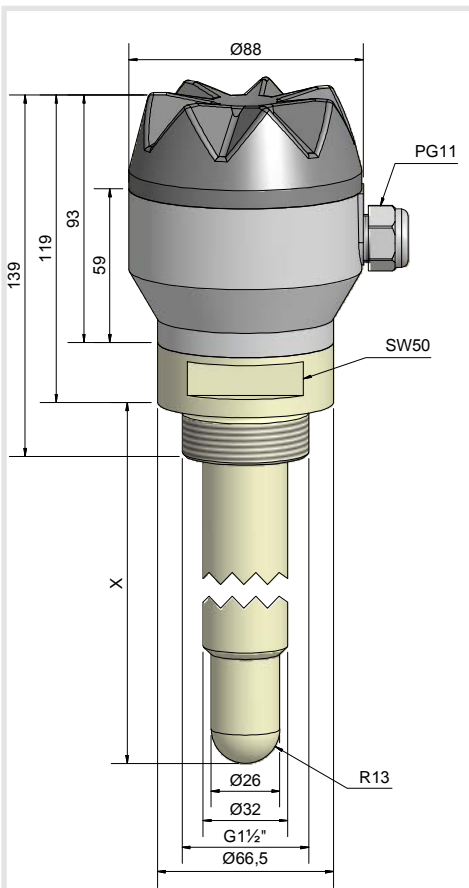

Certificate:		
Technical data	Non-flush mountable	
Operating distance $S_n$	5 mm	
Operating distance min. / max. adjustable	0...20 mm	
Electrical version	4-pin DC	
Output	Antivalent (NO + NC)	
Operating voltage ( $U_b$ )	10...35 V DC	
Output current max. ( $I_o$ )	2 x 250 mA	
Voltage drop max. ( $U_d$ )	≤ 2.0 V	
Permitted residual ripple max.	10%	
No-load current ( $I_o$ )	Typ. 10 mA	
Frequency of operating cycles max.	2 Hz	
Permitted ambient temperature	0...+70° C/ Sensor CIP 121° C (zero-current)	
LCD-display	Reflective	
Protective circuit	Built-in	
Degree of protection IEC 60529 - Sensor	IP 68	
Degree of protection IEC 60529 - Connection head	IP 65	
Norm	EN 60947-5-2	
Connection	Screw terminals 1,5 mm <sup>2</sup>	
Housing material	PP (FDA 21 CFR 177.1520)	
Active surface	PP (FDA 21 CFR 177.1520)	
Connection head	PBT glasfibre reinforced	



## Accessories



**Protection set M30 - Art.-Nr. 196302**  
**M32 - Art.-Nr. 196301**

The PTFE protection set M32 x 1.5 consists of an internally threaded cover, a Pg9-screwing for cable entry and a rubber gasket between the cover and the sensor. This protection cover serves as improvement to the degree of protection, against infiltration of liquids, for example in applications where the sensor is totally immersed in liquids. The resistance of the material still needs to be checked.

The thread of the sensor has to be sealed, for example with PTFE sealing-tape. The protection cover has to be screwed totally up to the end, and then the Pg9-screw has to be fixed.

Protection set, M30 suitable for KAS-70-26-A-M22-M30-PTFE or KAS-80-26-A-M22-M30-PTFE.

M32 suitable for KAS-70-26-A-200-PTFE-1", KAS-80-26-A-200-PTFE-1", KAS-70-26-A-200-PTFE-1"-SiEx-N or KAS-80-26-A-200-PTFE-1"-SiEx-N



**Stainless steel welding nipple DN 25**  
Article No. 190 751

**Sealing gasket**  
Article No. 190 752

**Triclamp mounting clamp**  
Article No. 190 750



Stainless steel welding nipple, suitable for all our capacitive sensors KAS-70- or KAS-80-26-A-PTFE-Tri, KAS-70 or KAS-80-26-A-PTFE-Tri-100°C



**Plastic tube fitting systems**

**PP tube da 32 SDR 11, L = 2000 mm**  
with already welded screw connection on one side  
Article No. 196 360

**PP union nut da 32 / 1 1/2"**  
Article No. 196 361

**O-ring EPDM, suitable for union nut da 32**  
Article No. 196 362



Plastic tube fitting system, suitable for Type KAS-70- or KAS-80-26-A-PTFE-PFS1-Y5



**Plastic tube fitting systems**

**PP / EPDM Screwing da 32 SDR with sealing gasket**  
Article No. 196 363

**PP union nut da 32 / 1 1/2"**  
Article No. 196 361



Plastic tube fitting system, suitable for Type KAS-70- or KAS-80-26-A-PTFE-PFS2

## WELDED SOCKET G 1/2"

For container



Type	Art.-No.
BP 15	196388

## WELDED SOCKET G 1"

For container and tubes



Type	Art.-No.
AP 35	196368



Type	Art.-No.
BP 35	196369

## MILK TUBE FITTING ACCORDING TO DIN 11851 G 1"

Cone nut



Type	Art.-No.
FP 35 - DN 40	196371
GP 35 - DN 50	196372
LP 35 - DN 65	196373

Coupling nut



Type	Art.-No.
FÜ 15 - DN 40	196374
GÜ 15 - DN 50	196375
LÜ 15 - DN 65	196376

Varivent



Type	Art.-No.
HP35 - DN 50 Typ N	196377
IP 35 - DN 25 Typ F	196378

Triclamp



Type	Art.-No.
TP 35	196379

DRD-Flange



Type	Art.-No.
GA 35	196380

## SEALING PLUG G 1"

Sealing plug



Type	Art.-No.
VES35	196381

Welding plug



Type	Art.-No.
ESS35	196382

## TYPE SELECTION IN ARTICLE NUMBER ORDER

Art. No.	Description	Page	Art. No.	Description	Page	Art. No.	Description	Page
190750	Triclamp mounting clamp (Tri)	17	KA...	KAS-70-26-A-300-PTFE-1"-Y5	8	KA0683	KAS-90-26-Ö-PTFE-Tri	15
190751	Welding nipple (Tri)	17	KA...	KAS-70-26-A-M22-M30-PTFE	4	KA0684	KAS-90-26-S-PTFE-Tri	15
190752	Gasket (Tri)	17	KA...	KAS-70-26-A-PEEK-1"-HG-Y5	10	KA0686	KAS-80-26-A-200-PTFE-1"-Y5	7
196301	Sealing set M32	17	KA...	KAS-70-26-A-PEEK-1"-HG-Y5-StEx-N	13	KA0687	KAS-80-26-A-200-PTFE-100°C-Y5	8
196302	Sealing set M30	17	KA...	KAS-70-26-A-PTFE-1"-100°C	6	KA0688	KAS-80-26-A-PTFE-1"-100°C-Y5	6
196360	PP Tube L = 2 m (PFS1)	17	KA...	KAS-70-26-A-PTFE-1"-100°C-Y5	6	KA0689	KAS-80-26-PTFE-M30-Y5	5
196361	PP Union nut (PFS1 + PFS2)	17	KA...	KAS-70-26-A-PTFE-1"-CIP160	7	KA0740	KAS-40-26-N-PTFE-1"	11
196362	O-Ring EFDm (PFS1 + PFS2)	17	KA...	KAS-70-26-A-PTFE-1"-Y5-StEx-N	12	KA0758	KAS-80-280-PP-1½"-PH-ET	16
196363	PP Screwing D = 32 (PFS2)	17	KA...	KAS-70-26-A-PTFE-PFS1-Y5	10	KA0764	KAS-80-26-A-PEEK-1"-HG-Y5	10
196368	AP 35	18	KA...	KAS-70-26-A-PTFE-M30-Y5	5	KA0767	KAS-80-26-A-PEEK-1"-HG-Y5-StEx-N	13
196369	BP 35	18	KA...	KAS-70-26-A-PTFE-Tri-100°C-Y5	9	KA0776	KAS-70-26-A-280-PP-1½"-PH-ET	16
196371	FP 35 - DN 40	18	KA...	KAS-70-26-A-PTFE-PFS2	9	KA0780	KAS-80-26-A-200-PP-1½"-PH-ET	16
196372	GP 35 - DN 50	18	KA0264	KAS-80-26-A-PTFE-1"-StEx-N	12	KA0781	KAS-70-26-A-200-PP-1½"-PH-ET	16
196373	LP 35 - DN 65	18	KA0277	KAS-80-26-A-PTFE-1"-100°C	6	KA0782	KAS-80-26-A-400-PP-1½"-PH-ET	16
196374	FÜ 15 - DN 40	18	KA0409	KAS-80-26-S-PTFE-1"	14	KA0783	KAS-70-26-A-400-PP-1½"-PH-ET	16
196375	GÜ 15 - DN 50	18	KA0415	KAS-80-26-A-PTFE-Tri-StEx-N	13	KA0784	KAS-80-26-A-800-PP-1½"-PH-ET	16
196376	LÜ 15 - DN 65	18	KA0415	KAS-80-26-A-PTFE-Tri-100°C	9	KA0785	KAS-70-26-A-800-PP-1½"-PH-ET	16
196377	HP 35 - DN 50 Typ N, Varivent	18	KA0431	KAS-80-26-A-M22-M30-PTFE	4	KA0786	KAS-80-26-A-1200-PP-1½"-PH-ET	16
196378	IP 35 - DN 25 Typ N, Varivent	18	KA0444	KAS-80-26-A-200-PTFE-1"-StEx-N	13	KA0787	KAS-70-26-A-1200-PP-1½"-PH-ET	16
196379	TP 35, Triclamp	18	KA0450	KAS-80-26/22-A-PTFE-100°C-Y5	4	KA0824	KAS-80-26-A-PTFE-Tri-StEx-N	12
196380	GA 35	18	KA0549	KAS-80-26-A-PTFE-PFS1-Y5	10	KA0844	KAS-70-26-A-PTFE-1"-Y5	5
196381	VES 35	18	KA0566	KAS-80-26-A-PTFE-PFS2	9	KA1013	KAS-90-26-Ö-PTFE-1"-Y1	14
196382	ESS 35	18	KA0639	KAS-90-26-S-PTFE-1"-Y1	14	KA1025	KAS-70-26-A-PTFE-Tri-100°C	9
196388	BP 15	18	KA0642	KAS-80-26-A-PTFE-1"-Y5	5	KA1078	KAS-70-26-A-PTFE-1"	5
813100	KAS-80-26-A-PTFE-1"	5	KA0647	KAS-80-26-A-PTFE-1"-CIP160	7	KA1183	KAS-70-26-A-PTFE-Tri-StEx-N	13
KA...	KAS-70-26/22-A-PTFE-100°C-Y5	4	KA0653	KAS-80-26-A-200-PTFE-1"	7			
KA...	KAS-70-26-A-200-PTFE-1"	7	KA0655	KAS-80-26-A-PTFE-1"-Y5-StEx-N	12			
KA...	KAS-70-26-A-200-PTFE-1"-StEx-N	13	KA0658	KAS-90-26-Ö-PTFE-1"	14			
KA...	KAS-70-26-A-200-PTFE-1"-Y5	7	KA0662	KAS-80-26-A-PTFE-Tri-100°C-Y5	9			
KA...	KAS-70-26-A-200-PTFE-1"-100°C-Y5	8	KA0682	KAS-80-26-A-300-PTFE-1"-Y5	8			

## TYPE SELECTION IN DESCRIPTION ORDER

Art. No.	Description	Page	Art. No.	Description	Page	Art. No.	Description	Page
196368	AP 35	18	KA...	KAS-70-26-A-PTFE-1"-CIP160	7	KA0655	KAS-80-26-A-PTFE-1"-Y5-StEx-N	12
196388	BP 15	18	KA0824	KAS-70-26-A-PTFE-1"-StEx-N	12	KA0549	KAS-80-26-A-PTFE-PFS1-Y5	10
196369	BP 35	18	KA0844	KAS-70-26-A-PTFE-1"-Y5	5	KA0566	KAS-80-26-A-PTFE-PFS2	9
196382	ESS 35	18	KA...	KAS-70-26-A-PTFE-1"-Y5-StEx-N	12	KA0415	KAS-80-26-A-PTFE-Tri-100°C	9
196371	FP 35 - DN 40	18	KA...	KAS-70-26-A-PTFE-PFS1-Y5	10	KA0662	KAS-80-26-A-PTFE-Tri-100°C-Y5	9
196374	FÜ 15 - DN 40	18	KA...	KAS-70-26-A-PTFE-PFS2	9	KA0421	KAS-80-26-A-PTFE-Tri-StEx-N	13
196380	GA 35	18	KA1025	KAS-70-26-A-PTFE-Tri-100°C	9	KA0689	KAS-80-26-PTFE-M30-Y5	5
196372	GP 35 - DN 50	18	KA...	KAS-70-26-A-PTFE-Tri-100°C-Y5	9	KA0658	KAS-90-26-Ö-PTFE-1"	14
196375	GÜ 15 - DN 50	18	KA1183	KAS-70-26-A-PTFE-Tri-StEx-N	13	KA1013	KAS-90-26-Ö-PTFE-1"-Y1	14
196377	HP 35 - DN 50 Type N, Varivent	18	KA...	KAS-70-26-A-PTFE-M30-Y5	5	KA0683	KAS-90-26-Ö-PTFE-Tri	15
196378	IP 35 - DN 25 Type N, Varivent	18	KA0450	KAS-80-26/22-A-PTFE-100°C-Y5	4	KA0409	KAS-90-26-S-PTFE-1"	14
190752	Gasket (Tri)	17	KA0786	KAS-80-26-A-1200-PP-1½"-PH-ET	16	KA0639	KAS-80-26-S-PTFE-1"-Y1	14
KA0740	KAS-40-26-N-PTFE-1"	11	KA0780	KAS-80-26-A-200-PP-1½"-PH-ET	16	KA0684	KAS-90-26-S-PTFE-Tri	15
KA...	KAS-70-26/22-A-PTFE-100°C-Y5	4	KA0653	KAS-80-26-A-200-PTFE-1"	7	196373	LP 35 - DN 65	18
KA0787	KAS-70-26-A-1200-PP-1½"-PH-ET	16	KA0687	KAS-80-26-A-200-PTFE-1"-100°C-Y5	8	196376	LÜ 15 - DN 65	18
KA0781	KAS-70-26-A-200-PP-1½"-PH-ET	16	KA0444	KAS-80-26-A-200-PTFE-1"-StEx-N	13	196362	O-Ring EFDm (PFS1 + PFS2)	17
KA...	KAS-70-26-A-200-PTFE-1"	7	KA0686	KAS-80-26-A-200-PTFE-1"-Y5	7	196360	PP Rohr L = 2 m (PFS1)	17
KA...	KAS-70-26-A-200-PTFE-1"-100°C-Y5	8	KA0758	KAS-80-26-A-280-PP-1½"-PH-ET	16	196361	PP union nut (PFS1 + PFS2)	17
KA...	KAS-70-26-A-200-PTFE-1"-StEx-N	13	KA0682	KAS-80-26-A-300-PTFE-1"-Y5	8	196363	PP screwing D = 32 (PFS2)	17
KA...	KAS-70-26-A-200-PTFE-1"-Y5	7	KA0782	KAS-80-26-A-400-PP-1½"-PH-ET	16	196302	Sealing Set M30	17
KA0776	KAS-70-26-A-280-PP-1½"-PH-ET	16	KA0784	KAS-80-26-A-800-PP-1½"-PH-ET	16	196301	Sealing Set M32	17
KA...	KAS-70-26-A-300-PTFE-1"-Y5	8	KA0431	KAS-80-26-A-M22-M30-PTFE	4	196379	TP 35, Triclamp	18
KA0783	KAS-70-26-A-400-PP-1½"-PH-ET	16	KA0764	KAS-80-26-A-PEEK-1"-HG-Y5	10	190750	Triclamp mounting clamp (Tri)	17
KA0785	KAS-70-26-A-800-PP-1½"-PH-ET	16	KA0767	KAS-80-26-A-PEEK-1"-HG-Y5-StEx-N	13	196381	VES 35	18
KA...	KAS-70-26-A-M22-M30-PTFE	4	813100	KAS-80-26-A-PTFE-1"	5	190751	Welding nipple (Tri)	17
KA...	KAS-70-26-A-PEEK-1"-HG-Y5	10	KA0277	KAS-80-26-A-PTFE-1"-100°C	6			
KA...	KAS-70-26-A-PEEK-1"-HG-Y5-StEx-N	13	KA0688	KAS-80-26-A-PTFE-1"-100°C-Y5	6			
KA1078	KAS-70-26-A-PTFE-1"	5	KA0647	KAS-80-26-A-PTFE-1"-CIP160	7			
KA...	KAS-70-26-A-PTFE-1"-100°C	6	KA0264	KAS-80-26-A-PTFE-1"-StEx-N	12			
KA...	KAS-70-26-A-PTFE-1"-100°C-Y5	6	KA0642	KAS-80-26-A-PTFE-1"-Y5	5			

All specifications are subject to change without notice. (11/2011)

# SENSORS FOR INDUSTRIAL AUTOMATION

**ASK FOR FURTHER CATALOGUES:  
CAPACITIVE SENSORS KAS  
CAPACITIVE SENSORS KXS  
CAPACITIVE LEVEL MEASURING SYSTEMS  
INDUCTIVE SENSORS IAS  
MAGNETO RESISTIVE SENSORS  
OPTOELECTRONIC SENSORS  
FLOW SENSORS  
CONDUCTIVITY SENSORS  
ATEX CERTIFIED PRODUCTS  
POWER SUPPLIES AND EX BARRIERS**

**YOUR REPRESENTATIVE**

# RECHNER

INDUSTRIE-ELEKTRONIK GmbH

**Gaußstraße 8-10 • 68623 Lampertheim • Germany**

Tel. (0 62 06) 50 07-0 Fax (0 62 06) 50 07-36 Fax Intl. +49 (0) 62 06 50 07-20 www.rechner-sensors.com e-mail: info@rechner-sensors.de

## CANADA

**Rechner Automation Inc**  
348 Bronte St. South - Unit 11  
Milton, ON L9T 5B6

Tel. 9056360866  
Fax. 9056360867  
contact@rechner.com  
www.rechner.com

## GREAT BRITAIN

**Rechner (UK) Limited**  
Unit 6, The Old Mill  
61 Reading Road  
Pangbourne, Berks, RG8 7HY

Tel. +44 118 976 6450  
Fax. +44 118 976 6451  
info@rechner-sensors.co.uk  
www.rechner-sensors.co.uk

## PEOPLE'S REPUBLIC OF CHINA

**RECHNER SENSORS SIP CO.LTD.**  
Building H,  
No. 58, Yang Dong Road  
Suzhou Industrial Park  
Jiangsu Province

Tel. +8651267242858  
Fax. +8651267242868  
assist@rechner-sensor.cn  
www.rechner-sensor.cn

## REPUBLIC OF KOREA (SOUTH)

**Rechner-Korea Co. Ltd.**  
A-1408 Ho,  
Keungang Penterium IT Tower,  
Hakeuro 282, Dongan-gu  
Anyang City, Gyunggi-do, Seoul

Tel. +82 31 422 8331  
Fax. +82 31 423 83371  
sensor@rechner.co.kr  
www.rechner.co.kr

## UNITED STATES OF AMERICA

**Rechner Electronics Ind. Inc.**  
6311 Inducon Corporate Drive,  
Suite 5  
Sanborn, NY. 14132

Tel. 8005444106  
Fax. 9056360867  
contact@rechner.com  
www.rechner.com