

# Proximity Inductive Sensors Standard Range, Nickel-Plated Brass Housing Types ICB, M30

CARLO GAVAZZI



- Sensing distance: 10 to 15 mm
- Flush or non-flush types
- Short or long body versions
- Rated operational voltage ( $U_b$ ): 10 - 36 VDC
- Output: DC 200 mA, NPN or PNP
- Normally open or Normally closed
- LED indication for output ON
- Protection: reverse polarity, short circuit, transients
- Cable or M12 plug versions
- According to IEC 60947-5-2
- CSA certified for Hazardous Locations



## Product Description

A family of inductive proximity switches in industrial standard nickel-plated brass housings. They are able to handle applications where high sensing range is requested.

Output is open collector NPN or PNP transistors.

## Ordering Key

**ICB30SF10NOM1**

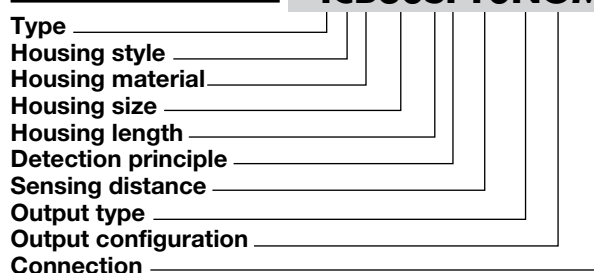

## Type Selection

Conne- ction	Body style	Rated operating distance $S_n$	Ordering no. NPN, Normally open	Ordering no. PNP, Normally open	Ordering no. NPN, Normally closed	Ordering no. PNP, Normally closed
Cable	Short	10 mm <sup>1)</sup>	ICB30SF10NO	ICB30SF10PO	ICB30SF10NC	ICB30SF10PC
Cable	Short	15 mm <sup>2)</sup>	ICB30SN15NO	ICB30SN15PO	ICB30SN15NC	ICB30SN15PC
Plug	Short	10 mm <sup>1)</sup>	ICB30SF10NOM1	ICB30SF10POM1	ICB30SF10NCM1	ICB30SF10PCM1
Plug	Short	15 mm <sup>2)</sup>	ICB30SN15NOM1	ICB30SN15POM1	ICB30SN15NCM1	ICB30SN15PCM1
Cable	Long	10 mm <sup>1)</sup>	ICB30LF10NO	ICB30LF10PO	ICB30LF10NC	ICB30LF10PC
Cable	Long	15 mm <sup>2)</sup>	ICB30LN15NO	ICB30LN15PO	ICB30LN15NC	ICB30LN15PC
Plug	Long	10 mm <sup>1)</sup>	ICB30LF10NOM1	ICB30LF10POM1	ICB30LF10NCM1	ICB30LF10PCM1
Plug	Long	15 mm <sup>2)</sup>	ICB30LN15NOM1	ICB30LN15POM1	ICB30LN15NCM1	ICB30LN15PCM1

<sup>1)</sup> For flush mounting in metal

<sup>2)</sup> For non-flush mounting in metal

## Specifications

<b>Rated operational voltage (<math>U_b</math>)</b>	10 to 36 VDC (ripple incl.)	<b>Indication for short circuit/ overload</b>	LED blinking (f = 2 Hz)
<b>Ripple</b>	≤ 10%	<b>Assured operating sensing distance (<math>S_a</math>)</b>	$0 \leq S_a \leq 0.81 \times S_n$
<b>Output current (<math>I_o</math>)</b>	≤ 200 mA @ 50°C (≤ 150 mA @ 50-70°C)	<b>Effective operating distance (<math>S_r</math>)</b>	$0.9 \times S_n \leq S_r \leq 1.1 \times S_n$
<b>OFF-state current (<math>I_i</math>)</b>	≤ 50 μA	<b>Usable operating distance (<math>S_u</math>)</b>	$0.85 \times S_r \leq S_u \leq 1.1 \times S_r$
<b>No load supply current (<math>I_o</math>)</b>	≤ 15 mA	<b>Repeat accuracy (R)</b>	≤ 5%
<b>Voltage drop (<math>U_d</math>)</b>	Max. 2.5 VDC @ 200 mA	<b>Differential travel (H) (Hysteresis)</b>	1 to 20% of sensing dist.
<b>Protection</b>	Reverse polarity, short-circuit, transients	<b>Ambient temperature</b>	Operating -25° to +70°C (-13° to +158°F) Storage -30° to +80°C (-22° to +176°F)
<b>Voltage transient</b>	1 kV/0.5 J	<b>Shock and vibration</b>	IEC 60947-5-2/7.4
<b>Power ON delay (<math>t_v</math>)</b>	300 ms	<b>Housing material</b>	Body Nickel-plated brass Front cap Grey thermoplastic polyester
<b>Operating frequency (f)</b>	≤ 1000 Hz		
<b>Indication for output ON</b>	Activated LED, yellow		
NO version	Target present		
NC version	Target not present		

## Specifications (cont.)

<b>Connection</b> Cable	Ø5.2 x 2 m, 3 x 0.34 mm <sup>2</sup> , grey PVC, oil proof M12 x 1
Plug	
<b>Degree of protection</b>	IP 67
<b>Weight</b> (cable/nuts included) ICB30 S ICB30 L	Max. 185 g Max. 195 g
<b>Dimensions</b>	See diagrams below
<b>Tightening torque</b>	25 Nm
<b>Approvals</b> <b>UL (RU), CSA</b>	As Industrial Control Equipment - Proximity Switches. Types 1, 4, 4X or 12. Max ambient temperature 40°C.

### Approvals (cont.)

#### cCSAus

Note: The terminal connector (version ...M1) was not evaluated. The suitability of the terminal connector should be determined in the end-use application.

As Process Control Equipment for Hazardous Locations.

- Class I, Division 2,  
Groups A, B, C and D.  
- T5, Enclosure Type 4.  
Ambient temperature  
Ta: -25° to +60°C.

CCC is not required for products with a maximum operating voltage of ≤ 36 V

### EMC protection

IEC 61000-4-2 (ESD)

IEC 61000-4-3  
IEC 61000-4-4  
IEC 61000-4-6  
IEC 61000-4-8

According to IEC 60947-5-2  
8 kV air discharge,  
4 kV contact discharge  
3 V/m  
2 kV  
3 V  
30 A/m

## Dimensions (mm)

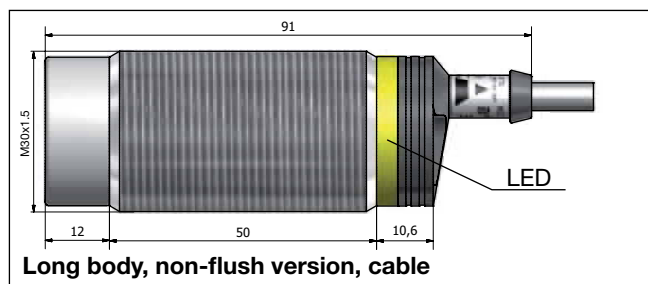
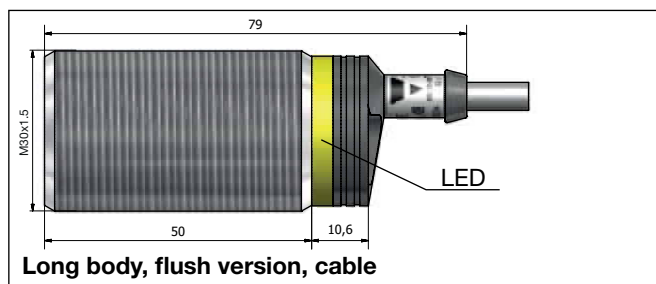
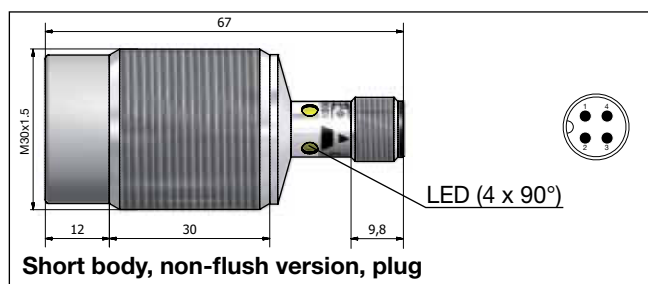
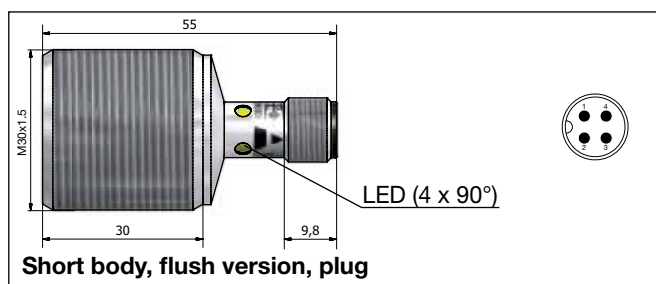
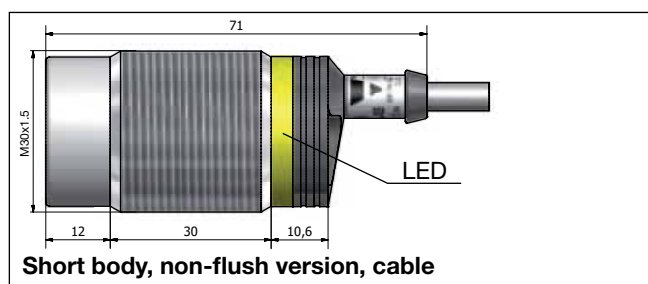
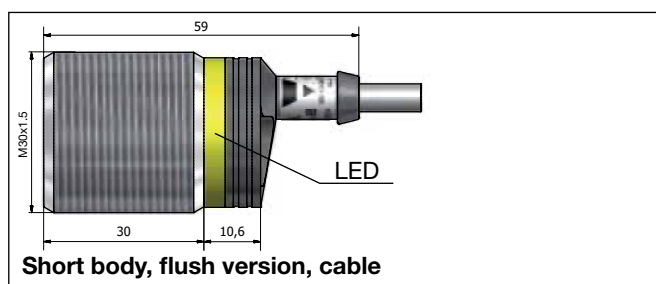

## Dimensions (mm) (cont.)

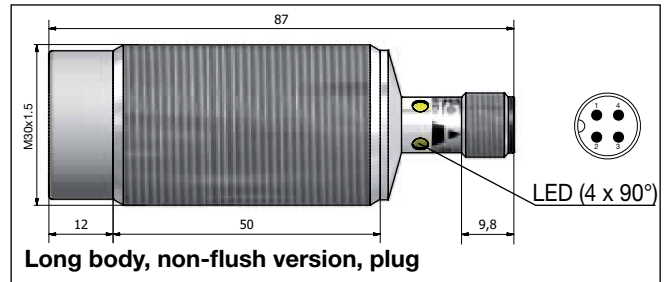
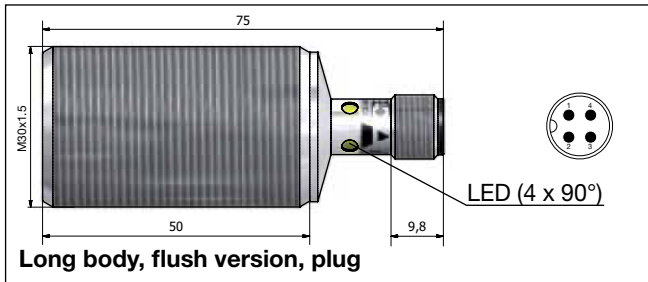

## Installation

Flush sensor, when installed in damping material, must be according to Picture 1A.

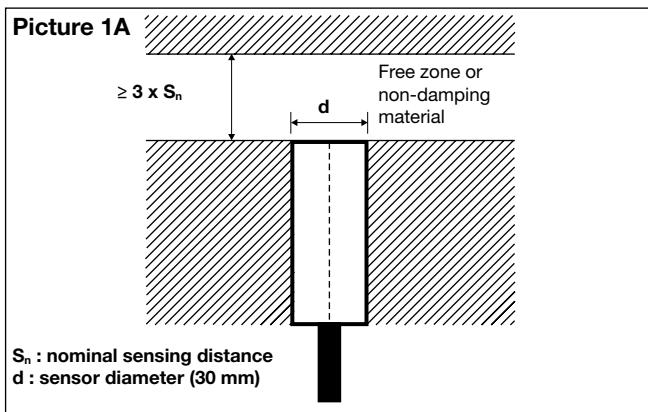

Non-flush sensor, when installed in damping material, must be according to Picture 1B.

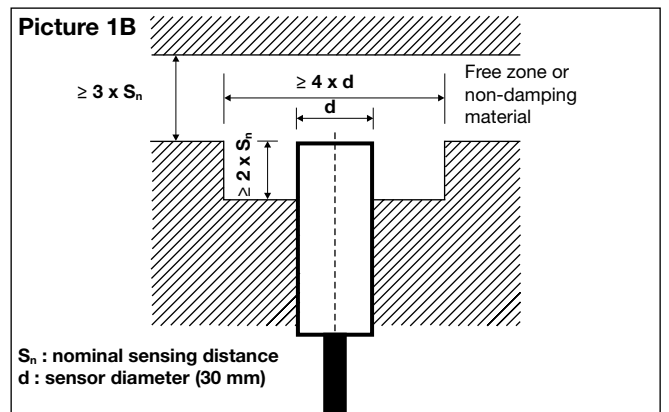

Flush sensors, when installed together in damping material, must be according to Picture 2A.

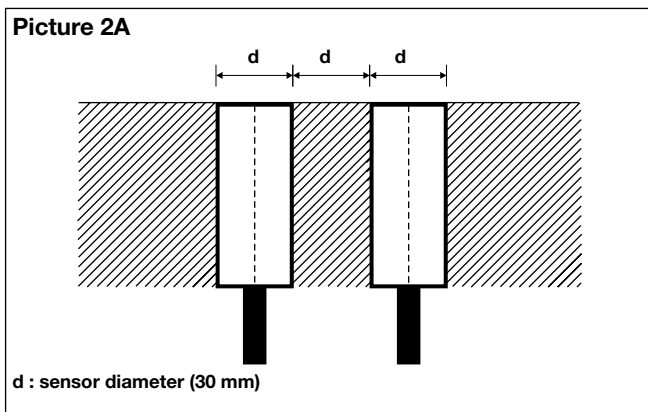

Non-flush sensors, when installed together in damping material, must be according to Picture 2B.

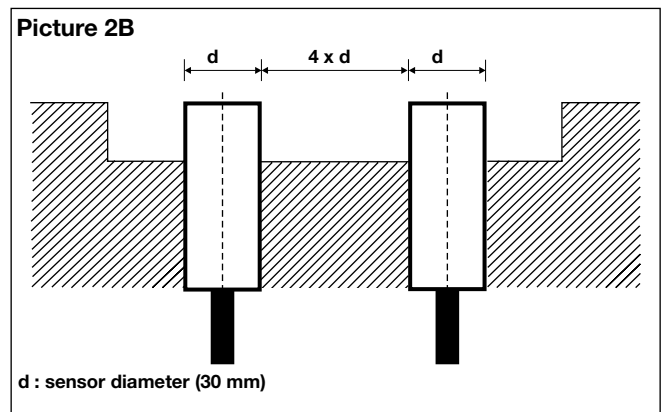

For sensors installed opposite each other, a minimum space of  $6 \times S_n$  (the nominal sensing distance) must be observed (See Picture 3).

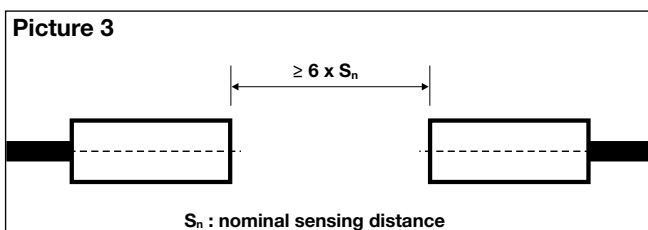



## Wiring Diagram

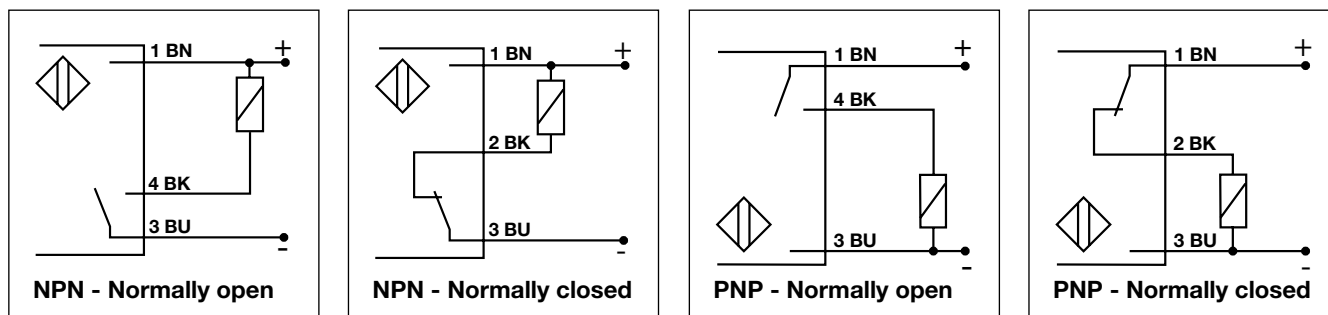

## Reduction Factors

The rated operating distance is reduced by the use of metals and alloys other than Fe360.

The most important reduction factors for inductive proximity sensors are shown in Picture 4.

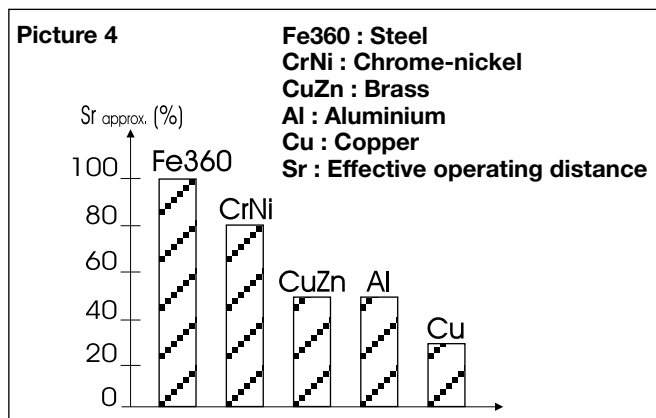

## Accessories for Plug Versions

3-wire angled connector, 2 m cable	<b>CONM13NF-A2</b>
3-wire angled connector, 5 m cable	<b>CONM13NF-A5</b>
3-wire angled connector, 10 m cable	<b>CONM13NF-A10</b>
3-wire straight connector, 2 m cable	<b>CONM13NF-S2</b>
3-wire straight connector, 5 m cable	<b>CONM13NF-S5</b>

**For any additional information or different options, please refer to the "General Accessories" datasheets.**

## Delivery Contents

- Inductive proximity switch ICB.
- 2 nuts NPB
- Packaging: plastic bag