

**SG2-PRESENCE CONTROL SERIES**

The **SAFEasy™ SG2** light curtains represent the natural evolution of the SF2 series.

The **SG2** series offers two models, **SG2-B “Base”** and **SG2-E “Extended”**, thus guaranteeing compatibility with the SF2 series (**SG2-B**), as well as offering advanced functions for a Type 2 safety light curtain, such as EDM and Anti-Interference (**SG2-E**). Models with controlled heights ranging from 300 to 1800 mm are available, all with an operating distance reaching 19 m. The response times ranging from 9 to 20 msec result to be amongst the lowest on the market, consenting the installation of the product nearer to the dangerous area. As well as offering the base functions present in the **SG2-B** model, the **SG2-E** series integrates advanced functions for a Type 2 device such as manual/automatic Restart, EDM function, Anti-interference system (obtained thanks to the reduction to 9 m of the maximum operating distance). All selectable functions.

The profile and rotating fixing brackets ease installation and the alignment of the emitting and receiving units, even at long distances and in applications with deviating mirrors.

The **SG2** series represents the ideal solution for all the typical applications of a Type 2 safety light curtain.



**HIGHLIGHTS**

- Integrated light curtain for PRESENCE CONTROL
- Maximum operating distance reaching 19 m
- Controlled heights ranging from 300 to 1800mm
- New sturdy profile and rotating brackets
- Selectable Manual/Automatic Restart, EDM and Anti-Interference

**APPLICATIONS**

- Automatic machines;
- Packaging, material handling and storage machines;
- Textile, wood-working and ceramic machines;
- Automatic and semi-automatic assembling lines;
- Automatic warehouses.



The characteristics introduced by the SG2 safety light curtains are:

- Operating distance reaching 19 m
- Wider controlled height range (reaching 1800 mm)
- Reduced response times, 30% less than SF2
- New sturdy and more functional profile
- Easier and quicker installation thanks to the new rotating fixing brackets that ease alignment even in the harshest conditions
- Compatibility with the entire SE accessory range
- SG2-E with selectable functions, such as Manual/Automatic Restart, EDM and Anti-Interference thanks to the reduction of the maximum operating distance from 19 to 9 m

## DIMENSIONS

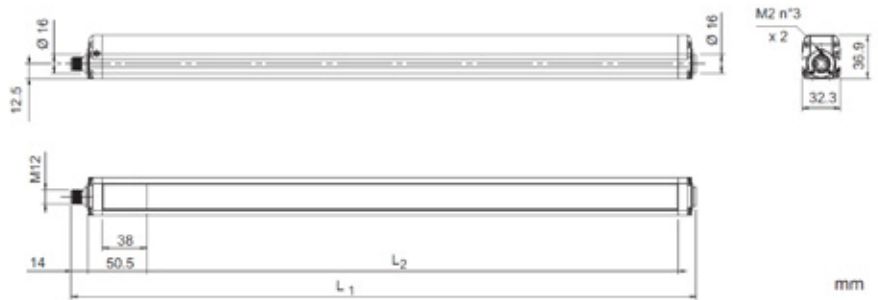

VERSION	L <sub>1</sub>	L <sub>2</sub>
SG2-kk-030-OO-*	383.2	303.2
SG2-kk-045-OO-*	533.2	453.3
SG2-kk-060-OO-*	683.2	603.2
SG2-kk-075-OO-*	833.2	753.3
SG2-kk-090-OO-*	983.2	903.2
SG2-kk-105-OO-*	1133.2	1053.2
SG2-kk-120-OO-*	1283.3	1203.3
SG2-kk-135-OO-*	1433.2	1353.2
SG2-kk-150-OO-*	1583.3	1503.3
SG2-kk-165-OO-*	1733.3	1653.3
SG2-kk-180-OO-*	1883.3	1803.3

kk = Resolution (50 mm – 90 mm)  
 \* = X Base model or E-C Extended model

## INDICATORS AND SETTINGS



### SG2-B

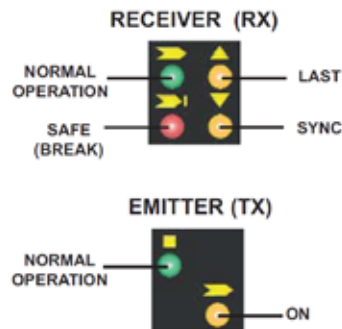

### SG2-E RECEIVER (RX)

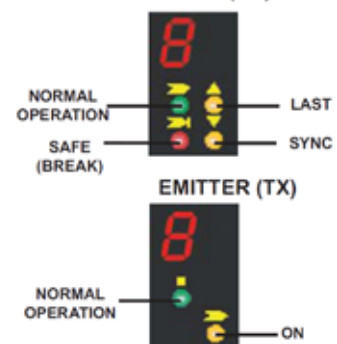

## CONNECTIONS

### SG2-B

RX: M12 5-POLE CONNECTOR

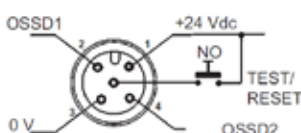

- 1 = brown = +24 Vdc
- 2 = white = OSSD1
- 3 = blue = 0 V
- 4 = black = OSSD2
- 5 = grey = TEST/RESET

TX: M12 4-POLE CONNECTOR

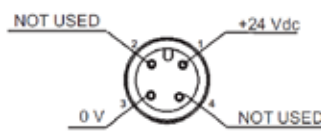

- 1 = brown = +24 Vdc
- 2 = white = NOT USED
- 3 = blue = 0 V
- 4 = black = NOT USED

### SG2-E

RX: M12 8-POLE CONNECTOR

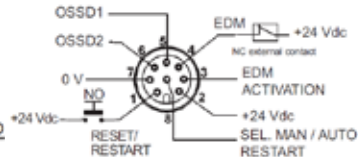

- 1 = white = RESET (\*)
- 2 = brown = +24 Vdc
- 3 = green = EDM ACTIVATION
- 4 = yellow = EDM
- 5 = grey = OSSD1
- 6 = pink = OSSD2
- 7 = blue = 0 V
- 8 = red = SEL. MAN. / AUTO RESTART

TX: M12 4-POLE CONNECTOR

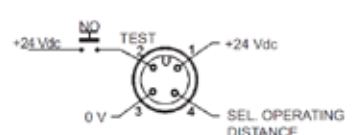

- 1 = brown = +24 Vdc
- 2 = white = TEST
- 3 = blue = 0 V
- 4 = black = SEL. OPERATING DISTANCE

**NOTE:** For MANUAL RESTART CONNECT TOGETHER Pin8 with Pin6.  
 For Automatic Restart connect together Pin8 with Pin5

**SG2-E: FUNCTIONS**

**EDM**

The **EDM** function allows to connect the light barrier to a couple of simple forced-guided safety relays instead to a Type 2 safety relay and thus guaranteeing an enormous economical advantage.

**Connection with EDM function**

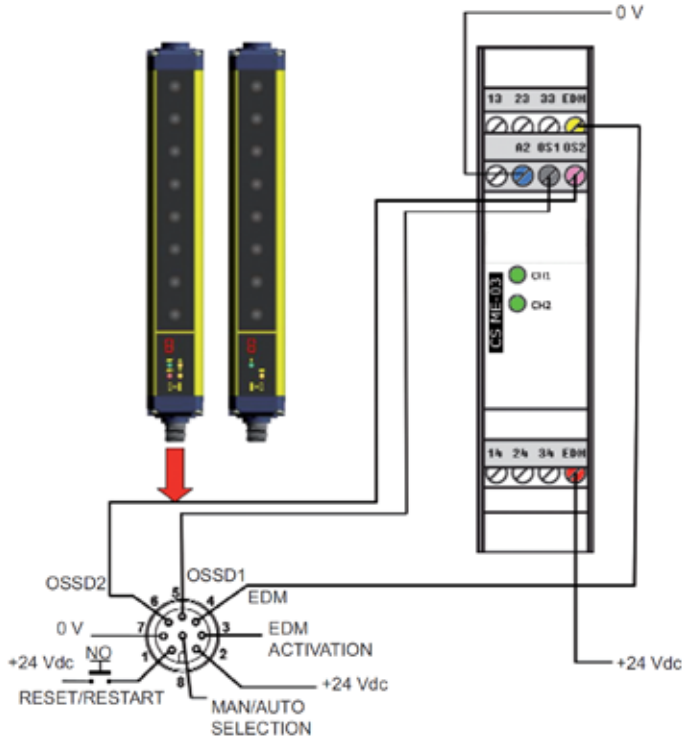

**Connection without EDM function**

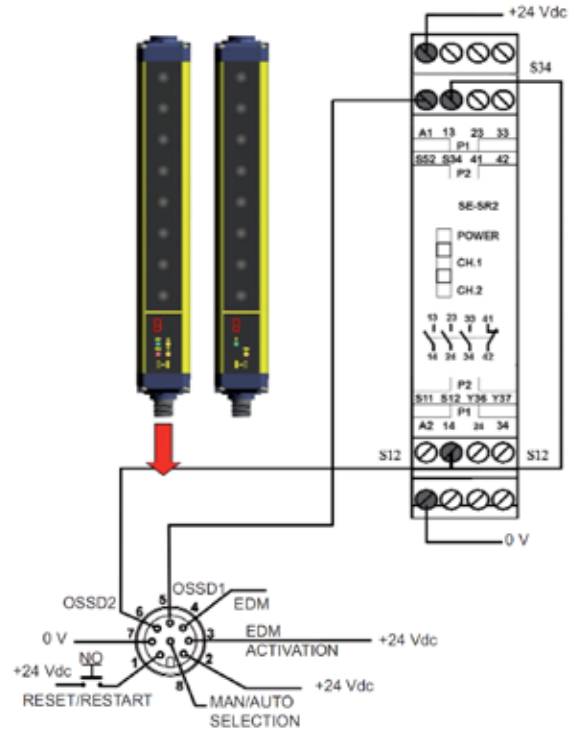

**Anti-Interference system**

The Anti-Interference system consents the installation of different light curtains aligned one next to the other avoiding mutual optical interference, without the need to install separating shields.

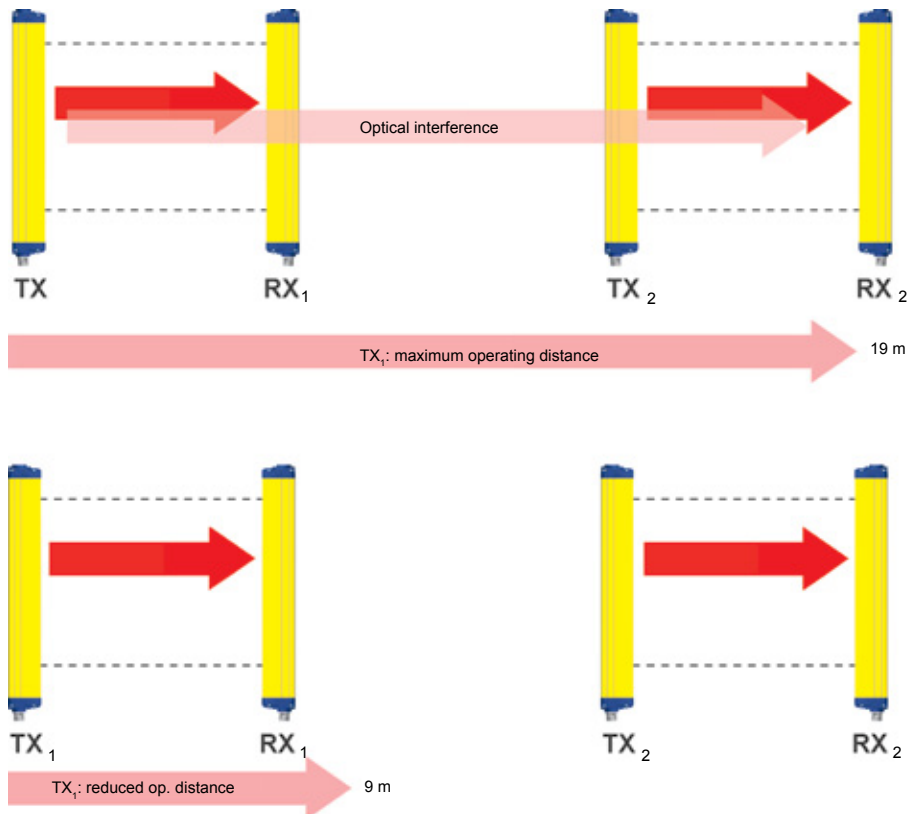

## TECHNICAL DATA

Electrical Data	
Power supply (Vdd):	24 Vdc ± 20%
Consumption (emitter):	2 W max
Consumption (receiver):	3.5 W max (without load)
OSSD outputs:	2 PNP
Short-circuit protection:	1.4 A max
Output current:	0.5 A max on each output
Output voltage - ON status:	Vdd -1 V min
Output voltage - OFF status:	0.2 V max
Capacitive load:	2.2 uF @ 24 Vdc max
Response time:	Refer to table
Controlled height:	300..1800 mm
Safety category:	Type 2
Auxiliary functions:	
SG2-B	Reset / Test
	Automatic Restart
SG2-E	Reset / Test
	Man./Auto Restart
	Selectable EDM
Electrical protection:	Class I / Class III
Connections:	
SG2-B	M12 4-pole for emitter
	M12 5-pole for receiver
SG2-E	M12 4-pole for emitter
	M12 8-pole for receiver
Cable length (for powering):	50 m max *
OPTICAL DATA	
Light emission:	Infrared LED (950 nm)
Resolution:	50 - 90 mm
Operating distance:	0.2...19 m (SG2-B)
	selectable 0.2...9 m / 0.2...19 m (SG2-E)
Aperture angle (EAA) :	± 5°
Ambient light rejection:	IEC-61496-2
MECHANICAL AND ENVIRONMENTAL DATA	
Operating temperature:	
SG-B	0 - + 55 °C
SG-E	-10...+55 °C
Storage temperature:	- 25...+ 70 °C
Temperature class:	T6
Humidity:	15...95 % (non condensating)
Mechanical protection:	IP 65 (EN 60529)
Vibrations:	0.35 mm amplitude
	10 ... 55 Hz frequency, 20 sweep per axis
	1 octave/min (EN 60068-2-6)
Shock resistance:	16 ms (10 G) 1.000 shock per axis
	(EN 60068-2-29)
Housing material:	Painted aluminium (yellow RAL 1003)
Protective shield materiale:	PMMA
Cap material:	PC MAKROLON
Weight:	1 kg / m

\*If a longer cable has to be used, please verify that the capacitive load specifications are respected

## TABLES

MODEL	50 mm	90 mm
SG2 height 300	9	5
SG2 height 450	13	7
SG2 height 600	17	9
SG2 height 750	21	11
SG2 height 900	25	13
SG2 height 1050	29	15
SG2 height 1200	33	17
SG2 height 1350	37	19
SG2 height 1500	41	21
SG2 height 1650	45	23
SG2 height 1800	49	25

Table 1: NUMBER OF CONTROLLED BEAMS

MODEL	
SG2 height 300	300
SG2 height 450	450
SG2 height 600	600
SG2 height 750	750
SG2 height 900	900
SG2 height 1050	1050
SG2 height 1200	1200
SG2 height 1350	1350
SG2 height 1500	1500
SG2 height 1650	1650
SG2 height 1800	1800

Table 2: CONTROLLED HEIGHT (mm)

MODEL	50 mm	90 mm
SG2 height 300	9	9
SG2 height 450	10	10
SG2 height 600	11	11
SG2 height 750	12	12
SG2 height 900	14	13
SG2 height 1050	15	14
SG2 height 1200	16	15
SG2 height 1350	17	16
SG2 height 1500	18	17
SG2 height 1650	19	18
SG2 height 1800	20	19

Table 3: RESPONSE TIME (ms)



**FIXING BRACKET**

Rotating fixing bracket<sup>1</sup>

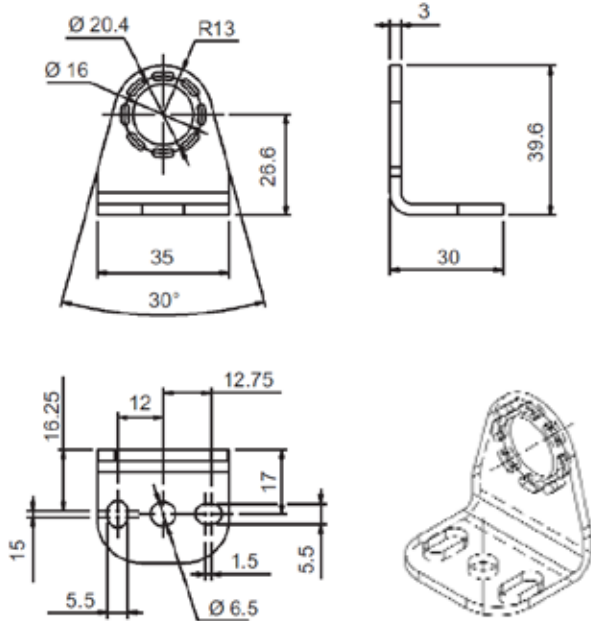

<sup>1</sup> Supplied with the Extended model

Angled fixing bracket<sup>2</sup>

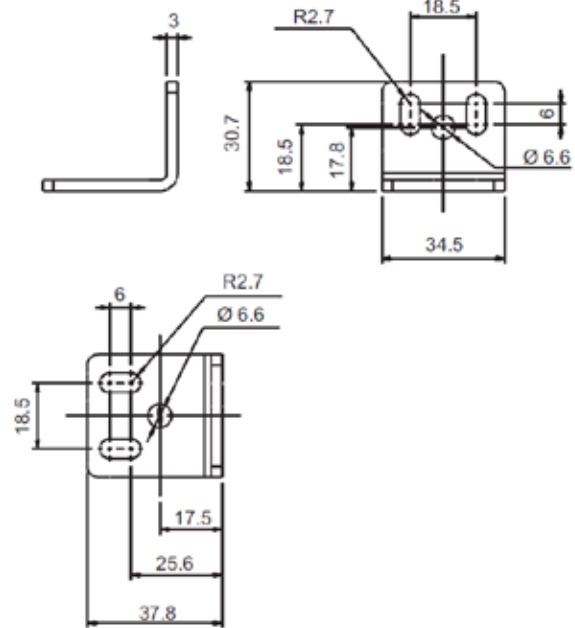

<sup>2</sup> Supplied with the Base model

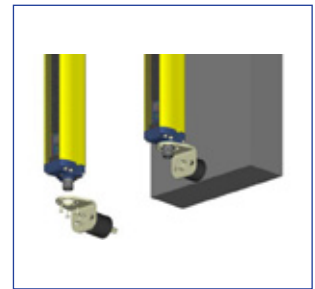
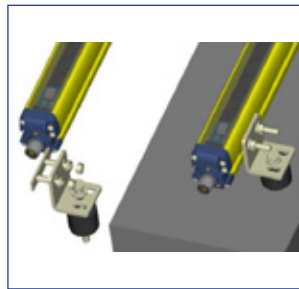
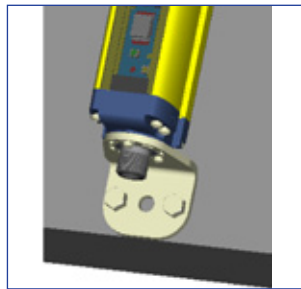

Installation with anti-vibration supports

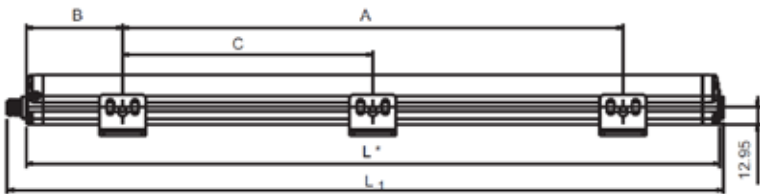

MODELS	L (mm)	A (mm)	B (mm)	C (mm)
SG2-kk-030-OO-*	366.2	216	75	-
SG2-kk-045-OO-*	516.3	316	100	-
SG2-kk-060-OO-*	666.2	366	150	-
SG2-kk-075-OO-*	816.3	466	175	-
SG2-kk-090-OO-*	966.2	566	200	-
SG2-kk-105-OO-*	1116.2	666	225	-
SG2-kk-120-OO-*	1266.3	966	150	483
SG2-kk-135-OO-*	1416.2	1066	175	533
SG2-kk-150-OO-*	1566.3	1166	200	583
SG2-kk-165-OO-*	1716.3	1266	225	633
SG2-kk-180-OO-*	1866.3	1366	250	683

kk = Resolution (50 mm – 90 mm)

\* = X Base model or E-C Extended model

## MODEL SELECTION AND ORDER INFORMATION

Model	Description	Order N°
<b>SG2-B 50 mm</b>		
SG2-50-030-OO-X	Type 2 safety light curtain h=300 mm	957801120
SG2-50-045-OO-X	Type 2 safety light curtain h=450 mm	957801130
SG2-50-060-OO-X	Type 2 safety light curtain h=600 mm	957801140
SG2-50-075-OO-X	Type 2 safety light curtain h=750 mm	957801150
SG2-50-090-OO-X	Type 2 safety light curtain h=900 mm	957801160
SG2-50-105-OO-X	Type 2 safety light curtain h=1050 mm	957801170
SG2-50-120-OO-X	Type 2 safety light curtain h=1200 mm	957801180
SG2-50-135-OO-X	Type 2 safety light curtain h=1350 mm	957801190
SG2-50-150-OO-X	Type 2 safety light curtain h=1500 mm	957801200
SG2-50-165-OO-X	Type 2 safety light curtain h=1650 mm	957801210
SG2-50-180-OO-X	Type 2 safety light curtain h=1800 mm	957801220

Model	Description	Order N°
<b>SG2-E 50 mm</b>		
SG2-50-030-OO-E-C	Type 2 safety light curtain h=300 mm	957801460
SG2-50-045-OO-E-C	Type 2 safety light curtain h=450 mm	957801470
SG2-50-060-OO-E-C	Type 2 safety light curtain h=600 mm	957801480
SG2-50-075-OO-E-C	Type 2 safety light curtain h=750 mm	957801490
SG2-50-090-OO-E-C	Type 2 safety light curtain h=900 mm	957801500
SG2-50-105-OO-E-C	Type 2 safety light curtain h=1050 mm	957801510
SG2-50-120-OO-E-C	Type 2 safety light curtain h=1200 mm	957801520
SG2-50-135-OO-E-C	Type 2 safety light curtain h=1350 mm	957801530
SG2-50-150-OO-E-C	Type 2 safety light curtain h=1500 mm	957801540
SG2-50-165-OO-E-C	Type 2 safety light curtain h=1650 mm	957801550
SG2-50-180-OO-E-C	Type 2 safety light curtain h=1800 mm	957801560

Model	Description	Order N°
<b>SG2-B 90 mm</b>		
SG2-90-030-OO-X	Type 2 safety light curtain h=300 mm	957801230
SG2-90-045-OO-X	Type 2 safety light curtain h=450 mm	957801240
SG2-90-060-OO-X	Type 2 safety light curtain h=600 mm	957801250
SG2-90-075-OO-X	Type 2 safety light curtain h=750 mm	957801260
SG2-90-090-OO-X	Type 2 safety light curtain h=900 mm	957801270
SG2-90-105-OO-X	Type 2 safety light curtain h=1050 mm	957801280
SG2-90-120-OO-X	Type 2 safety light curtain h=1200 mm	957801290
SG2-90-135-OO-X	Type 2 safety light curtain h=1350 mm	957801300
SG2-90-150-OO-X	Type 2 safety light curtain h=1500 mm	957801310
SG2-90-165-OO-X	Type 2 safety light curtain h=1650 mm	957801320
SG2-90-180-OO-X	Type 2 safety light curtain h=1800 mm	957801330

Model	Description	Order N°
<b>SG2-E 90 mm</b>		
SG2-90-030-OO-E-C	Type 2 safety light curtain h=300 mm	957801570
SG2-90-045-OO-E-C	Type 2 safety light curtain h=450 mm	957801580
SG2-90-060-OO-E-C	Type 2 safety light curtain h=600 mm	957801590
SG2-90-075-OO-E-C	Type 2 safety light curtain h=750 mm	957801600
SG2-90-090-OO-E-C	Type 2 safety light curtain h=900 mm	957801610
SG2-90-105-OO-E-C	Type 2 safety light curtain h=1050 mm	957801620
SG2-90-120-OO-E-C	Type 2 safety light curtain h=1200 mm	957801630
SG2-90-135-OO-E-C	Type 2 safety light curtain h=1350 mm	957801640
SG2-90-150-OO-E-C	Type 2 safety light curtain h=1500 mm	957801650
SG2-90-165-OO-E-C	Type 2 safety light curtain h=1650 mm	957801660
SG2-90-180-OO-E-C	Type 2 safety light curtain h=1800 mm	957801670

## RELIABILITY DATA SG2-B SG2-E

PL (Ref. EN ISO 13849-1)	d
CAT (Ref. EN 954-1)	2
SIL (Ref. EN IEC 61508)	2
SIL CL (Ref. EN IEC 62061)	2
PFHD – Probability of Danger Failure (1/h)	1,04E-08
T1 – Life Time (Years)	20
MTTFD - Mean Time to Danger Failure (Years)	273
DC – Diagnostic Coverage (%)	97,50%
SFF – Safe Failure Fraction (%)	98,40%
HFT – Hardware Fault Tolerance	0

## ACCESSORY SELECTION AND ORDER INFORMATION

Model	Description	Order N°
CS-A1-02-U-03	M12 4-pole unshielded axial 3 m connector, UL 2464	95ASE1120
CS-A1-02-U-05	M12 4-pole unshielded axial 5 m connector, UL 2464	95ASE1130
CS-A1-02-U-10	M12 4-pole unshielded axial 10 m connector, UL 2464	95ASE1140
CS-A1-02-U-15	M12 4-pole unshielded axial 15 m connector, UL 2464	95ASE1150
CS-A1-02-U-25	M12 4-pole unshielded axial 25 m connector, UL 2464	95ASE1160
CS-A1-03-U-03	M12 5-pole unshielded axial 3 m connector, UL 2464	95ASE1170
CS-A1-03-U-05	M12 5-pole unshielded axial 5 m connector, UL 2464	95ASE1180
CS-A1-03-U-10	M12 5-pole unshielded axial 10 m connector, UL 2464	95ASE1190
CS-A1-03-U-15	M12 5-pole unshielded axial 15 m connector, UL 2464	95ASE1200
CS-A1-03-U-25	M12 5-pole unshielded axial 25 m connector, UL 2464	95ASE1210
CS-A1-06-U-03	M12 8-pole unshielded axial 3 m connector, UL 2464	95ASE1220
CS-A1-06-U-05	M12 8-pole unshielded axial 5 m connector, UL 2464	95ASE1230
CS-A1-06-U-10	M12 8-pole unshielded axial 10 m connector, UL 2464	95ASE1240
CS-A1-06-U-15	M12 8-pole unshielded axial 15 m connector, UL 2464	95ASE1250
CS-A1-06-U-25	M12 8-pole unshielded axial 25 m connector, UL 2464	95ASE1260
ST-KSTD	Angled fixing brackets (4 pc kit)	95ACC1670
ST-K4AV	Anti-vibration supports (4 pc kit)	95ACC1700
ST-K6AV	Anti-vibration supports (6 pc kit)	95ACC1710
ST-K4ROT	Top-Bottom rotating fixing brackets (4 pc kit)	95ASE1280

Please refer also to **Safety Device Accessories**



The company endeavours to continuously improve and renew its products; for this reason the technical data and contents of this catalogue may undergo variations without prior notice. For correct installation and use, the company can guarantee only the data indicated in the instruction manual supplied with the products.