

S60 SERIES INSTRUCTION MANUAL

CONTROLS

OUTPUT LED (S60...B01/B51/C01/C11/F01/T51)

The yellow LED ON indicates that the N.O. (normally open) output status is closed.

STABILITY LED (S60...B01/B51/C01/C11/F01)

The green LED ON indicates that the received signal has a reserve greater than 30% compared to the output switching value.

POWER ON LED (S60...G00)

The green LED indicates that the sensor is operating.

TRIMMER (S60...B01/B51/C01/C11/F01/T51)

The trimmer can be used to adjust sensitivity; the operating distance increases turning the trimmer clockwise.

WARNING: The trimmer rotation is limited to 270° by a mechanical stop. Do not apply excessive torque when adjusting (max 40 Nmm).

INSTALLATION

The sensor can be positioned by means of the three housing's holes using two screws (M4x25 or longer, 1.5 Nm maximum tightening torque) with washers.

Various orientable fixing brackets to ease the sensor positioning are available (please refer to the accessories listed in the catalogue).

The operating distance is measured from the front surface of the sensor optics.

The M12 connector can be oriented at two different positions using the specific fastening spring and rotating the block of 180°.



CONNECTIONS

The connections are compliant to the EN 60947-5-2 standard.

S60...B01/B51/C01/C11/F01/T51

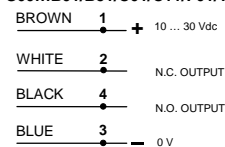

S60...G00

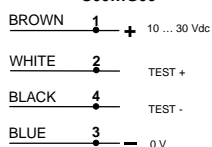

M12 CONNECTOR

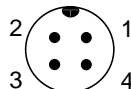

DIMENSIONS

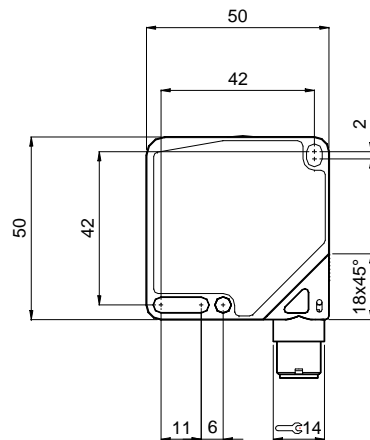

S60...B01/C01/C11/F01/G00

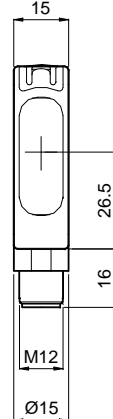

S60...B51/T51

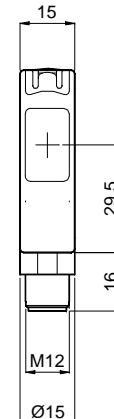

CABLE VERSION

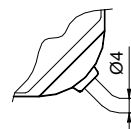

mm

TECHNICAL DATA

Power supply:	10 ... 30 Vdc (limit values)
Ripple:	2 Vpp max.
Current consumption (output current excluded):	35 mA max.
Outputs:	PNP or NPN; 30 Vcc max. (short-circuit protection)
Output current:	100 mA max.
Output saturation voltage:	≤ 2 V
Response time:	0.5 ms mod. B01/B51/T51; 1 ms mod. C01/C11/F01
Switching frequency:	1 kHz mod. B01/B51/T51; 500 Hz max. mod. C01/C11/F01
Indicators:	OUTPUT LED (YELLOW) STABILITY LED (GREEN) (mod. B01/B51/C01/C11/F01) POWER ON LED (GREEN) (mod.G00)
Setting:	sensitivity trimmer (mod. B01/B51/C01/C11/F01/T51)
Operating temperature:	-25 ... 55 °C
Storage temperature:	-25 ... 70 °C
Electrical shock protection:	Class 2
Operating distance (typical values):	B01: 0.1...6 m on R2 B51: 0...3m on R2 (0...2 m on R2 mirror rejection) C01: 1...90 cm C11: 5...200 cm F01/G00: 0...20 m T51: 0...1.5 m on R2
Emission type:	RED (660 nm) mod.B01/B51/C01/T51; INFRARED (880 nm) mod.C11/G00
Ambient light rejection:	according to EN 60947-5-2
Vibrations:	0.5 mm amplitude, 10 ... 55 Hz frequency, for every axis (EN60068-2-6)
Shock resistance:	11 ms (30 G) 6 shock for every axis (EN60068-2-27)
Housing material:	ABS
Lens material:	PMMA window, polycarbonate lens / glass window and lens mod. B51/T51
Mechanical protection:	IP67
Connections:	2 m cable Ø 4 mm / M12-4 pole connector
Weight:	90 g. max. cable vers. / 40 g. max. connector vers.

SETTING

Setting of S60...B01/B51/T51

Position the sensor and reflector aligned on opposite sides. Turn the sensitivity trimmer to the maximum position.

Moving the sensor both vertically and horizontally, determine the power on and off points of the yellow LED (OUT) and then mount the sensor in the middle of the points defined.

Optimum operation is obtained when the green LED (mod.B01/B51) is ON and the yellow LED is OFF.

B01/B51 models: If necessary reduce sensitivity in order to detect very small targets. In order to improve alignment, repeat the procedure detailed above whilst progressively reducing the sensitivity.



T51 model: Turn the sensitivity trimmer counterclockwise until the yellow LED turns ON (pos.A).

Turn slowly the trimmer again clockwise until the yellow LED turns OFF (Operating condition, pos.B).

Setting of S60...F01/G00

Position the sensors aligned on opposite sides.

Turn the sensitivity trimmer to maximum: moving the sensor both vertically and horizontally, determine the power on and off points of the yellow LED (OUT) and then mount the sensor in the middle of the points defined. Optimum operation is obtained when the green LED is ON and the yellow LED is OFF.

If necessary, reduce sensitivity using the trimmer, in order to detect very small targets. In order to improve alignment, repeat the procedure detailed above whilst progressively reducing the sensitivity.

Setting of S60...C01/C11

Turn the sensitivity trimmer to minimum: the green LED is ON, the yellow LED is OFF.

Position the target to detect in front of the sensor.

Turn the sensitivity trimmer clockwise until the yellow LED turns ON (Target detected state, pos.A).

Remove the target, the yellow LED turns OFF.

Turn the sensitivity trimmer clockwise until the yellow LED turns ON (Background detected state, pos.B).

The trimmer reaches maximum if the background is not detected.

Turn the trimmer to the intermediate position C, between the two positions A and B. The green LED must be ON.



TEST FUNCTION (S60...G00)

The TEST+ and TEST- inputs can be used to inhibit the emitter and verify that the system is correctly operating.

The receiver output should switch when the test is activated while the beam is uninterrupted.

The inputs activating voltage range is 10 ... 30 Vdc, whilst respecting the polarity.

The emission is switched off connecting TEST+ to Vdc and TEST- to 0V.

DECLARATION OF CONFORMITY

We DATALOGIC AUTOMATION declare under our sole responsibility that these products are conform to the 2004/108/CE and successive amendments.



WARRANTY

DATALOGIC AUTOMATION warrants its products to be free from defects.

DATALOGIC AUTOMATION will repair or replace, free of charge, any product found to be defective during the warranty period of 36 months from the manufacturing date.

This warranty does not cover damage or liability deriving from the improper application of DATALOGIC AUTOMATION products.

DATALOGIC AUTOMATION

Via Lavino 265 - 40050 Monte S.Pietro - Bologna - Italy

Tel: +39 051 6765611 - Fax: +39 051 6759324

www.automation.datalogic.com e-mail: info.automation.it@datalogic.com

DATALOGIC AUTOMATION cares for the environment: 100% recycled paper. DATALOGIC AUTOMATION reserves the right to make modifications and improvements without prior notification.

Datalogic and the Datalogic logo are registered trademarks of Datalogic S.p.A. in many countries, including the U.S.A. and the E.U.

826001333 Rev.D © Copyright Datalogic 2007-2009