

**ebm-papst St. Georgen GmbH & Co. KG**

Hermann-Papst-Str. 1

D-78112 St. Georgen

Phone +49 (0) 7724 81-0

Fax +49 (0) 7724 81-1309

info2@de.ebmpapst.com

www.ebmpapst.com

Nominal data

Type	7855 ES	
Phase		1~
Nominal voltage	VAC	230
Frequency	Hz	50
Speed (rpm)	min ⁻¹	2800
Power consumption	W	45.0
Min. ambient temperature	°C	-25
Max. ambient temperature	°C	50
Air flow	m ³ /h	325
Sound power level	B	6.0
Sound pressure level	dB(A)	49

ml = Max. load · me = Max. efficiency · fa = Free air · cs = Customer specification · ce = Customer equipment
Subject to change



Technical description

Weight	1.1 kg
Dimensions	Ø 150 x 55 mm
Impeller material	Sheet steel, painted black
Housing material	Die-cast aluminum
Airflow direction	Exhaust over struts
Direction of rotation	Counterclockwise, viewed toward rotor
Storage	Ball bearing
Service life L10 at 40 °C	60000 h
Service life L10 at maximum temperature	47500 h
Cable	To 2 leads. Wire ends with splice. Grounding lug for M4 x 8.
Motor protection	Protected from overload by thermal switch
Approval	VDE, CSA, UL, CE

Product drawing

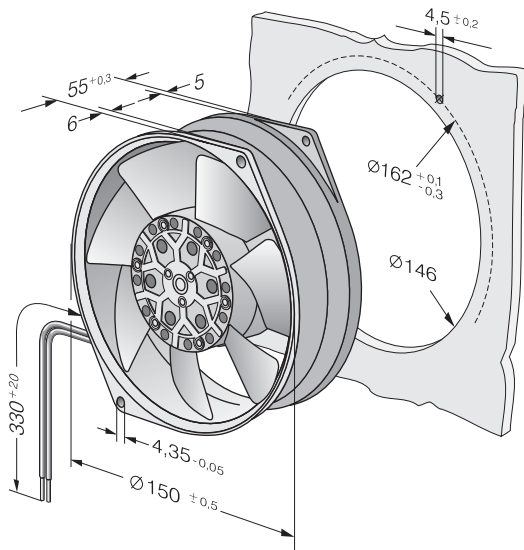

Curves: Air performance

