



S8-PR...M

Background suppression



S8-PR...B

Polarised retroreflex



S8-PR...C

Diffuse proximity



S8-PR...F/G

Receiver/Emitter

INSTRUCTION MANUAL

CONTROLS

OUTPUT LED (yellow) (S8...B/C/M/F)

The yellow LED ON indicates the output status.

POWER ON LED (green)

The green LED ON indicates the powering status and the laser emission presence.

DISTANCE ADJUSTMENT TRIMMER (ADJ.) (S8...M)

The multiturn trimmer with clutch (8 turns) adjusts the suppression distance through the mechanical variation of the optic triangulation angle.

The operating distance increases rotating the trimmer in a clockwise direction. Please refer to "SETTING" paragraph for the correct use procedure.

SENSITIVITY TRIMMER (ADJ.) (S8..B/C/F)

The sensitivity and operating distance can be adjusted using this trimmer. See the "SETTING" paragraph for procedure indications.

LIGHT/DARK TRIMMER

The light/dark mode is selected using a mono-turn trimmer.

Please refer to "SETTING" paragraph for the correct use procedure.

WARNING: the maximum mechanical rotation range of the trimmer is 240°. Do not force over of the maximum and minimum positions.

INSTALLATION

The sensor can be positioned by means of the two housing holes using two screws (M3x18 or longer, 0.8Nm maximum tightening torque) with washers.

Various orientable fixing brackets to ease the sensor positioning are available (please refer to the accessories listed in the general catalogue).

The operating distance is measured from the front surface of the sensor optics.



CONNECTIONS

M8 Connector

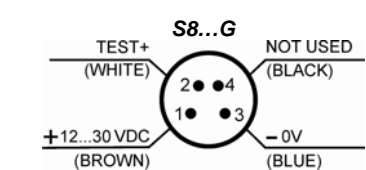
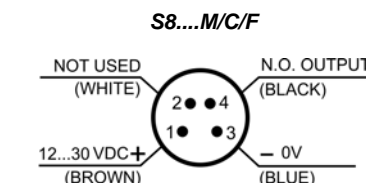
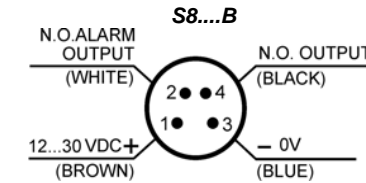

Pig-tail with M12 connector

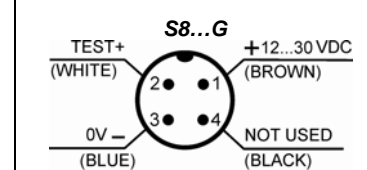
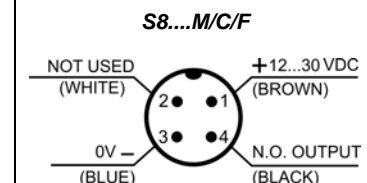
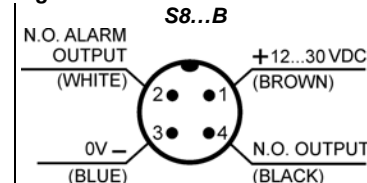

TECHNICAL DATA

	S8...M	S8...B	S8...C	S8...F	S8...G
Power supply:	12 ... 30 VDC				
Ripple:	2 Vpp max.				
Consumption (output current excluded):	35 mA max	30 mA max	20 mA max	15 mA max	
Outputs / Alarm output (only B):	PNP or NPN N.O.; 30 Vdc max. (short-circuit protection)				-
Output current:	100 mA (overload protection)				-
Output saturation voltage:	≤ 2 V				-
Response time:	1ms	500 us			
Switching frequency:	500Hz	1KHz			
Emission type:	RED (660 nm)			-	RED (660 nm)
Operating distance (typical values):	50...300mm	5m on R2, 7m on R5 (EG2)	50cm on 90% white target (EG2)	25m (30m max)	
Regulations	8-turn distance adjustment trimmer	Mono-turn sensitivity adjustment trimmer			-
LIGHT/DARK selection:	Monoturn trimmer				-
Indicators:	OUTPUT LED (yellow) / POWER ON LED (green)			POWER ON LED (green)	
Operating temperature:	-10 ... 55 °C				
Storage temperature:	-20 ... 70 °C				
Dielectric strength:	□: 1500 Vac 1 min. between electronics and housing				
Insulating resistance:	>20 MΩ 500 Vdc between electronics and housing				
Ambient light rejection:	according to EN 60947-5-2				
Vibrations:	0.5 mm amplitude, 10 ... 55 Hz frequency, for each axis (EN60068-2-6)				
Shock resistance:	11 ms (30 G) 6 shocks for each axis (EN60068-2-27)				
Housing material:	ABS				
Lens material:	Window in glass; lens in PC				
Mechanical protection:	IP67				
Connections:	M8 4-pole connector / cable with M12 4-pole connector with 150 mm length and Ø 4 mm (pig-tail)				
Weight:	12 g. max. connector version / 50 g. pig-tail version				

SETTINGS

DARK/LIGHT SETTING

Rotate trimmer in an anti-clockwise direction to set the LIGHT mode (output ON with the reflector).

Rotate trimmer in a clockwise direction to set the DARK mode (output ON in presence of the object).



SUPPRESSION DISTANCE SETTING (S8...M)

1. Object detection (Light mode)

Position object to detect in front of the sensor at the distance required. Turn distance adjustment trimmer (ADJ) to minimum: yellow LED OFF.

Rotate trimmer in a clockwise direction until the yellow LED turns ON. Object detection condition (pos.A).

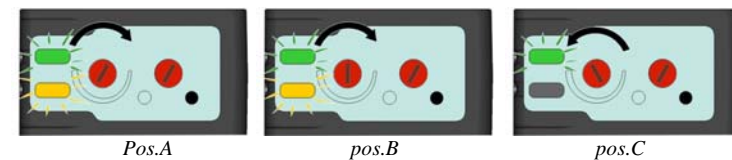

2. Background suppression

Remove object and ensure that the background is in front of the sensor: yellow LED OFF.

Rotate trimmer in a clockwise direction until the yellow LED turns ON: background detection condition (pos.B).

The trimmer reaches maximum level with yellow LED OFF if the background is outside the operating range.

Rotate trimmer in an anticlockwise direction until yellow LED turns OFF: condition where background is outside operating range (pos.C).

3. Setting and control

Rotate trimmer in an anti-clockwise direction until the trimmer reaches an intermediate point between position A and C.

If position A and C are close to each other, leave trimmer on position C. The sensor is now ready to function correctly and in stable conditions.

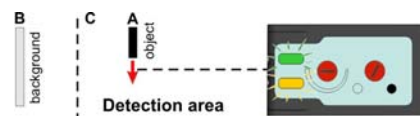

SENSITIVITY SETTING (S8...B)

Alignment:

- Position and align the sensor and reflector on opposite side at the desired distance.

- Rotate sensitivity adjustment trimmer (ADJ.) to maximum point (clockwise direction).

- Move the sensor vertically and horizontally to determine the powering on and powering off points of the yellow LED (OUT) and fix the sensor in the middle of these two points.

- To detect very small objects, reduce the sensitivity using the specific trimmer (if necessary). Repeat procedure reducing progressively the sensitivity to improve alignment.

Control:

- Enter object laterally in the detection area and check that the yellow LED turns ON (in dark mode).

- remove object and check that the yellow LED turns OFF immediately (in dark mode).

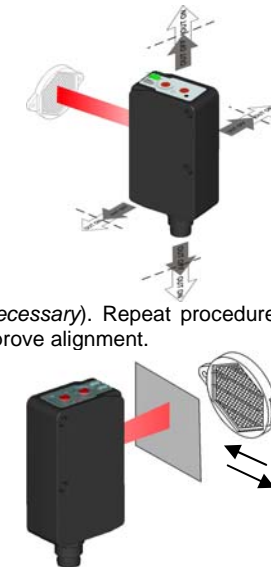

SETTINGS (S8...C)

Turn the sensitivity trimmer to minimum: the yellow LED is OFF (light mode). Position the target to detect in front of the sensor.

Turn the sensitivity trimmer clockwise until the yellow LED turns ON (Target detected state, pos.A).

Remove the target, the yellow LED turns OFF.

Turn the sensitivity trimmer clockwise until the yellow LED turns ON (Background detected state, pos.B).

The trimmer reaches maximum if the background is not detected.

Turn the trimmer to the intermediate position C, between the two positions A and B.



SETTINGS (S8...F/G)

Position the sensors on opposite sides. Turn the sensitivity trimmer to maximum. Find the points where the yellow LED (OUT) is switched ON and OFF in both vertical and horizontal positions, and fix the sensor in the centre between these points. If necessary, reduce sensitivity using the trimmer, in order to detect very small targets. In order to improve alignment, repeat the procedure detailed above whilst progressively reducing the sensitivity.

DIMENSIONS

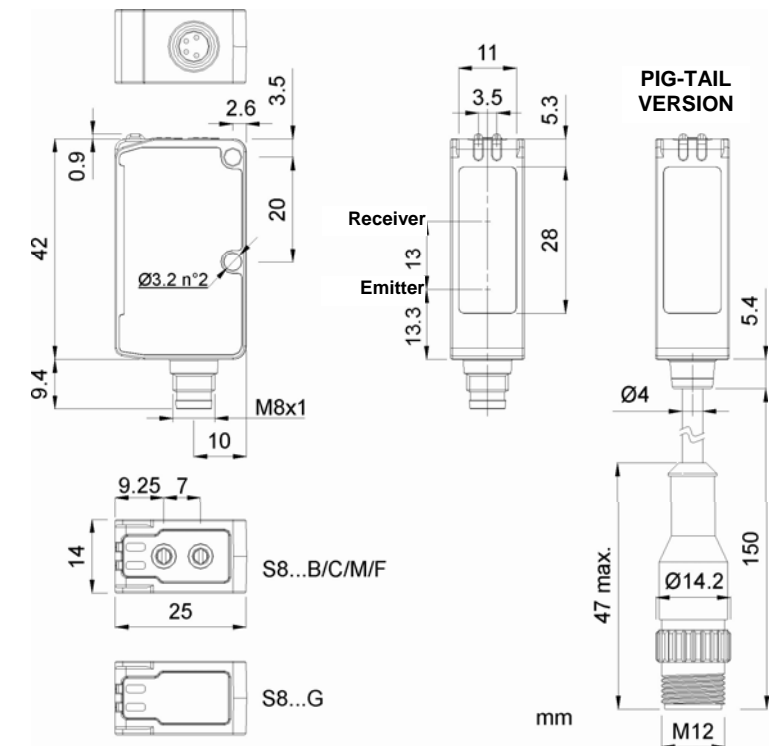

PERFORMANCES (S8..B)

TAB.1: Operative distance

REFLECTOR

R2	R5	RT3970 (60x40mm)
5 m	7 m	2 m

On RT3970 the sensor performances are strongly influenced by the dimensions used.

DETECTION DIAGRAM (S8...M)

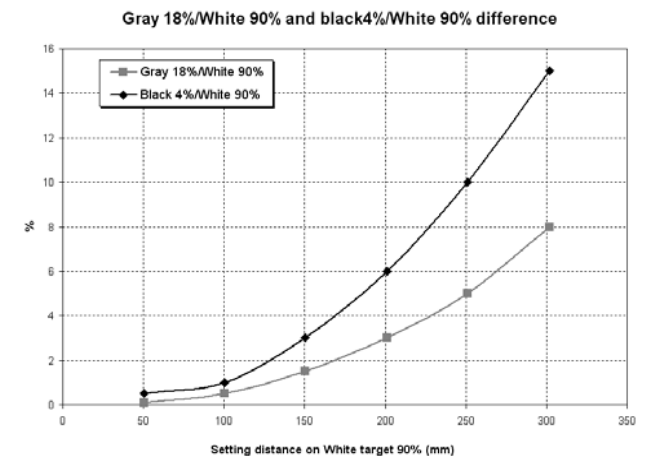

DIAGNOSTIC FUNCTIONS (S8...G)

TEST+ input

The TEST+ input can be used to inhibit the emitter and verify that the system is correctly operating. The TEST function is activated if the TEST+ input is connected to a voltage between 12...30V, whereas if the TEST+ input is connected to GND or it is not connected the function is deactivated.

DECLARATION OF CONFORMITY

We DATALOGIC AUTOMATION declare under our sole responsibility that these products are conform to the 2004/108/CE and successive amendments.



WARRANTY

DATALOGIC AUTOMATION warrants its products to be free from defects. DATALOGIC AUTOMATION will repair or replace, free of charge, any product found to be defective during the warranty period of 36 months from the manufacturing date. This warranty does not cover damage or liability deriving from the improper application of DATALOGIC AUTOMATION products.

DATALOGIC AUTOMATION

Via Lavino 265 - 40050 Monte S.Pietro - Bologna - Italy

Tel: +39 051 6765611 - Fax: +39 051 6759324

www.automation.datalogic.com e-mail:info.automation@datalogic.com



DATALOGIC AUTOMATION cares for the environment: 100% recycled paper. DATALOGIC AUTOMATION reserves the right to make modifications and improvements without prior notification

Datalogic and the Datalogic logo are registered trademarks of Datalogic S.p.A. in many countries, including the U.S.A. and the E.U.