



S8-PH...B Laser
Polarised retroreflex

INSTRUCTION MANUAL



CONTROLS

OUTPUT LED (yellow)
The yellow LED ON indicates the output status.
The yellow LED blinking indicates the alarm status.

POWER ON LED (green)
The green LED ON indicates that the sensor is operating and laser emission is present.

SENSITIVITY TRIMMER (ADJ.)
The sensitivity and operating distance can be adjusted using this trimmer. See the "SETTING" paragraph for procedure indications.

LIGHT/DARK TRIMMER
The light/dark mode can be selected using this mono-turn trimmer. See the "SETTING" paragraph for procedure indications.

WARNING: the maximum trimmer rotation is 240°. Do not apply excessive torque when adjusting.

INSTALLATION

The sensor can be positioned by means of the housing's holes using two screws (M3x18 or longer, 0.8Nm maximum tightening torque) with washers. Various orientable fixing brackets to ease the sensor positioning are available (please refer to the accessories listed in the general catalogue). The operating distance is measured from the front surface of the sensor optics.



CONNECTIONS

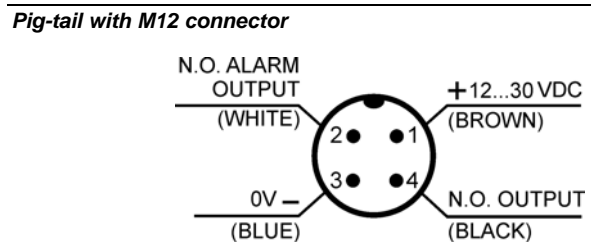
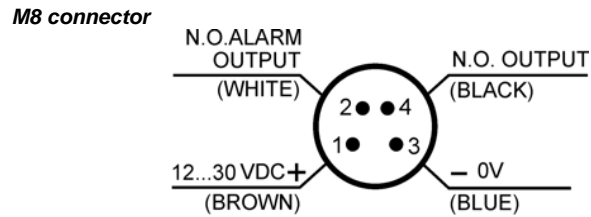

TECHNICAL DATA

Power supply:	12 ... 30 Vdc
Ripple:	2 Vpp max.
Consumption (output current excluded):	30 mA max
Outputs / Alarm output:	PNP or NPN N.O.; 30 VDC max. (short-circuit protection)
Output current:	100 mA (overload protection)
Output saturation voltage:	≤ 2 V
Response time:	50 μs
Switching frequency:	10 kHz
Emission type:	RED LASER (λ = 645...665nm): Class 2 EN 60825-1, Class II CDRH 21 CFR PART 1040.10 Pulsed emission: pot. max ≤ 1,5mW; pulse duration = 3μs; frequency = 40KHz
Focus point:	500 mm
Spot dimension:	< 0.5 mm (a 500 mm)
Operating distance (typical values):	refer to TAB.1
Minimum object detectable:	0.5 mm at 500 mm (minimum spot)
Setting:	Mono-turn sensitivity adjustment trimmer
LIGHT/DARK selection:	Mono-turn trimmer
Indicators:	OUTPUT/ALARM LED (YELLOW) and POWER ON LED (GREEN)
Operating temperature:	-10 ... 55 °C
Storage temperature:	-20 ... 70 °C
Dielectric strength:	1500 VAC 1 min between electronic parts and housing
Insulating resistance:	>20 MΩ 500 VDC between electronic parts and housing
Ambient light rejection:	according to EN 60947-5-2
Vibrations:	0.5 mm amplitude, 10 ... 55 Hz frequency, for every axis (EN60068-2-6)
Shock resistance:	11 ms (30 G) 6 shocks per every axis (EN60068-2-27)
Housing material:	ABS
Lens material:	window in PMMA; lens in PC
Mechanical protection:	IP67
Connections:	M8 4-pole connector / cable with M12 4-pole connector with 150 mm length and Ø 4 mm (pig-tail)
Weight:	12 g. max. connector version / 50 g. pig-tail version

SETTING

SENSITIVITY SETTING

- Alignment:**
- Position and align the sensor and reflector on opposite side at the desired distance.
 - Rotate sensitivity adjustment trimmer (ADJ.) to maximum point (clockwise direction).
 - Move the sensor vertically and horizontally to determine the powering on and powering off points of the yellow LED (OUT) and fix the sensor in the middle of these two points.
 - To detect very small objects, reduce the sensitivity using the specific trimmer (if necessary). Repeat procedure reducing progressively the sensitivity to improve alignment.

Control:

- Enter object laterally in the detection area and check that the yellow LED turns ON (in dark mode).
- remove object and check that the yellow LED turns OFF immediately (in dark mode).

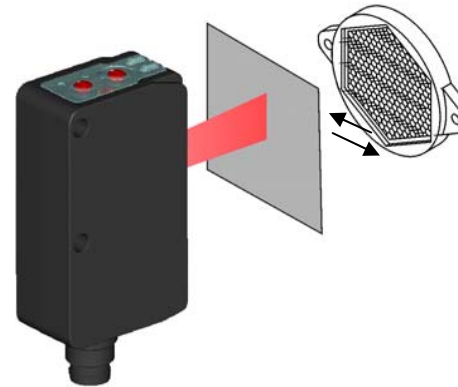
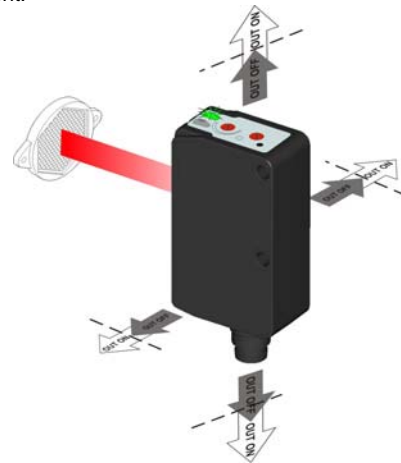

ALARM FUNCTION

The alarm output is active (ON) when the received signal remains without safety margin for more than 1 second (30% respect to output switching value)

DARK/LIGHT SETTING

LIGHT MODE SETTING

Rotate trimmer in an anti-clockwise direction to set the LIGHT mode (output ON with the reflector).

DARK MODE SETTING

Rotate trimmer in a clockwise direction to set the DARK mode (output ON in presence of the object).

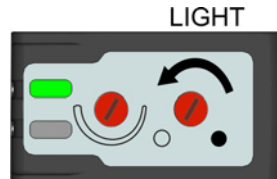

DIMENSIONS

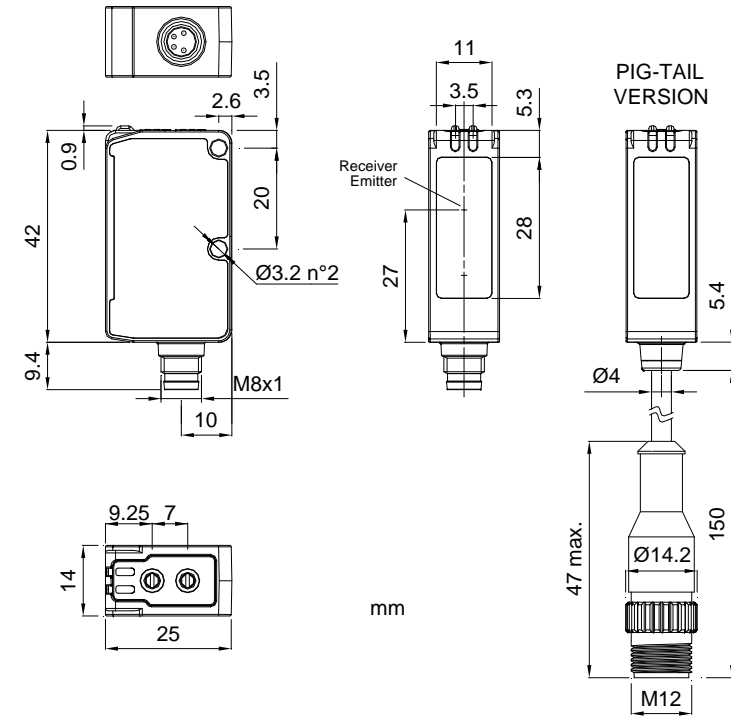

PERFORMANCES

TAB.1: Operating distance

REFLECTOR	R2	R6	R7	R8
	10 m	10 m	12 m	1 m

NOTE: the use of the RT3970 tape is not recommended.

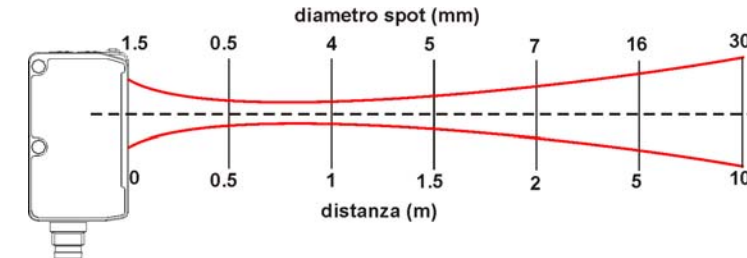

SAFETY WARNINGS

All the safety electrical and mechanical regulations and laws have to be respected during sensor functioning. The sensor has to be protected against mechanical damages. Place the given labels in a visible position close to the laser emission.

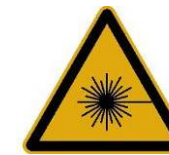

LASER RADIATION P = ≤ 1.5 mW
DO NOT STARE INTO BEAM t_{ON} = 3 μs
CLASS 2 LASER PRODUCT λ = 645...665 nm
IEC 60825-1 (2007)

Do not look directly into the laser beam!
Do not point the laser beam towards people!
Eye irradiation for over 0.25 seconds is dangerous; refer to class 2 standard (EN60825-1). These sensors are not conform to safety applications!

OF CONFORMITY
We DATALOGIC AUTOMATION declare under our sole responsibility that these products are conform to the 2004/108/CE and successive amendments.

WARRANTY
DATALOGIC AUTOMATION warrants its products to be free from defects. DATALOGIC AUTOMATION will repair or replace, free of charge, any product found to be defective during the warranty period of 36 months from the manufacturing date. This warranty does not cover damage or liability deriving from the improper application of DATALOGIC AUTOMATION products.

DATALOGIC AUTOMATION - Via Lavino 265
40050 Monte S. Pietro - Bologna - Italy
Tel: +39 051 6765611 - Fax: +39 051 6759324
www.automation.datalogic.com e-mail: info.automation.it@datalogic.com

DATALOGIC AUTOMATION cares for the environment: 100% recycled paper.
DATALOGIC AUTOMATION reserves the right to make modifications and improvements without prior notification.
Datalogic and the Datalogic logo are registered trademarks of Datalogic S.p.A. in many countries, including the U.S.A. and the E.U.