

DC Square-body Fuses Sizes 300 - 302 - 2x302 gR Brackets size 300 - 1750 to 2000V DC

gRC-gRE from 6 to 125 A

Dimensions

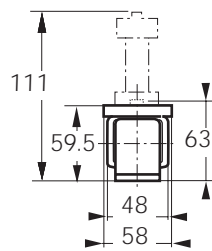
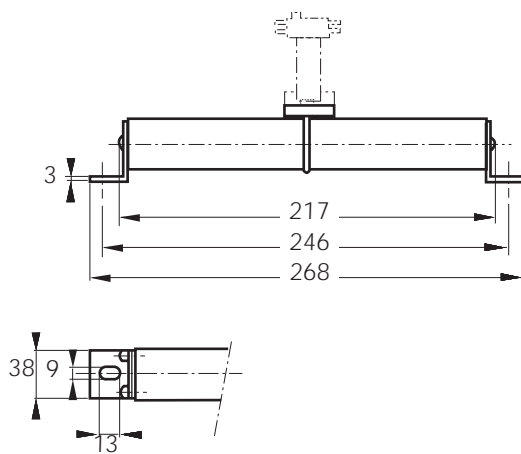

Weight: 1150 g

Main Characteristics

Size	Current rating I_N (A)	Breaking Capacity	Watts loss		Designation	Ref. Number	Catalog Number
			$0.8 I_N$ (W)	I_N (W)			
300	6	@ 1750 V DC 30 kA L/R = 30 ms	3.4	6	CC 17,5 gRC 300 QF 0006	P083733	D300GC17C6QF
	8		4.4	8	CC 17,5 gRC 300 QF 0008	Q083734	D300GC17C8QF
	10		5.8	10.6	CC 17,5 gRC 300 QF 0010	M089435	D300GC17C10QF
	12		6	11	CC 17,5 gRC 300 QF 0012	R087898	D300GC17C12QF
	16		6.7	12	CC 17,5 gRC 300 QF 0016	N089436	D300GC17C16QF
	20		7.9	14	CC 20 gRC 300 QF 0020	R086932	D300GC20C20QF
	25	10	18	CC 20 gRC 300 QF 0025	S086933	D300GC20C25QF	
	32	13.5	24	CC 20 gRC 300 QF 0032	T086934	D300GC20C32QF	
	40	16	29	CC 20 gRC 300 QF 0040	V086935	D300GC20C40QF	
	50	19	34	CC 20 gRC 300 QF 0050	W086936	D300GC20C50QF	
	63	23.5	42.5	CC 20 gRC 300 QF 0063	X086937	D300GC20C63QF	
	80	28.5	51.5	CC 20 gRC 300 QF 0080	Y086938	D300GC20C80QF	
	80	@ 2000 V DC 30 kA L/R = 14 ms	22	40	CC 20 gRE 300 QF 0080	P075752	D300GE20C80QF
	100		28	50	CC 20 gRE 300 QF 0100	Q075753	D300GE20C100QF
	125	@ 1800 V= 100 kA L/R = 20 ms	30	55	CC 20 gRE 300 QF 0125	R075754	D300GE20C125QF

Microswitch: MC R 3E 1-5N Ref. Number: G310023

Pack: 1 piece

FERRAZ SHAWMUT IS MERSEN

MERSEN

sdc44

12/04



DC Square-body Fuses

Sizes 300 - 302 - 2x302

gR Brackets size 300 - 1750 to 2000V DC

gRC-gRE from 6 to 125 A

Electrical characteristics DC applications data

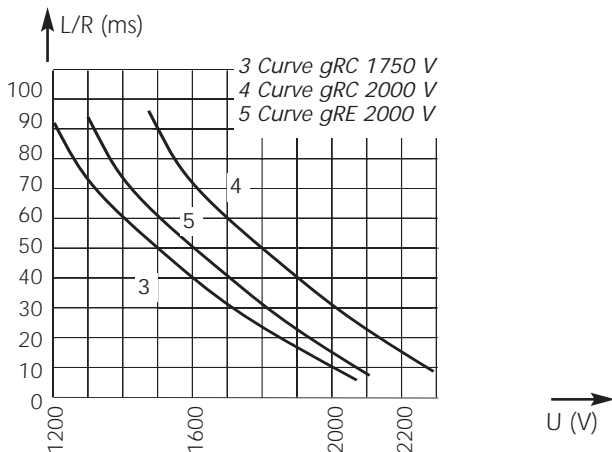

Above: Curves indicate maximum permissible value of time constant L/R as a function of DC working voltage

Max. AC voltage (50/60 Hz):
1,700 V with breaking capacity of 80 kA

Peak arc voltage vs. working voltage

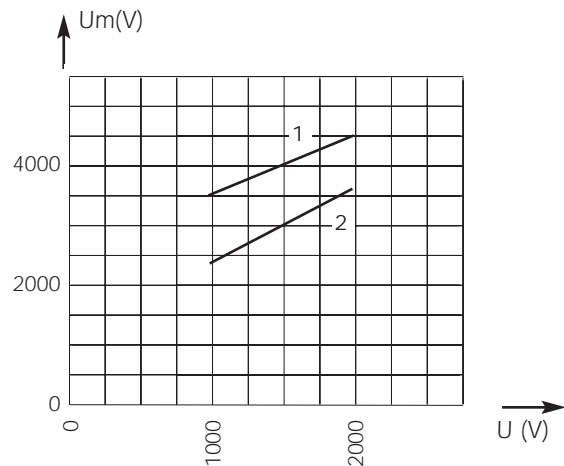

1 Curve gRC : $L/R = 30$ ms
2 Curve gRE : $L/R = 15$ ms

Above: Curves indicate for various time constants L/R the peak arc voltage which may appear across fuse terminals, vs. DC working voltage

Time vs. current characteristics

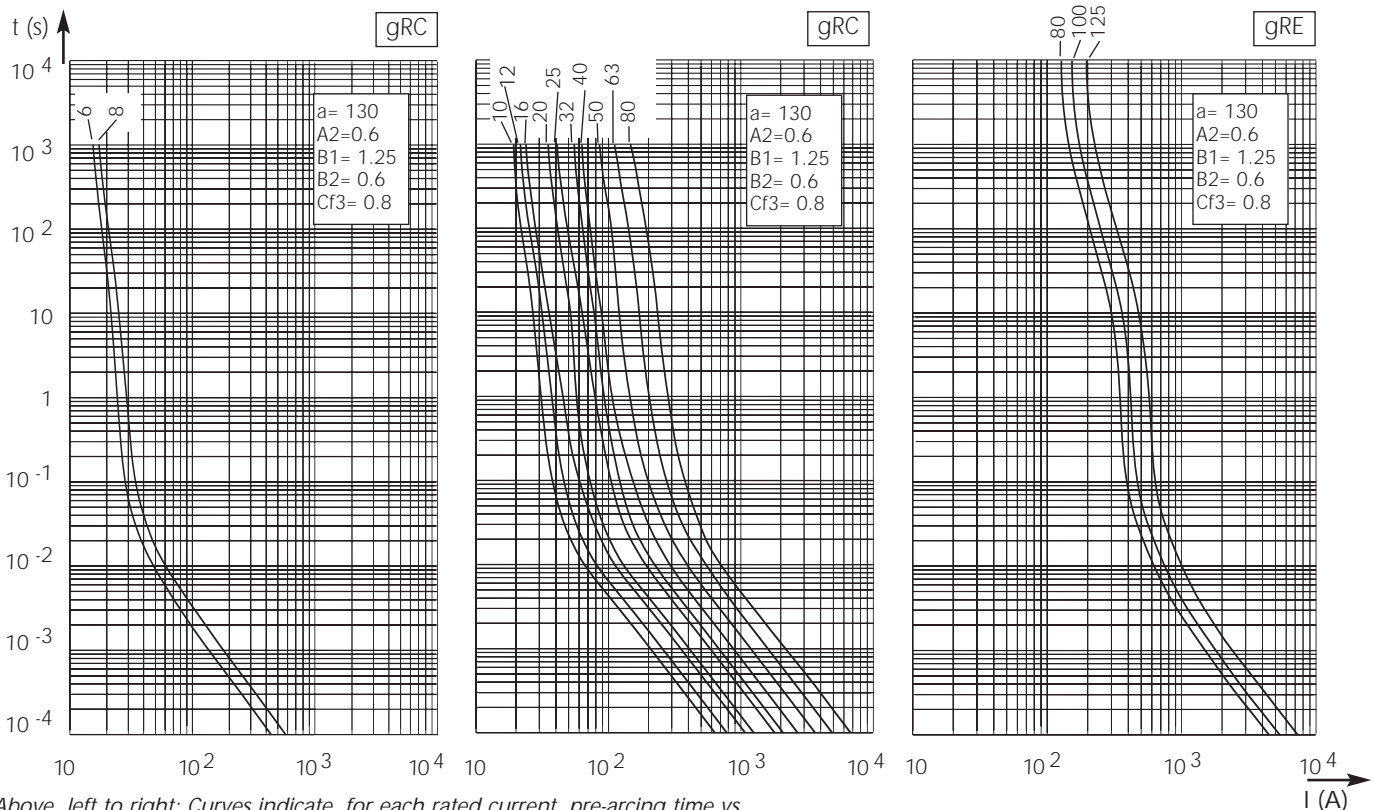

Above, left to right: Curves indicate, for each rated current, pre-arcing time vs. R.M.S. pre-arcing current

$\pm 10\%$ tolerance for mean pre-arcing current

DC Square-body Fuses Sizes 300 - 302 - 2x302 gR Blades size 300 - 1750 to 2000V DC

Size 300
 gRC from 10 to 80 A

Dimensions

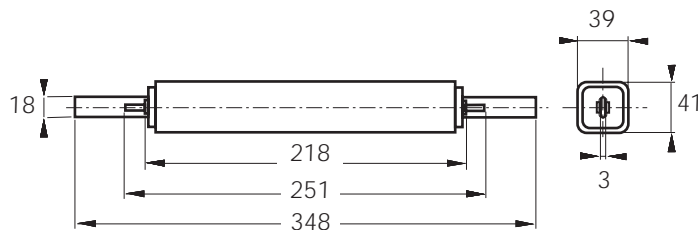

Weight: 1050 g

Main Characteristics

Size	Current rating I_N (A)	Breaking Capacity	Watts loss		Designation	Ref. Number	Catalog Number
			$0.8 I_N$ (W)	I_N (W)			
300	10	@ 1750 V DC	5.8	10.6	CC 17000 CV3 gRC 300PSP 10	Y088870	D 300 GC 17C 10P
	12	30 kA	6	11	CC 17000 CV3 gRC 300PSP 12	X081026	D 300 GC 17C 12P
	16	L/R = 30 ms	6.7	12	CC 17000 CV3 gRC 300PSP 16	L086996	D 300 GC 17C 16P
	20	@ 2000 V DC 30 kA L/R = 30 ms	7.9	14	CC 20000 CV3 gRC 300PSP 20	K086995	D 300 GC 20C 20P
	25		10	18	CC 20000 CV3 gRC 300PSP 25	Q081894	D 300 GC 20C 25P
	32		13.5	24	CC 20000 CV3 gRC 300PSP 32	J086994	D 300 GC 20C 32P
	40		16	29	CC 20000 CV3 gRC 300PSP 40	M086997	D 300 GC 20C 40P
	50		19	34	CC 20000 CV3 gRC 300PSP 50	G086992	D 300 GC 20C 50P
	63		23.5	42.5	CC 20000 CV3 gRC 300PSP 63	F086991	D 300 GC 20C 63P
	80	28.5	51.5	CC 20000 CV3 gRC 300PSP 80	E086990	D 300 GC 20C 80P	

Pack: 1 piece

Microswitch MC 2R 3E 1-5N BS Reference number: J310025

Protistor DC fuses



DC Square-body Fuses

Sizes 300 - 302 - 2x302

gR Blades size 300 - 1750 to 2000V DC

Size 300

gRC-gRE from 200 to 560 A

Electrical characteristics

DC applications data

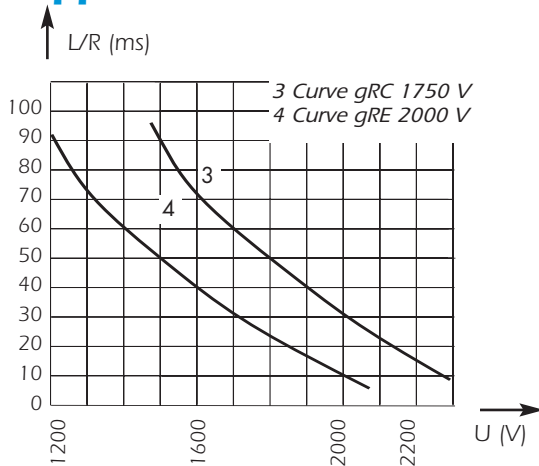

Above: Curves indicate maximum permissible value of time constant L/R as a function of DC working voltage

Max. AC voltage (50/60 Hz):

1700 V with breaking capacity of 80 kA

Time vs. current characteristics

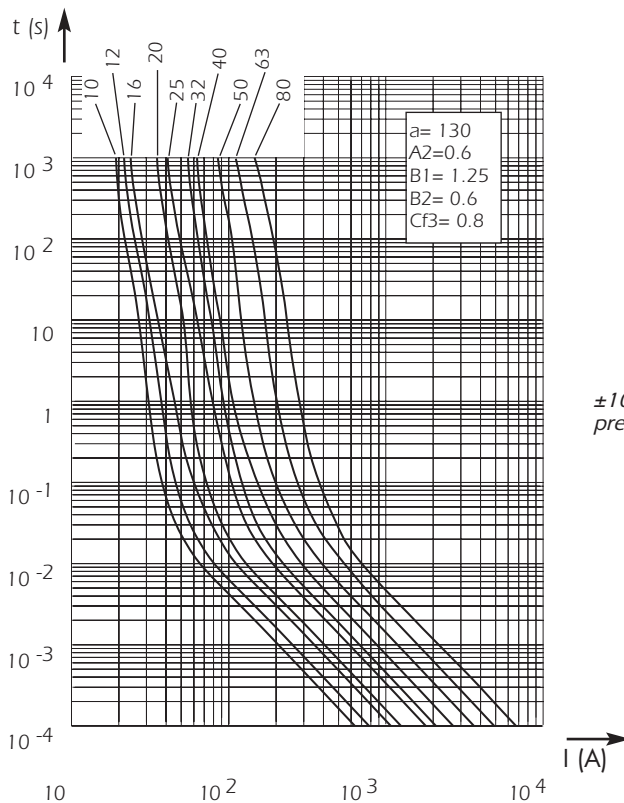

Peak arc voltage vs. working voltage

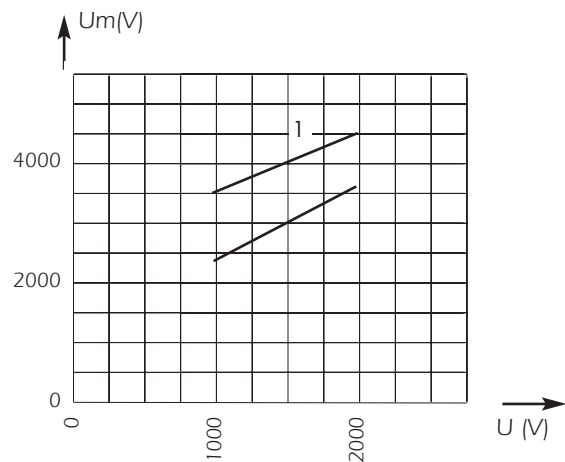

1 Curve gRC : $L/R = 30$ ms

Above: Curves indicate for various time constants L/R the peak arc voltage which may appear across the fuse terminals, vs. DC working voltage

$\pm 10\%$ tolerance for mean pre-arcing current

Above, left and right: Curves indicate, for each rated current, pre-arcing time vs. R.M.S. pre-arcing current