

MLC 9000+

User Guide

59327-4



Price: **£11.00**
 €15.00
 \$15.00

Information in this installation, wiring and operation manual is subject to change without notice.

Copyright © May 2004, Danaher ICG, all rights reserved. No part of this publication may be reproduced, transmitted, transcribed or stored in a retrieval system, or translated into any language in any form by any means without the written permission of the manufacturer.

Note:

It is strongly recommended that applications incorporate a high or low limit protective device, which will shut down the equipment at a preset process condition in order to prevent possible damage to property or products.



WARNING: THE INTERNATIONAL HAZARD SYMBOL IS INSCRIBED ADJACENT TO THE CONNECTION TERMINALS. IT IS IMPORTANT TO READ THIS MANUAL BEFORE INSTALLING OR COMMISSIONING THE UNIT.

Warranty and Returns Statement

These products are sold under the warranties set forth in the following paragraphs. Such warranties are extended only with respect to a purchase of these products, as new merchandise, directly from a distributor, representative or reseller and are extended only to the first buyer thereof who purchases them other than for the purpose of resale.

Warranty

These products are warranted to be free from functional defects in material and workmanship at the time the products leave the factory and to conform at that time to the specifications set forth in the relevant instruction manuals sheet or sheets, for such products for a period of three years.

THERE ARE NO EXPRESSED OR IMPLIED WARRANTIES, WHICH EXTEND BEYOND THE WARRANTIES HEREIN AND ABOVE SET FORTH. WEST MAKES NO WARRANTY OF MERCHANTABILITY OR FITNESS FOR A PARTICULAR PURPOSE WITH RESPECT TO THE PRODUCTS.

Limitations

The supplier shall not be liable for any incidental damages, consequential damages, special damages, or any other damages, costs or expenses excepting only the cost or expense of repair or replacement as described above. Products must be installed and maintained in accordance with the instructions. There is no warranty against damage to the product resulting from corrosion. Users are responsible for the suitability of the products to their application.

For a valid warranty claim, the product must be returned carriage paid to the supplier within the warranty period. The product must be properly packaged to avoid damage from Electrostatic Discharge or other forms of harm during transit

CONTENTS

1	MLC 9000 [®] SYSTEM OVERVIEW.....	1-1
2	INSTALLATION.....	2-1
2.1	General.....	2-1
2.2	Installing a Bus Module.....	2-2
2.3	Installing the Loop Modules and Interconnect Module.....	2-2
2.4	Removing a Bus Module.....	2-3
2.5	Removing a Loop Module.....	2-3
2.6	Removing an Interconnect Module.....	2-3
2.7	Precautions Whilst Wiring.....	2-4
2.7.1	Installation Considerations.....	2-4
2.7.2	Wire Isolation.....	2-4
2.7.3	Use of Shielded Cable.....	2-4
2.7.4	Noise Suppression at Source.....	2-4
2.7.5	Sensor Placement (Thermocouple or RTD).....	2-5
2.8	Electrical Connections – Bus Module.....	2-6
2.8.1	Power Input.....	2-6
2.8.2	Configuration Port.....	2-6
2.8.3	FieldBus Port – RS485 MODBUS (BM220-MB only).....	2-6
2.8.4	FieldBus Port – DeviceNet (BM230-DN).....	2-7
2.8.5	FieldBus Port – PROFIBUS-DP (BM240-PB only).....	2-7
2.8.6	FieldBus Port – Ethernet/IP & MODBUS/TCP (BM250-EI or MT).....	2-7
2.9	Electrical Connections – Loop Module.....	2-8
2.9.1	Thermocouple Inputs.....	2-9
2.9.2	RTD Input (3-Wire).....	2-9
2.9.3	Linear Inputs.....	2-9
2.9.4	Single Loop Heater Current Input (Z1301).....	2-10
2.9.5	Multiple Loop Heater Current Input (Z3611, Z3621, Z3651).....	2-11
2.9.6	SSR Driver Outputs.....	2-12
2.9.7	Relay Outputs.....	2-12
2.9.8	Linear Output.....	2-12
3	GETTING STARTED.....	3-1
3.1	Installing MLC 9000+ Workshop.....	3-1
3.2	Running MLC 9000+ Workshop.....	3-1
3.3	System Configuration.....	3-1
3.4	Configuration Wizards.....	3-2
3.5	Configuring the Fieldbus Communications (Data Assemblies).....	3-4
3.6	Saving a System Configuration.....	3-5
3.7	Generating the GSD/EDS file.....	3-5
3.8	Downloading the Configuration to the MLC 9000+.....	3-5
3.9	Adjusting and Monitoring a Live system.....	3-6
4	PARAMETER DESCRIPTIONS.....	4-1
4.1	Input Parameters.....	4-1
4.1.1	Process Variable (PV) Value.....	4-1
4.1.2	Input Filter Time Constant.....	4-1
4.1.3	Process Variable Offset.....	4-1
4.1.4	Over-range Flag.....	4-1
4.1.5	Under-range Flag.....	4-2
4.1.6	Sensor Break Flag.....	4-2
4.1.7	Input Range (Type / Span).....	4-2
4.1.8	Input Units.....	4-2
4.1.9	Input Scale Range Maximum.....	4-3
4.1.10	Input Scale Range Minimum.....	4-3
4.1.11	External Input Value.....	4-4
4.2	Output Parameters.....	4-4
4.2.1	Output Type.....	4-4
4.2.2	Alarm Output Definition 1 to 4.....	4-4
4.2.3	Output Usage.....	4-5
4.2.4	Output Cycle Time.....	4-5
4.2.5	Output State.....	4-5
4.2.6	Output Loop.....	4-6
4.2.7	DC Linear Output Scale Maximum (Modules Z1300 and Z1301 only).....	4-6

4.2.8	DC Linear Output Scale Minimum (Modules Z1300 and Z1301 only)	4-6
4.2.9	Bus Power	4-6
4.3	Setpoint Parameters	4-7
4.3.1	Setpoint 1	4-7
4.3.2	Setpoint 2	4-7
4.3.3	Setpoint Select	4-7
4.3.4	Actual Setpoint	4-7
4.3.5	Setpoint Ramp Rate	4-8
	Control Parameters	4-9
4.4		4-9
4.4.1	Control Bits	4-9
4.4.2	Manual Control Enable/Disable	4-9
4.4.3	Loop Enable/Disable	4-9
4.4.4	Manual Power	4-10
4.4.5	Enable/Disable Continuous Self-tune Facility	4-10
4.4.6	Enable/Disable Easy-tune	4-10
4.4.7	Auto Easy-tune	4-12
4.4.8	Enable/Disable Pre-tune	4-12
4.4.9	Auto Pre-tune	4-13
4.4.10	Primary Output Power Limit	4-13
4.4.11	Soft Start Parameters	4-14
4.4.12	Primary Output Power	4-15
4.4.13	Secondary Output Power	4-15
4.4.14	Loop Alarm Enable	4-15
4.4.15	Loop Alarm Status	4-16
4.4.16	Control Type	4-16
4.4.17	Proportional Band 1	4-16
4.4.18	Proportional Band 2	4-17
4.4.19	Reset (Integral Time Constant)/Loop Alarm Time	4-17
4.4.20	Rate (Derivative Time Constant)	4-17
4.4.21	Overlap and Deadband	4-18
4.4.22	Bias (Manual Reset)	4-19
4.4.23	ON/OFF Differential	4-19
4.4.24	Control Output Action	4-19
4.4.25	Programmable Sensor Break	4-19
4.4.26	Preset Power Output	4-20
4.5	Alarm Parameters	4-21
4.5.1	Alarm Type	4-21
4.5.2	Alarm Hysteresis	4-22
4.5.3	Alarm Value	4-23
4.5.4	Alarm State	4-23
4.5.5	Alarm Inhibit	4-23
4.6	4.6 Heater Current Parameters	4-23
4.6.1	Heater Current value	4-23
4.6.2	Heater Current Input Type	4-23
4.6.3	Heater Current Scale Range Maximum	4-24
4.6.4	Low Heater Break Alarm value	4-24
4.6.5	High Heater Break Alarm value	4-25
4.6.6	Low Heater Break Alarm state	4-25
4.6.7	High Heater Break Alarm state	4-25
4.6.8	Short Circuit Heater Break Alarm Enable/Disable	4-25
4.6.9	Short Circuit Heater Break Alarm state	4-26
4.6.10	Heater Current Bus Input value	4-26
4.6.11	Heater Period (Modules Z3621, Z3611 and Z3651 only)	4-26
4.7	Calibration Parameters	4-27
4.7.1	Calibration Phase	4-27
4.7.2	Calibration Password	4-27
4.8	Loop Module Descriptor Parameters	4-28
4.8.1	Serial Number	4-28
4.8.2	Firmware ID	4-28
4.8.3	Date of Manufacture	4-28
4.8.4	Product Identifier	4-28
4.8.5	Loop Module Status indicators	4-29
	Bus Module Communication Port Parameters	4-29
4.9		4-29

4.9.1	Configuration Port Data Rate	4-29
	Bus Module Descriptor Parameters	4-29
4.10	4-29
4.10.1	Serial Number	4-29
4.10.2	Date of Manufacture.....	4-29
4.10.3	Product Identifier.....	4-30
4.10.4	Database ID.....	4-30
4.11	Data Assemblies.....	4-30
4.11.1	Startup and Removal of Loop Modules.....	4-31
5	OVERVIEW OF MODBUS RTU COMMUNICATIONS (BM220-MB)	5-1
5.1	Introduction.....	5-1
5.2	Interface Configuration	5-1
5.3	MODBUS Functions Supported.....	5-1
5.3.1	Read Coil/Input Status (Function 01/02).....	5-2
5.3.2	Read Holding/Input Registers (Function 03/04).....	5-2
5.3.3	Force Single Coil (Function 05).....	5-2
5.3.4	Preset Single Register (Function 06).....	5-3
5.3.5	Loopback Diagnostic Test (Function 08).....	5-3
5.3.6	Force Multiple Coils (Function 0x0F).....	5-3
5.3.7	Preset Multiple Registers (Function 0x10).....	5-3
5.3.8	Read/Write Multiple Registers (Function 0x17).....	5-4
5.3.9	Exception Responses.....	5-4
5.4	Using the Data Assemblies.....	5-4
5.5	Addressing Individual Parameters	5-6
5.6	Diagnostics and Fault Finding	5-7
5.7	CRC Checksum Calculation	5-8
6	OVERVIEW OF DeviceNet COMMUNICATIONS (BM230-DN)	6-1
6.1	Introduction.....	6-1
6.2	Interface Configuration	6-1
6.3	DeviceNet Messages.....	6-1
6.3.1	Input/Output Messages (Data Assemblies).....	6-1
6.3.2	Explicit Messages	6-2
6.4	Creating the DeviceNet .eds file	6-3
7	OVERVIEW OF PROFIBUS COMMUNICATIONS (BM240-PB).....	7-1
7.1	Introduction.....	7-1
7.2	Interface Configuration	7-1
7.3	PROFIBUS Messages.....	7-1
7.3.1	Cyclic Messages (Data Assemblies).....	7-1
7.3.2	Acyclic Messages.....	7-2
7.4	Official approved Profibus GSD File	7-2
7.5	Creating the PROFIBUS .gsd/gse file.....	7-2
8	OVERVIEW OF Ethernet/IP COMMUNICATIONS (BM250-EI)	8-1
8.1	Introduction.....	8-1
8.2	Interface Configuration	8-1
8.3	Ethernet/IP Messages	8-1
8.3.1	Input/Output Connection (Data Assemblies).....	8-1
8.4	Creating the Ethernet/IP .eds file.....	8-2
9	OVERVIEW OF MODBUS/TCP COMMUNICATIONS (BM250-MT).....	9-1
9.1	Introduction.....	9-1
9.2	Interface Configuration	9-1
9.3	MODBUS/TCP Functions Supported.....	9-1
9.3.1	Read Coil/Input Status (Function 01/02).....	9-2
9.3.2	Read Holding/Input Registers (Function 03/04)	9-2
	Force Single Coil (Function 05).....	9-2
9.3.3	9-2
9.3.4	Preset Single Register (Function 06).....	9-2
9.3.5	Loopback Diagnostic Test (Function 08).....	9-3
9.3.6	Force Multiple Coils (Function 0x0F).....	9-3
9.3.7	Preset Multiple Registers (Function 0x10).....	9-3
9.3.8	Read/Write Multiple Registers (Function 0x17).....	9-4
9.3.9	Exception Responses.....	9-4
9.4	Using the Data Assemblies.....	9-4
9.5	Addressing Individual Parameters	9-6
APPENDIX A	PARAMETER ADDRESSES	1
A1	Input Parameters	2

- A1.1 Input 1 Parameters2
- A1.2 Input 2 Parameters2
- A1.3 Input 3 Parameters3
- A1.4 Input 4 Parameters3
- A2 Output Parameters4
 - A2.1 Output 1 Parameters.....4
 - A2.2 Output 2 Parameters.....4
 - A2.3 Output 3 Parameters.....5
 - A2.4 Output 4 Parameters.....5
 - A2.5 Output 5 Parameters.....6
 - A2.6 Output 6 Parameters.....6
- A3 Setpoint Parameters.....7
 - A3.1 Loop 1 Setpoint Parameters7
 - A3.2 Loop 2 Setpoint Parameters7
 - A3.3 Loop 3 Setpoint Parameters7
 - A3.4 Loop 4 Setpoint Parameters7
- A4 Control Parameters8
 - A4.1 Loop 1 Control Parameters.....8
 - A4.2 Loop 2 Control Parameters.....9
 - A4.3 Loop 3 Control Parameters.....10
 - A4.4 Loop 4 Control Parameters.....11
- A5 Alarm Parameters.....12
 - A5.1 Loop 1, Alarm 1 Parameters12
 - A5.2 Loop 1, Alarm 2 Parameters12
 - A5.3 Loop 2, Alarm 1 Parameters12
 - A5.4 Loop 2, Alarm 2 Parameters12
 - A5.5 Loop 3, Alarm 1 Parameters13
 - A5.6 Loop 3, Alarm 2 Parameters13
 - A5.7 Loop 4, Alarm 1 Parameters13
 - A5.8 Loop 4, Alarm 2 Parameters13
- A6 Heater Current Parameters14
 - A6.1 Loop 1 Heater Current Parameters.....14
 - A6.2 Loop 2 Heater Current Parameters.....14
 - A6.3 Loop 3 Heater Current Parameters.....15
- A7 Loop Module Descriptor Parameters.....16
- A8 Bus Module Descriptor Parameters.....16
- APPENDIX B TECHNICAL SPECIFICATIONS 1
 - B1 Bus Module1
 - B2 Loop Modules2
 - B3 MLC 9000+ Workshop System Requirements4
- APPENDIX C PRODUCT CODING1
- APPENDIX D Bus Module and Loop Module Diagnostic LED's Definition.....1
 - D1 Bus Module Configuration port LED (RS232)1
 - D2 MODBUS RTU LED Diagnostics1
 - D3 DeviceNet LED Diagnostics.....1
 - D4 PROFIBUS LED Diagnostics2
 - D5 Ethernet/IP LED Diagnostics2
 - D6 MODBUS/TCP LED Diagnostics3
 - D8 Loop Module LED Diagnostics3

1 MLC 9000+ SYSTEM OVERVIEW

The MLC 9000+ is a DIN rail -mounted multi-loop PID control system that can be connected to a variety of fieldbus systems. The MLC 9000+ system consists of a single Bus Module and any combination of up to 8 Loop Modules.

The Bus Module is a supervisory module (figure 1.2). It provides power to the Loop Modules and contains a back-up of the system configuration data it also manages the communications with external devices. The Bus Module is connected directly to the DIN rail

The Loop Modules are independent control modules that are managed by the Bus Module (figure 1.3). The Loop Modules are connected to the DIN rail via an inter-connect module that provides power and a communications link to the Bus Module. Any combination of Loop Module types can be connected to the Bus Module as long as the maximum of eight modules is not exceeded.

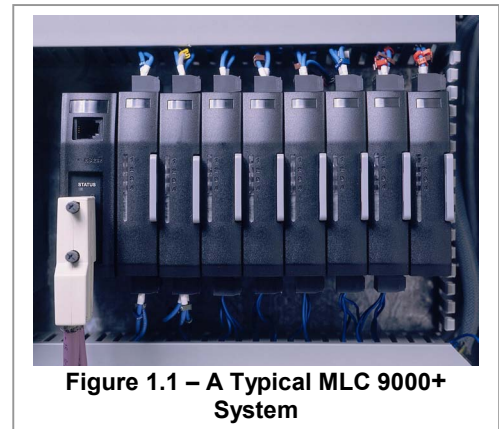

Figure 1.1 – A Typical MLC 9000+ System

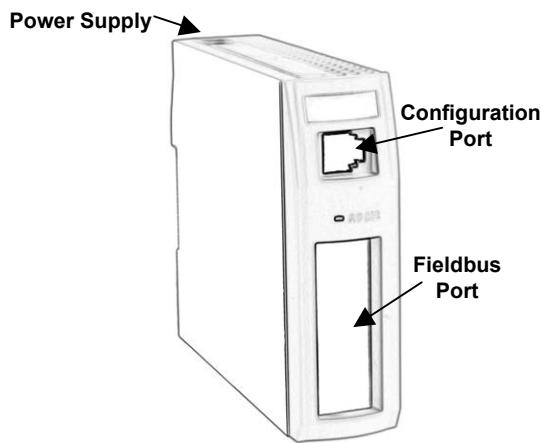

Figure 1.2 - Bus Module (fitted on DIN mounting rail)

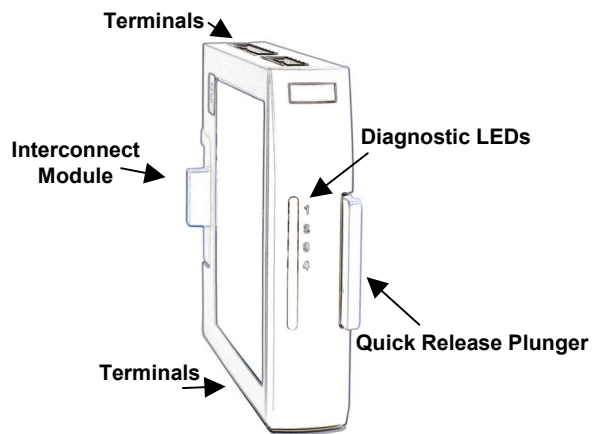

Figure 1.3 - Loop Module (fitted on DIN mounting rail via Interconnect Module)



NOTE: The maximum number of Loop Modules on any Bus Module system is eight. For more Loop Modules multiple Bus Modules can be used; *this maximum must not be exceeded.*

Figure 1.4 shows a block diagram of a MLC 9000+ system. On power-up or system reset, addresses are assigned to the Loop Modules automatically according to their physical position in the MLC 9000+ system; the left-most Loop Module i.e. the one nearest the Bus Module has Address 1, the next Loop Module to the right has Address 2 and so on (see right).

If any Loop Module position is unoccupied (i.e. has only the Interconnect Module), the appropriate address is still assigned to that position. The fact that there is no Loop Module in that position is detected by the Bus Module.

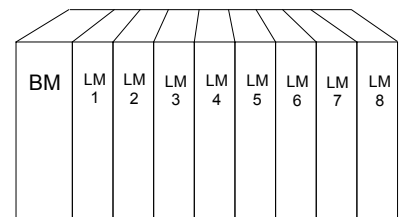

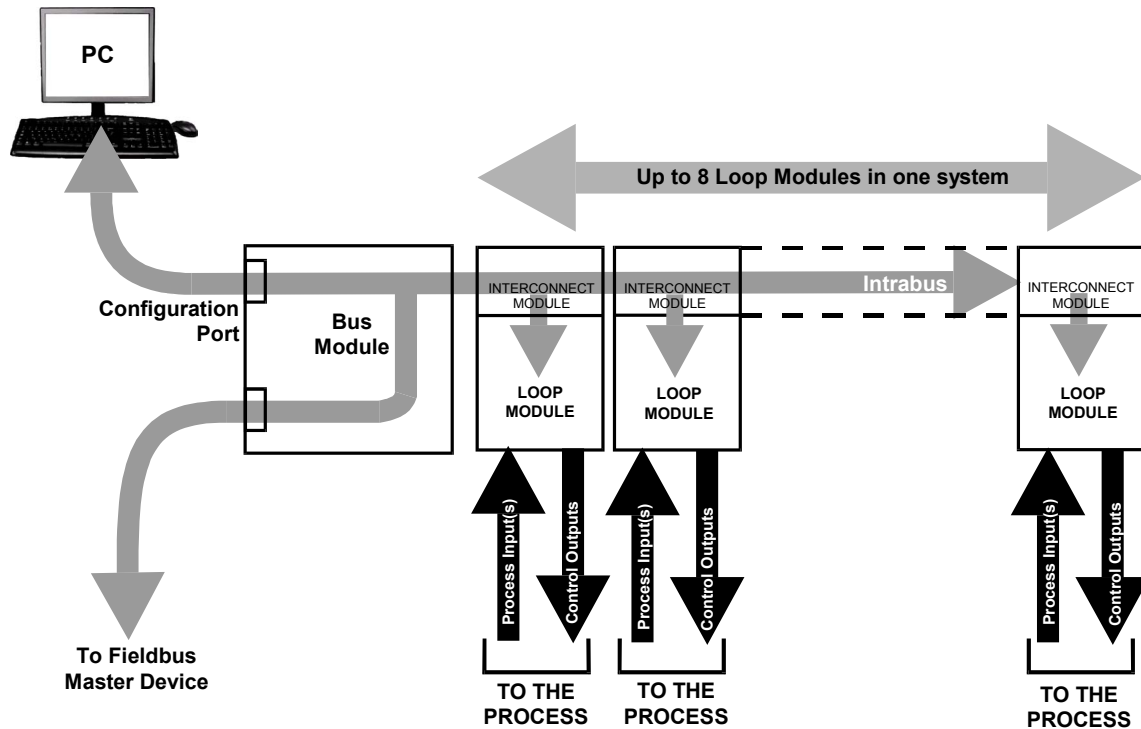

Figure 1.4 - Typical MLC 9000+ System Block Diagram

The Bus Module manages the communications between the outside world and the Loop Controller modules. The configuration port is used for connection to a RS 232 port on a PC running the MLC 9000+ configuration software. The fieldbus port is used for connection to a supervisory system via one of the supported fieldbus protocols. The Bus module comes in 5 different hardware build variants and 7 firmware variations.

The ranges of Bus Modules available are:

Bus Module Type	Description
BM210-NF	24-volt supply, PC Port
BM220-MB	24-volt supply, PC Port and RS485 Port installed with MODBUS Firmware
BM230-DN	24-volt supply, PC Port and CAN Port installed with DeviceNet Firmware
BM230-CO	24-volt supply, PC Port and CAN Port installed with CANopen Firmware
BM240-PB	24-volt supply, PC Port and PROFIBUS Port installed with PROFIBUS-DP Firmware
BM250-EI	24-volt supply, PC Port and Ethernet Port installed with Ethernet/IP Firmware
BM250-MT	24-volt supply, PC Port and Ethernet Port installed with MODBUS/TCP Firmware

A Loop Module is an independent control module that is supervised by the Bus Module. When power is applied to the MLC 9000+, after the Loop Modules are addressed, the Bus Module checks what variant of Loop Module is fitted and downloads its configuration. If the Loop Module does not match the Bus Modules image then a download is not implemented and the Loop Module is kept in an inhibited state. This also applies when a Loop Module changed while power is applied (Hot Swap).

The range of Loop Modules available includes:

Loop Module Type	Description
Z1200	One Universal input, two SSR/relay outputs
Z1300	One Universal input, two SSR/relay outputs and one Linear output or three SSR/relay outputs (selectable)
Z1301	One Universal input, one Heater Break input, two SSR/relay outputs and one Linear output or three SSR/SP relay outputs
Z3621	Three Universal inputs, one Heater Break input, six SSR outputs
Z3611	Three Universal inputs, one Heater Break input, six relay outputs
Z3651	Three Universal inputs, one Heater Break input, three SSR outputs and three relay outputs
Z4620	Four Universal inputs, six SSR outputs
Z4610	Four Universal inputs, six relay outputs
Z4660	Four Universal inputs, four SSR outputs and 2 relay outputs

All relays are Single Pole Single Throw (SPST)
 For full details of modules and options available, refer to Appendix C.

2 INSTALLATION



Only personnel competent and authorised to do so should perform the procedures in this Section. All local and national regulations regarding electrical safety must be rigidly observed.



2.1 General

The MLC 9000+ System - is designed for installation in an enclosure which is sealed against the ingress of dust and moisture. The enclosure must contain sufficient length of 35mm Top-Hat DIN mounting rail to accommodate the system modules, DIN rail clamps (see below) plus an extra 50mm of rail to permit modules to be separated for removal/replacement. The space required by the MLC 9000+ modules is shown in [Figure 2.1](#).

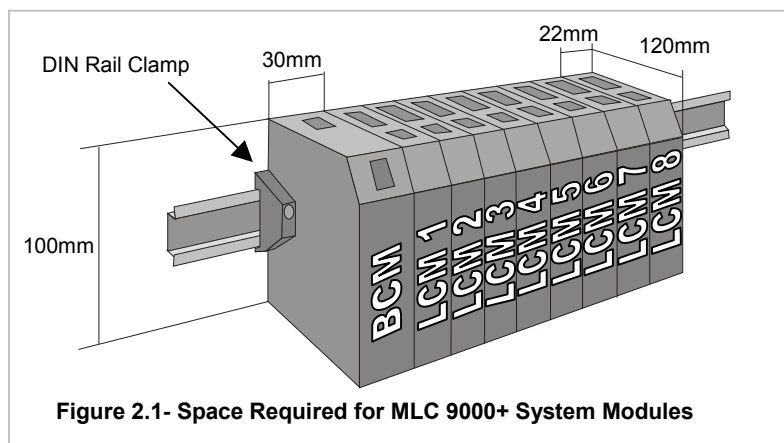

NOTE: An additional 60mm of space is required above and below the system modules to permit ventilation and to accommodate wiring bend radii to enclosure trunking or conduits. Allow sufficient slack in all cables inside the trunking to permit “hot” swapping of modules (i.e. modules to be removed/replaced whilst the system is under power).

WARNING: The maximum of eight Loop Modules per Bus Module must not be exceeded.

It is recommended that (a) some means of preventing unauthorised access to the enclosure interior (e.g. lockable doors) is provided, and (b) that a suitable DIN rail clamp be used, once the MLC 9000+ system is fully installed, to prevent the system from moving on the DIN rail. Under normal circumstances, no forced ventilation is required and the enclosure need not contain ventilation slots, but temperatures within the enclosure must be within specification (see Appendix B).

The modules are installed onto the DIN rail in the following order:

1. Bus Communications Module
2. Interconnect Module(s)
3. First Loop Controller Module
4. Second Loop Controller Module
5. Third Loop Controller Module etc.

2.2 Installing a Bus Module

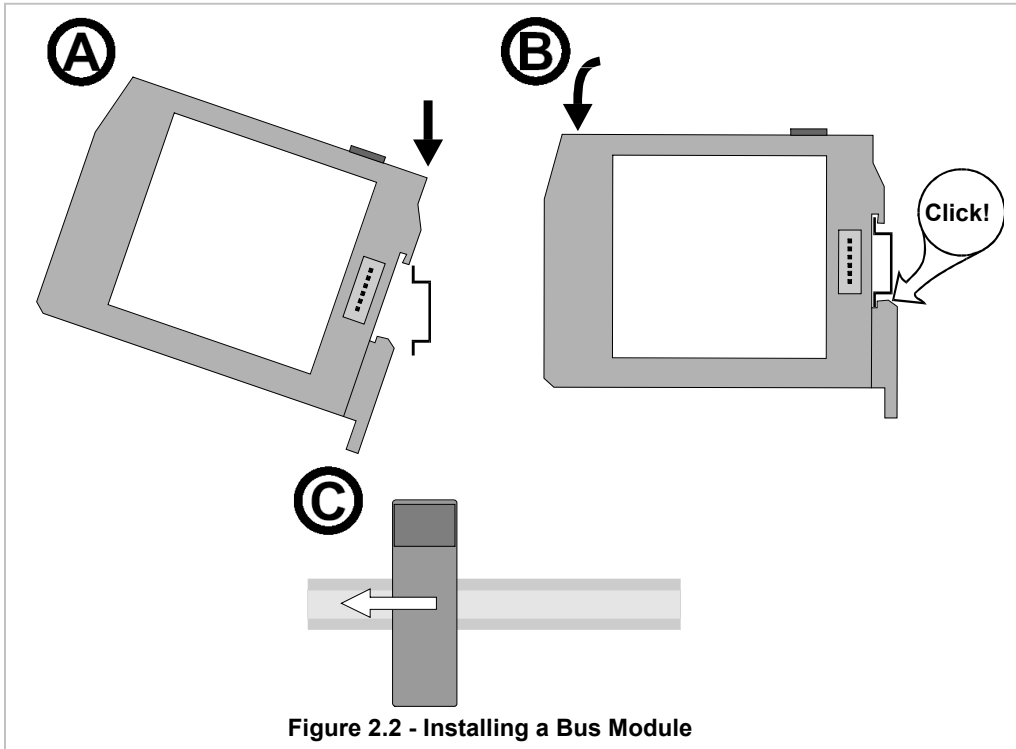

Figure 2.2 - Installing a Bus Module

2.3 Installing the Loop Modules and Interconnect Module

Ensure that the Loop Module is separated from the Interconnect Module. Install the Interconnect Module first:

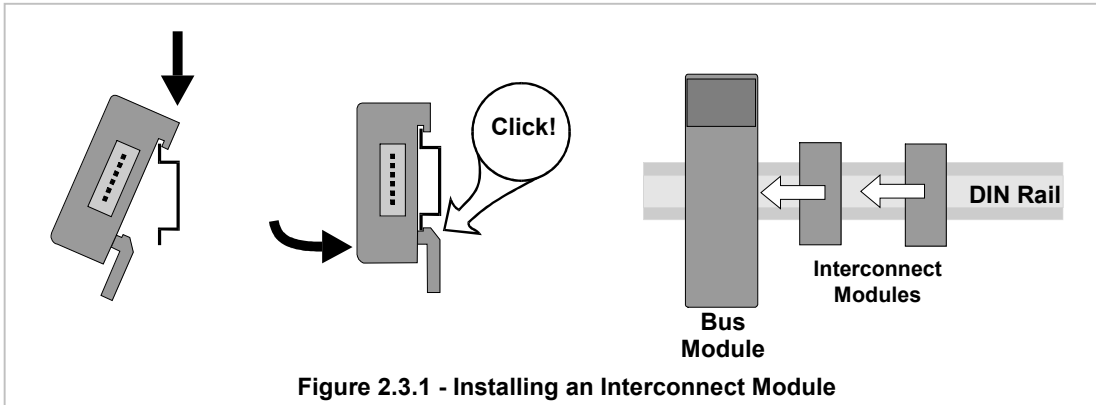

Figure 2.3.1 - Installing an Interconnect Module

Then install the Loop Module:

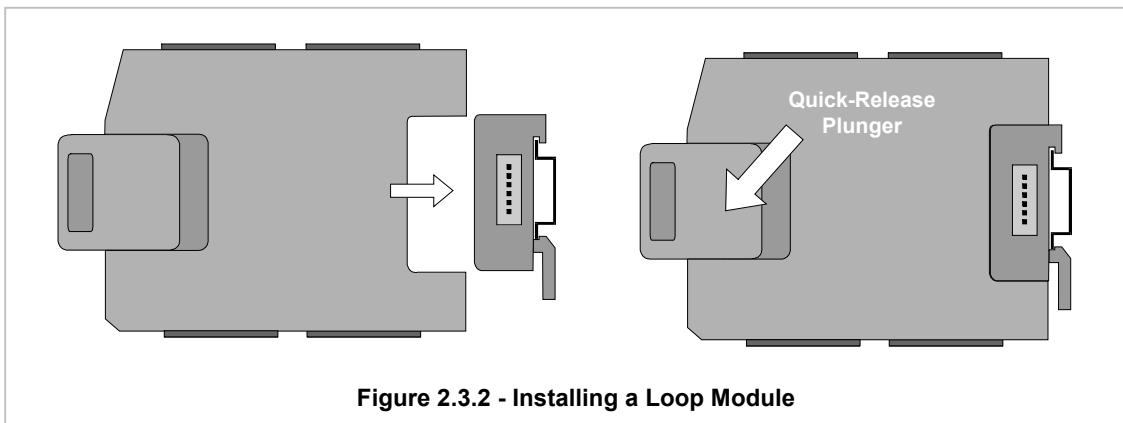
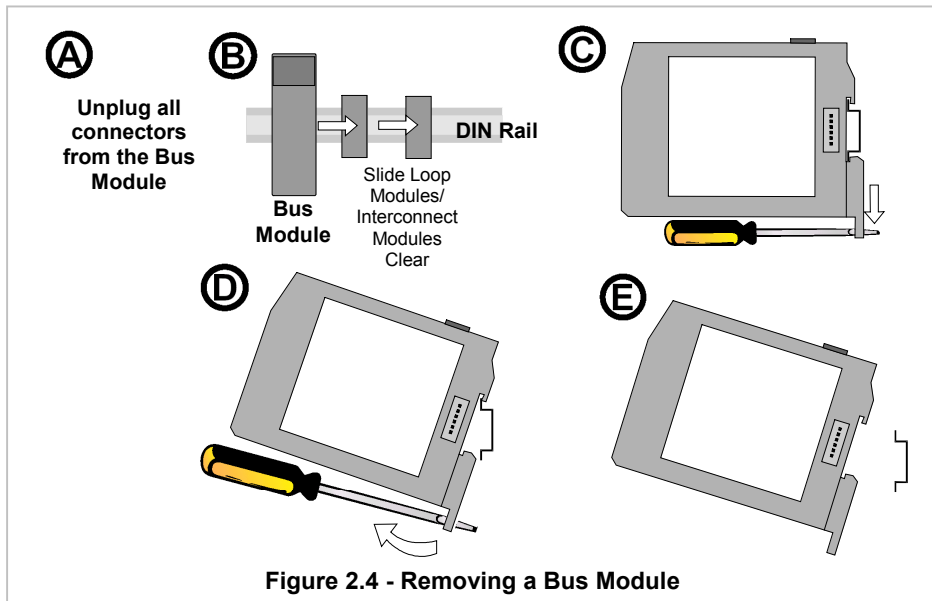

Figure 2.3.2 - Installing a Loop Module

2.4 Removing a Bus Module



CAUTION: Ensure that power has been removed from all equipment currently in the enclosure before removing the Bus Module.



2.5 Removing a Loop Module

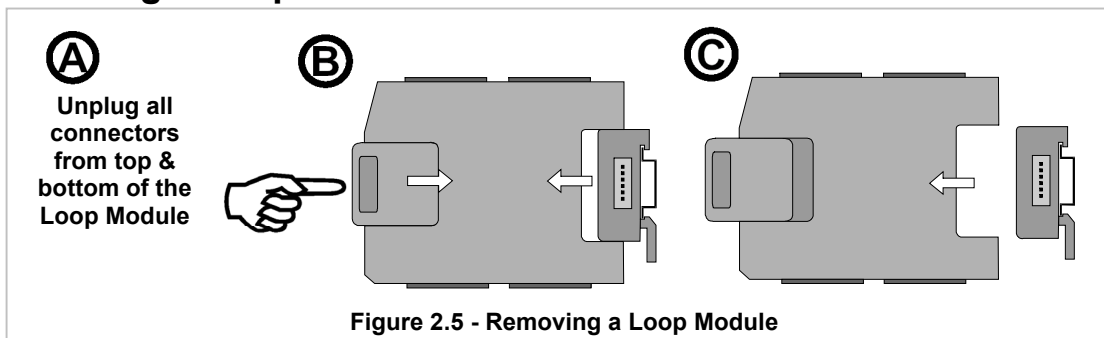

2.6 Removing an Interconnect Module

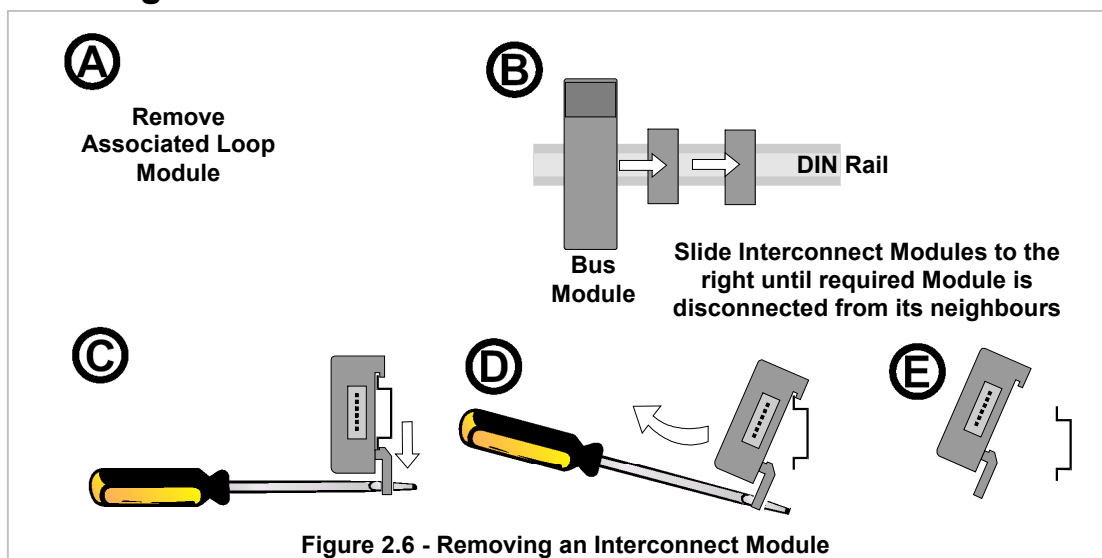

2.7 Precautions Whilst Wiring

Electrical noise is a phenomenon typical of industrial environments. As with any instrumentation, these guidelines should be followed to minimize the effect of noise.

2.7.1 Installation Considerations

Ignition transformers, arc welders, mechanical contact relays and solenoids are all common sources of electrical noise in an industrial environment and therefore the following guidelines MUST be followed.

1. If the instrument is being installed in existing equipment, the wiring in the area should be checked to ensure that good wiring practices have been followed.
2. Noise-generating devices such as those listed should be mounted in a separate enclosure. If this is not possible, separate them from the instrument, by the largest distance possible.
3. If possible, eliminate mechanical contact relays and replace with solid-state relays. If a mechanical relay being powered by an output from this instrument cannot be replaced, a solid-state relay can be used to isolate the instrument.
4. Allow sufficient free wiring (i.e. free of looming, wrapping or conduit) at the MLC 9000+ system end to permit movement of connectors and modules during module Installation/removal/replacement.

2.7.2 Wire Isolation

CAUTION: The only wires that should run together are those of the same category. Signal wires should run with signal wires and power cables should run with power cable

If any wires need to run parallel with any other lines, maintain a minimum space of 150mm between them. If wires MUST cross each other, ensure they do so at 90 degrees to minimise interference.

2.7.3 Use of Shielded Cable

All analogue signals must use shielded cable. This will help eliminate electrical noise induction on the wires. Connection lead length must be kept as short as possible keeping the wires protected by the shielding. The shield should be grounded at one end only. The preferred grounding location is at the sensor, transmitter or transducer.

2.7.4 Noise Suppression at Source

Usually when good wiring practices are followed, no further noise protection is necessary. Sometimes in severe electrical environments, the amount of noise is so great that it has to be suppressed at source. Many manufacturers of relays, contactors etc supply 'surge suppressors' which mount on the noise source. For those devices that do not have surge suppressors supplied, Resistance-Capacitance (RC) networks and/or Metal Oxide Varistors (MOV) may be added.

Inductive coils - MOVs are recommended for transient suppression in inductive coils, connected in parallel and as close as possible to the coil. Additional protection may be provided by adding an RC network across the MOV.

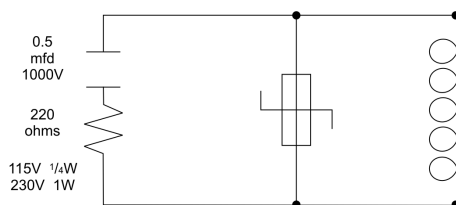

Figure 2.7.1 - Transient suppression with inductive coils

Contacts - Arcing may occur across contacts when they contact open and close. This results in electrical noise as well as damage to the contacts. Connecting a properly sized RC network can eliminate this arc. For circuits up to 3 amps, a combination of a 47 ohm resistor and 0.1 microfarad capacitor (1000 volts) is recommended. For circuits from 3 to 5 amps, connect two of these in parallel.

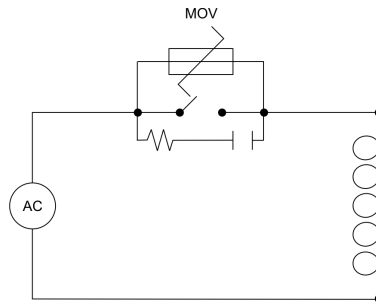

Figure 2.7.2 - Contact noise suppression

2.7.5 Sensor Placement (Thermocouple or RTD)

If the temperature probe is to be subjected to corrosive or abrasive conditions, it must be protected by an appropriate thermowell. The probe must be positioned to reflect true process temperature:

1. In a liquid media - the most agitated area
2. In air - the best circulated area

CAUTION: The placement of probes into pipe work some distance from the heating vessel leads to transport delay, which results in poor control.

For a two wire RTD a wire link should be used in place of the third wire. Two wire RTDs must only be used with lead lengths less than 3 meters. Use of three wire RTDs is strongly recommended.

2.8 Electrical Connections – Bus Module

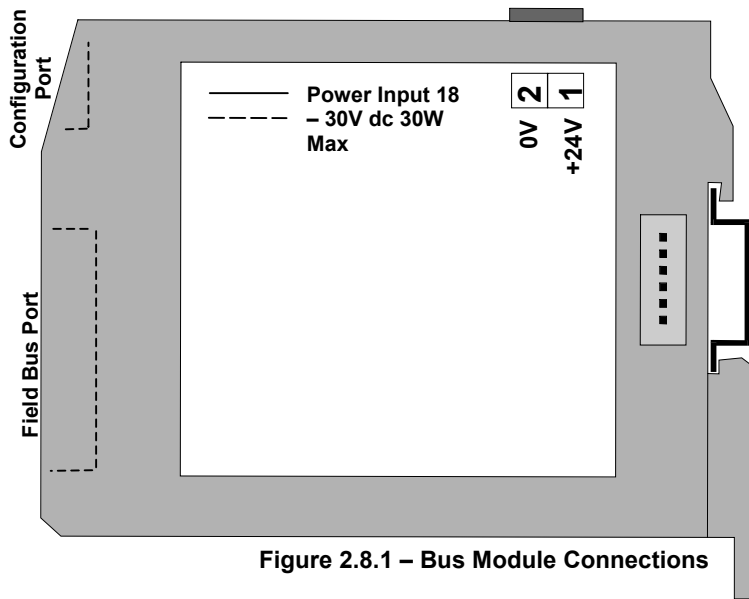

Figure 2.8.1 – Bus Module Connections

2.8.1 Power Input

The system requires a power input of 18 - 30V DC and has a maximum power consumption of 30W. It is recommended that the power supply is connected via a two-pole isolating switch (preferably situated near the System) and a 2A slow-blow fuse or a 2A Type C MCB (see Figure 2.8.2).

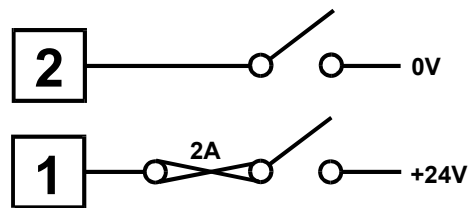
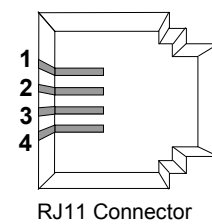

Figure 2.8.2 - Recommended Mode of Power Connection

2.8.2 Configuration Port

This connects the Bus Module to a local PC for configuration. The configuration port uses the point to point connection specification RS232. Pin connections are shown on the right. A cable is provided with the configuration software.

Pin No.	Signal / Function
1	Receive Data
2	Transmit Data
3	No connection
4	Signal Ground



2.8.3 FieldBus Port – RS485 MODBUS (BM220-MB only)

This connects the Bus Module to an RS485 network. Pin connections are shown on the right. The Common connection is provided for termination of the cable screen (shielded). Termination of the cable screen should be at one point in the RS485 network. The RS485 Bus Module can only be connected to a MODBUS RTU master.

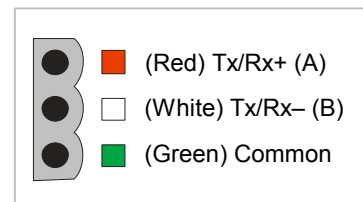

2.8.4 FieldBus Port – DeviceNet (BM230-DN)

When installed with the DeviceNet firmware (BM230-DN) the Bus Module can be connected to a DeviceNet enabled master device. DeviceNet compliant cables and connectors must be used when connecting to the network. DeviceNet networks must be terminated with 121ohm resistors between CAN_L and CAN_H at each physical end of the CAN network. A separate 24V power supply should be used to power the network between V+ and V-. Terminal connections are shown on the right.

The **SHIELD** connection is provided for termination of screened (shielded) cable.

Note: Most DeviceNet communication problems are caused by incorrect wiring and power supply selection. If any problems are encountered the DeviceNet website has guidelines on wiring a DeviceNet system. (www.odva.org)

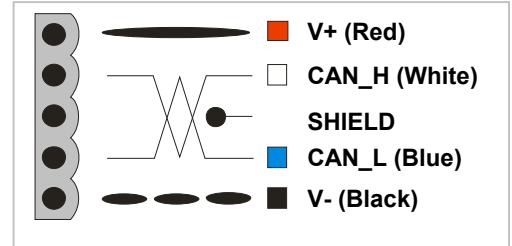

2.8.5 FieldBus Port – PROFIBUS-DP (BM240-PB only)

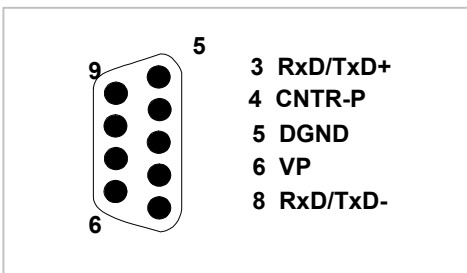

This enables the Bus Module to be connected to a PROFIBUS-DP master device (local operator interface/display, PLC or multi-drop PC operator and configuration network). PROFIBUS compliant cables and connectors must be used when connecting to a network. Pin connections are shown on the right. For more information on PROFIBUS consult the PROFIBUS website (www.profibus.com)

2.8.6 FieldBus Port – Ethernet/IP & MODBUS/TCP (BM250-EI or MT)

Both the Ethernet/IP and MODBUS/TCP fieldbus protocols use the same Ethernet standard. When installed with the Ethernet/IP firmware (BM250-EI) the Bus Module can be connected to an Ethernet/IP enabled master device. When installed with the MODBUS/TCP firmware (BM250-MT) the Bus Module can be connected to a MODBUS/TCP enabled master device. Both Ethernet/IP and MODBUS/TCP are connected to the Ethernet network via an RJ45 connector that conforms to CAT 5 cabling and 568A, 568B wiring sequences. Both B250 types support the 10/100BaseT Ethernet standards.

Pin No.	568A	568B
1	WHITE/green	WHITE/orange
2	GREEN/white	ORANGE/white
3	WHITE/orange	WHITE/green
4	BLUE/white	BLUE/white
5	WHITE/blue	WHITE/blue
6	ORANGE/white	GREEN/white
7	WHITE/brown	WHITE/brown
8	BROWN/white	BROWN/white

2.9 Electrical Connections – Loop Module



CAUTION: The system is designed for installation in an enclosure, which provides adequate protection against electric shock. Local regulations regarding electrical installation and safety should be rigidly observed. Consideration should be given to prevention of access to the power terminations by unauthorised personnel.

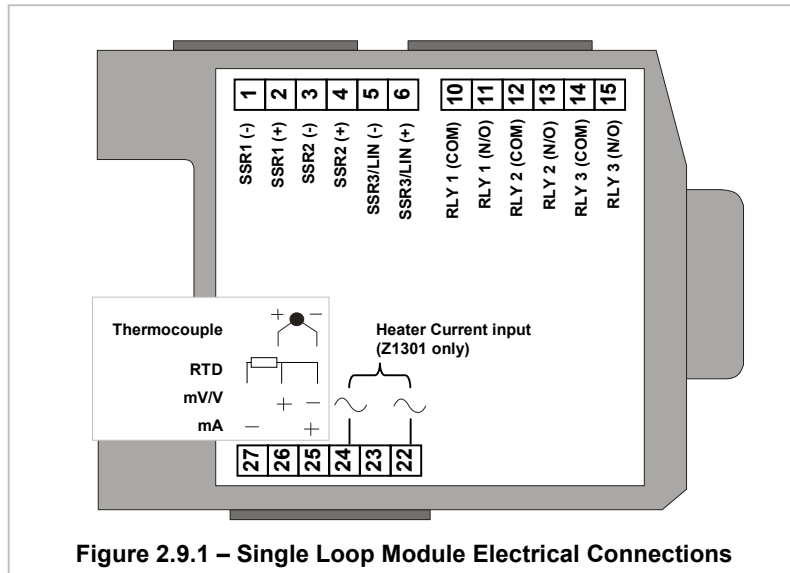

Figure 2.9.1 – Single Loop Module Electrical Connections

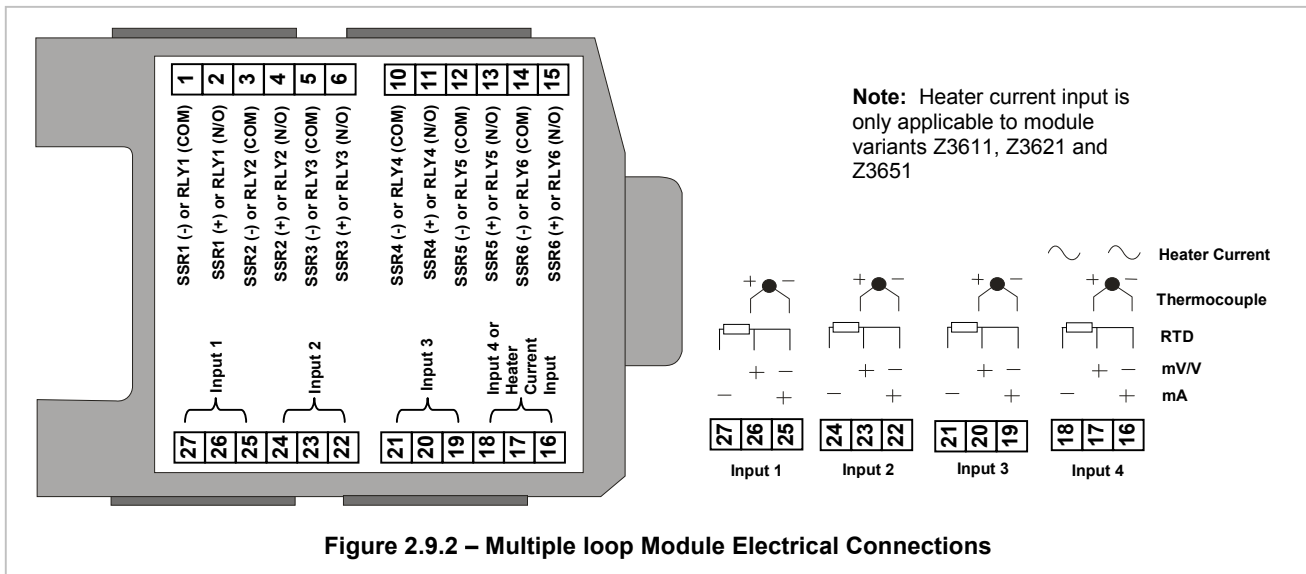

Figure 2.9.2 – Multiple loop Module Electrical Connections

Module Type	Outputs					
	1	2	3	4	5	6
Z3611	Relay	Relay	Relay	Relay	Relay	Relay
Z3621	SSR	SSR	SSR	SSR	SSR	SSR
Z3651	SSR	SSR	SSR	Relay	Relay	Relay
Z4610	Relay	Relay	Relay	Relay	Relay	Relay
Z4620	SSR	SSR	SSR	SSR	SSR	SSR
Z4660	SSR	SSR	SSR	SSR	Relay	Relay

Table 2.9 – Multi-loop module output type

2.9.1 Thermocouple Inputs

The correct type of extension leadwire/compensation cable must be used for the entire distance between the Loop Module connector and the thermocouple; correct polarity must be observed throughout and joints in the cable should be avoided. If the thermocouple is grounded, this must be done at one point only.

NOTE: Do not run thermocouple cables adjacent to power-carrying conductors. If the wiring is run in a conduit, use a separate conduit for the thermocouple wiring. If the thermocouple is grounded, this must be done at one point only. If the extension lead is shielded, the shield must be grounded at one point only.

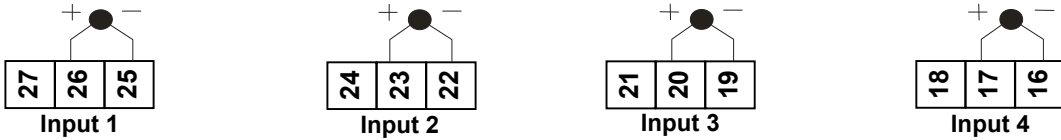

NOTE: Input 1 is always available, Inputs 2 and 3 applicable to all multiple loop modules, input 4 applicable only to Z4610, Z4620 and Z4660.

2.9.2 RTD Input (3-Wire)

The extension leads should be copper and the resistance of the wires connecting the resistance element should not exceed 50Ω per lead (the leads should be of equal resistance). For three wire RTDs, connect the resistive leg and the common legs of the RTD as illustrated. For a two wire RTD a wire link should be used in place of the third wire (shown by dotted line). Two wire RTDs should only be used when the leads are less than 3 meters long. Avoid cable joints.



NOTE: Input 1 is always available, Inputs 2 and 3 applicable to all multiple loop modules, input 4 applicable only to Z4610, Z4620 and Z4660.

2.9.3 Linear Inputs

Linear DC voltage, millivolt or milliamp input connections are made as illustrated. Carefully observe the polarity of the connections.

Volts and Millivolt inputs



Miliamp inputs



NOTE: Input 1 is always available, Inputs 2 and 3 applicable to all multiple loop modules, input 4 applicable only to Z4610, Z4620 and Z4660.

2.9.4 Single Loop Heater Current Input (Z1301)

For single loop modules with a heater current input the secondary of the current transformer (CT) should be connected to the input terminals of the Loop Module and the main heater conductor should be passed through it.

WARNING: The Heater Current input must not exceed 60mA.

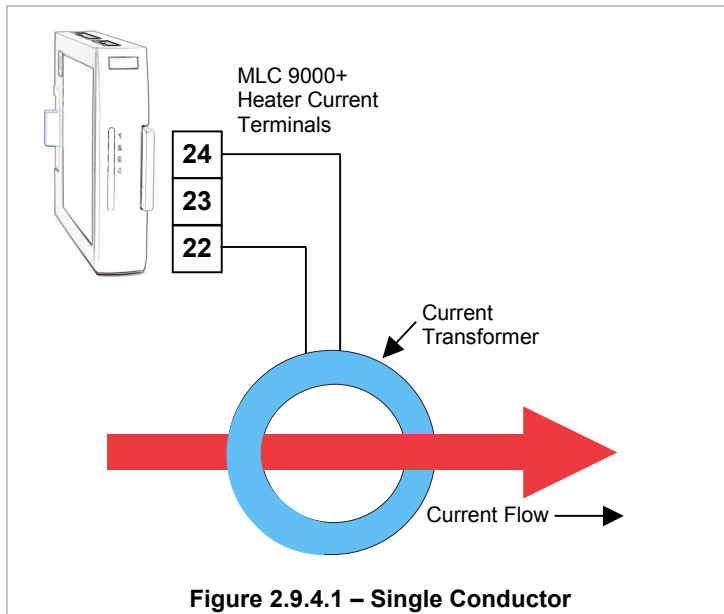

If the secondary current to the CT input of the controller is small, an accurate reading may not be possible. It is recommended that the CT input current be between 50% and 100% of the span of the input. If the heater current is less than 10% of the current transformers rating (e.g. 5A for a 50A CT) adequate detection can not be ensured. A method of making the current appear larger is to loop the heater load conductor through the CT more than once, this multiplies the perceived heater current by the number of times the conductor goes through the CT. e.g. if 3 loops are made the heater current will appear to be 3 times the actual.

The heater current high scale limit then needs to be scaled to take into account the multiplication factor of the looped conductor.

e.g. as the example above the heater current high scale value will need to be 3 times smaller than normally entered so for a 60A CT the heater high scale limit will be 20 amps.

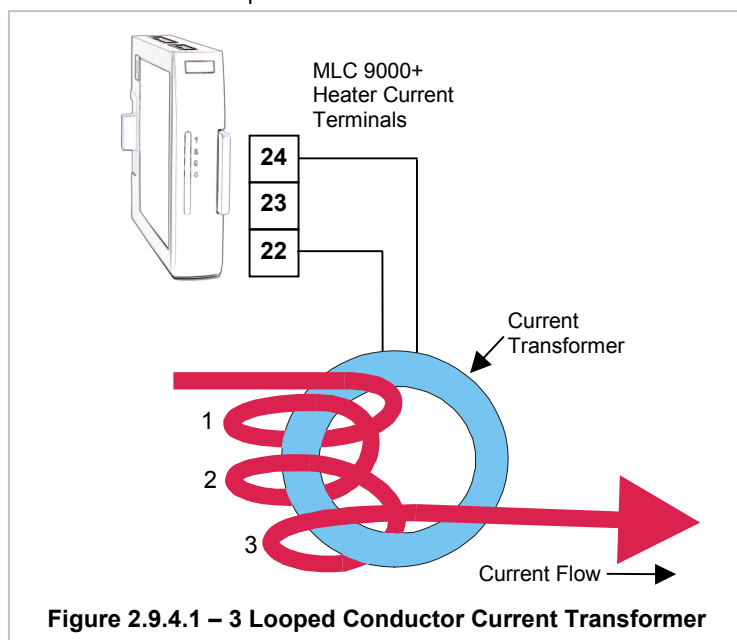

2.9.5 Multiple Loop Heater Current Input (Z3611, Z3621, Z3651)

Connection method 1:

For multiple loop modules with a heater current input a single CT is used. Each of the main heater conductors is passed through the single CT. The value of CT must be calculated to be able to withstand the maximum current in all three conductors at the same time.

For example: if the three heater conductors are 10A each then the current transformer needs to be rated at least 30A. (3 x 10A)

WARNING: The Heater Current input must not exceed 60mA

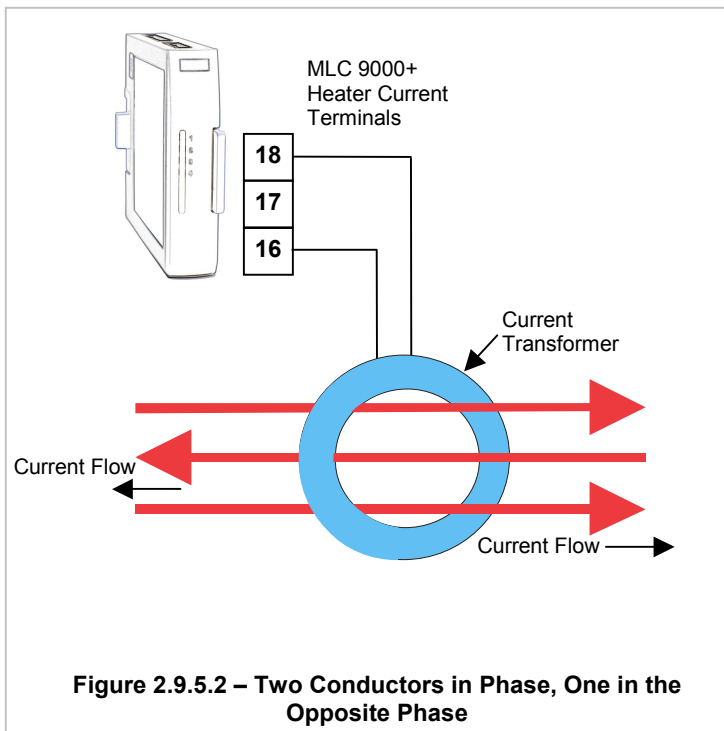
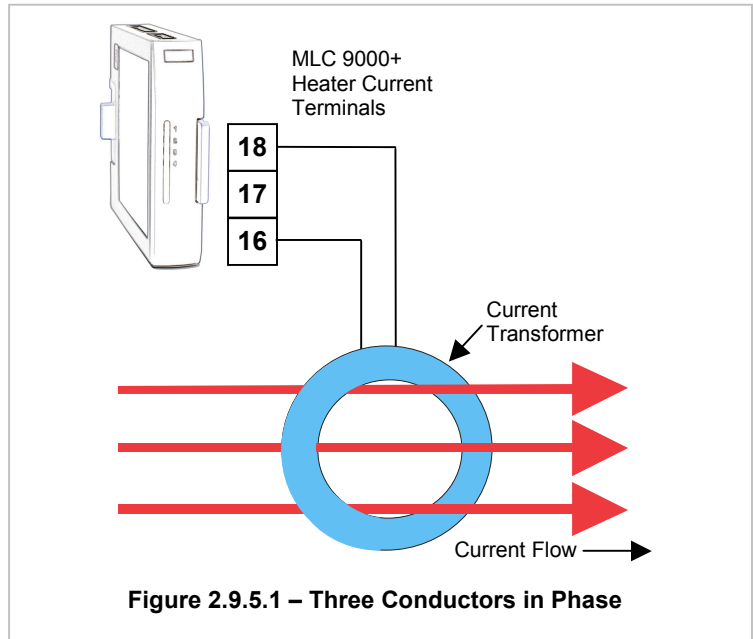

Connection Method 2:

If a CT can not be found that is of sufficient size or a higher resolution of current monitoring is required, one of the conductors can be passed through the CT in the opposite direction to the other two. This has the effect of cancelling out one of the others when all three are on and as such reducing the current transformer size requirement.

For example: With three Heater conductors rated at 50A each the maximum current through the CT would be 150A (3 x 50A), if one of the conductors is passed through the CT in the opposite direction the worst case would be that the conductor in the opposite direction is off and the other two are on giving a maximum current of 100A (2 x 50A)

This method of connection also has the effect of increasing the resolution of the heater current measurement compared to the method 1. When measuring a single conductor with method 1 the measured current is 1/3rd of the overall current rating of the current transformer where as with this method 1/2 of the current transformers range is being used to read the single conductor.

WARNING: The Heater Current input must not exceed 60mA

The current transformers available from your MLC 9000+ supplier are:

- | | |
|----------|-------------------|
| 25:0.05 | part number 85258 |
| 50:0.05 | part number 85259 |
| 100:0.05 | part number 85260 |

2.9.6 SSR Driver Outputs

The solid-state relay driver is a 0-12V DC signal (10V DC minimum) at up to 20mA, load impedance must be no less than 500 ohms. Not isolated from signal input or other SSR driver outputs.

- Note:**
1. Outputs available depend on Loop Module type.
 2. The SSR Driver is powered by the MLC 9000+ no external power supply is required.

Single-Loop modules

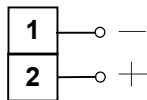

Output 1

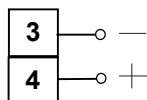

Output 2

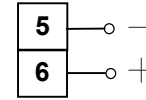

Output 3

Multiple-Loop modules

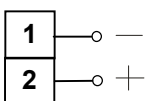

Output 1

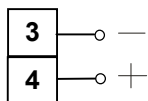

Output 2

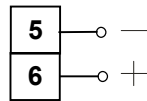

Output 3

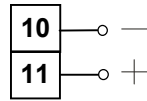

Output 4

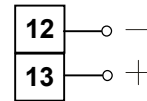

Output 5

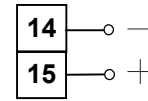

Output 6

2.9.7 Relay Outputs

The relay outputs are Single pole Single throw and are rated at 2A resistive 120/240VAC.

- Note:** Outputs available depend on Loop Module type

Single loop modules

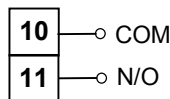

Output 1

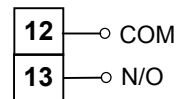

Output 2

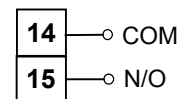

Output 3

Multiple loop modules

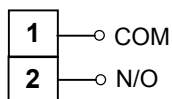

Output 1

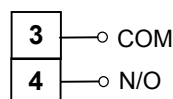

Output 2

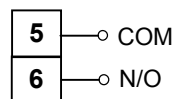

Output 3

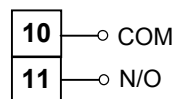

Output 4

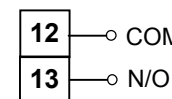

Output 5

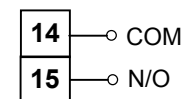

Output 6

2.9.8 Linear Output

The linear output is only available on the single loop modules Z1300, Z1301 and can be configured for mA or V.

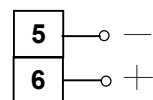

Output 3

- Note:** The Linear output is powered by the MLC 9000+ no external power supply is required.

3 GETTING STARTED

3.1 Installing MLC 9000+ Workshop

1. Insert the installation disk into the CD drive on your PC. The Set-up program should start automatically; If it does not, navigate to the appropriate drive using Windows Explorer and double click the Set-up icon.
2. The Set-up Wizard will guide you through the installation procedure.
3. You will be prompted to define a folder into which you want the software installed. You may use the default folder or specify one of your own choice.

3.2 Running MLC 9000+ Workshop

The first screen displayed on start-up is an options menu. This options menu gives you three choices:

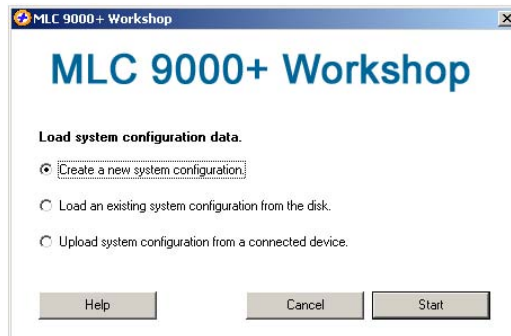

1. **Create a new System Configuration:** This option is for configuration of an MLC 9000+ system without the physical hardware being connected to the PC.
2. **Load an existing System Configuration from the disk:** This option loads a configuration that has already been saved previously.
3. **Upload System Configuration from a connected device:** This option gathers the system configuration information from an MLC 9000+ system that is connected to the RS 232 port of the PC.

To create a new configuration select 'Create a new System Configuration' and press Start, this will then take you to the system configuration screen. If the Bus Module is new and has never been configured this option must be selected as the Bus module will have no configuration.

To navigate through the different configuration screens of the MLC 9000+ Workshop software select View in the menu bar or use the buttons in the task bar.

3.3 System Configuration

The system configuration screen is used to define which Bus Module and Loop Modules are used in the MLC 9000+ system. The Left hand column is a list of all the Bus Module and Loop Module drivers available. The right hand column is a blank system. To insert a module into the system drag from the available modules in the left hand column and drop in an available slot in the right hand column. The first module to add is the Bus Module. Select a Bus Module type and drag and drop it into the Bus Module slot. The Loop modules can then be added in any order. When adding modules ensure that the physical hardware is installed in the same configuration. For example if the physical MLC 9000+ system is a BM230-DN Bus Module and three Z3611 Loop Modules the system configuration entered must be the same.

Once System Configuration is complete proceed to the Configuration Wizard using the View | Configuration wizards

menu option or by pressing the wizard button. 

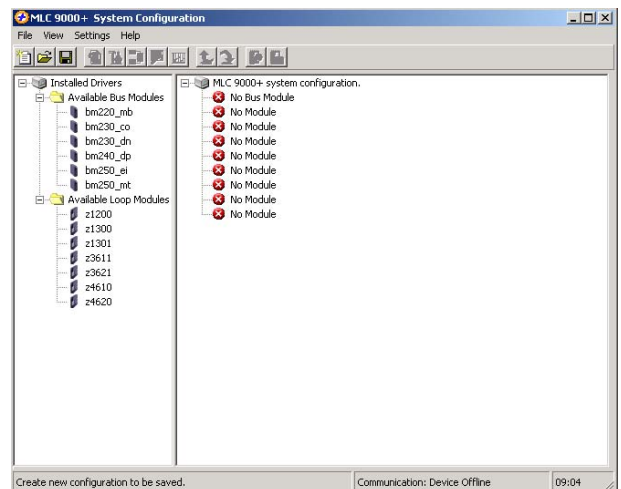

3.4 Configuration Wizards

The configuration wizard screen is used to configure the control characteristics of the Loop Modules and the standard communication parameters of the Bus Module. In the left hand column are all the modules that were added during System Configuration.

Click on the + sign next to the module. A list of the available configuration wizards is then displayed. To activate a wizard double click on the wizard name.

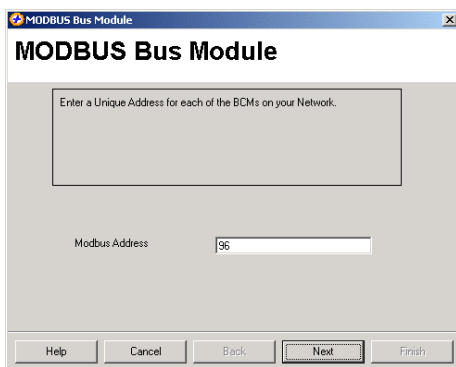
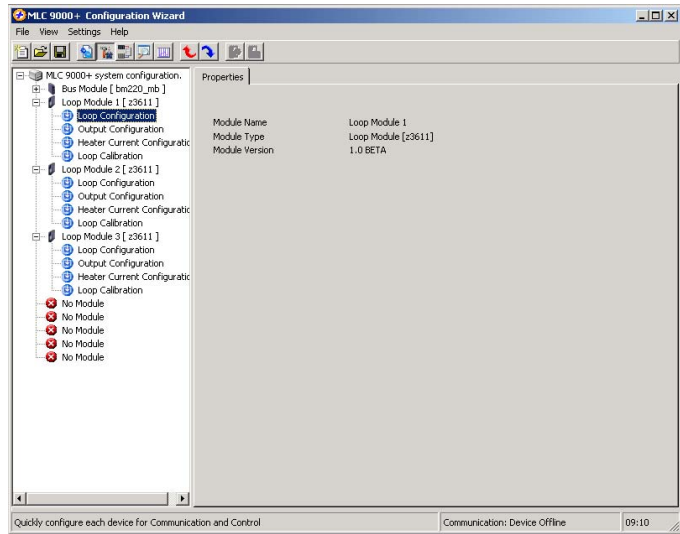

Each Bus Module type has a wizard that can be used to configure the communication parameters required for successful communication.

All Loop Modules have three common wizards:

1. **Loop Configuration:** This wizard is for configuration of the most common control loop parameters in the module.

For single loop controller modules (Z1200, Z1300, and Z1301) the loop configuration only gives you the option to configure a single loop.

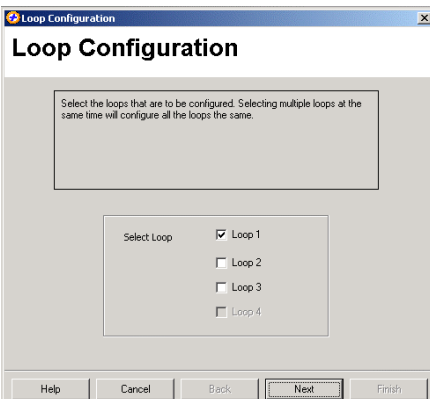
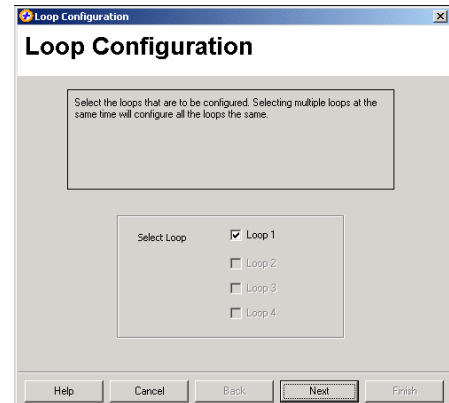

For multi-loop controller modules (Z3611, Z3621, Z3651, Z4610, Z4620 and Z4660) the loop configuration gives you the option to configure multiple loops with the same configuration at the same time. This then reduces the time required to configure multiple loops.

2. **Output Configuration:** This wizard is used to allocate the outputs to specific tasks and in the case of the multi-loop Modules which loop they will work with.

Any of the outputs in a single loop module can be assigned any task. For multiple loop modules each control loop needs to be assigned an output.

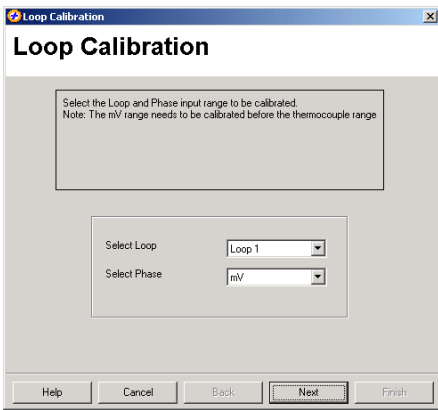
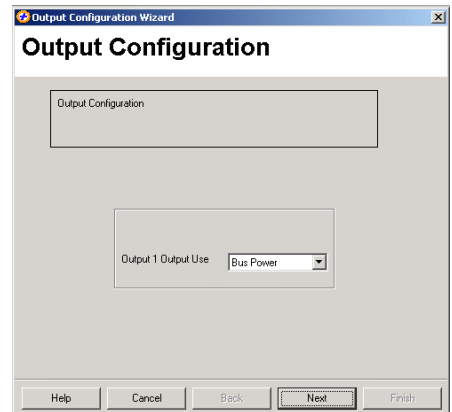

3. **Loop Calibration:** This wizard is for calibration of the inputs. It should only be used if you are sure that the input is out of calibration.

WARNING: Incorrect calibration will cause the MLC 9000+ to malfunction

For modules that have the Heater Current input (Z1301, Z3611, Z3621 and Z3651) there is a separate wizard

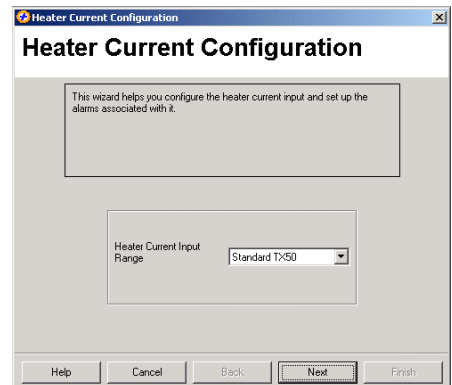

3.5 Configuring the Fieldbus Communications (Data Assemblies)

Select the Data Assemblies screen using View | Data Assemblies or the Data Assemblies button.  A Data Assembly is a user-defined collection of parameters that the Bus Module collects from its Loop Modules so that the master device (PLC, SCADA or HMI) can collect the required parameter data in one message transaction.

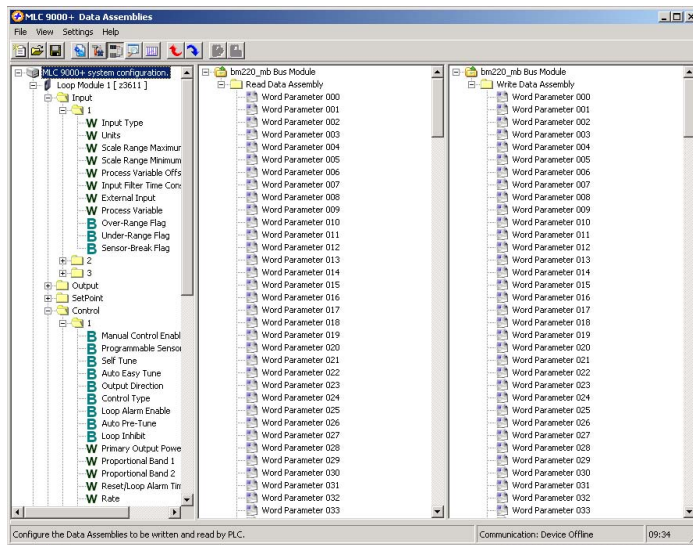

There are two user definable data assemblies. These are 1) **Read** - parameters that are to be transferred from the MLC 9000+ to the supervisory system and 2) **Write** - parameters that are to be transferred from the supervisory system to the MLC 9000+.

In the left hand column are all the parameters that can be mapped to the data assemblies for transfer to or from the supervisory system and on the right are the two data assemblies. To populate the data assemblies select a parameter from the list then drag and drop it into the read or write tables. MLC 9000+ will not allow read only parameters to be placed into the write data assembly.

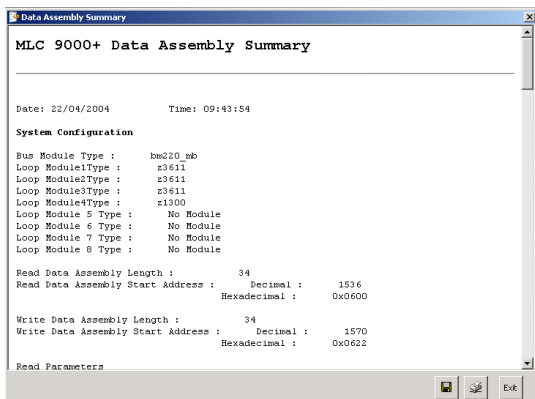
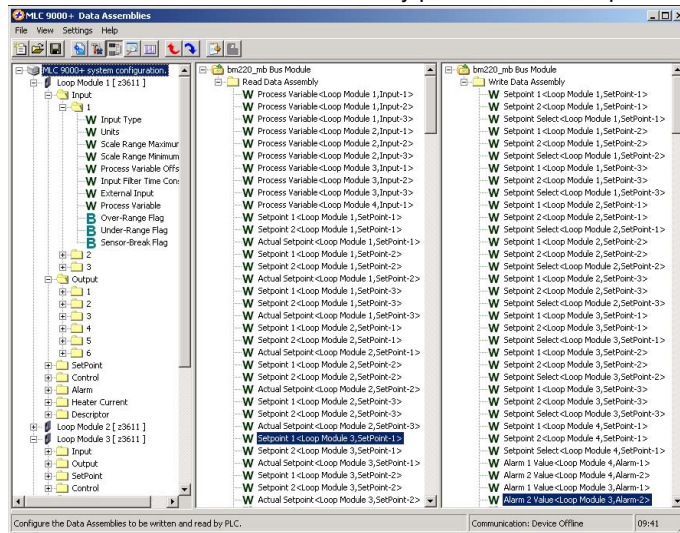

Word parameters are shown with a **W** and bit parameters are shown with a **B**. If a bit parameter is dragged onto a word register the register is converted into 16 bits. The full 16 bits can then be filled with any combination of bit parameters. If a word parameter is placed into that bit register then it is then converted back to a word register and the bit configuration is lost.

A summary of the data assembly information can be created by selecting the 'summary' icon  in the tool bar

3.6 Saving a System Configuration

Once the system has been configured it can be saved by clicking on the save  icon in the tool bar or navigate to File | Save as.

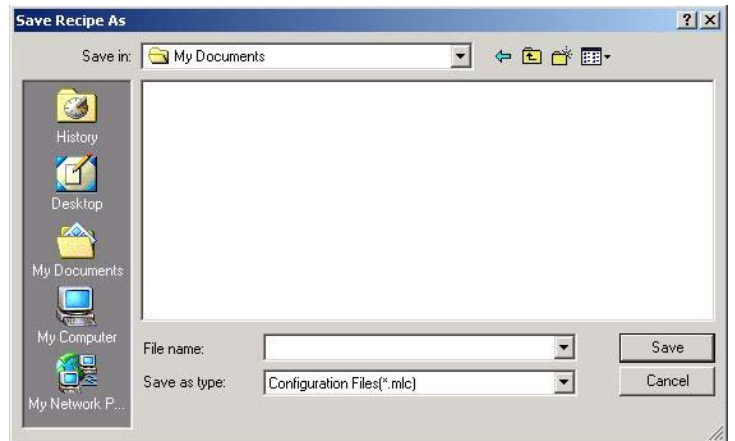

3.7 Generating the GSD/EDS file

Some Fieldbus protocols require a GSD/EDS file for configuration of the master device. MLC 9000+ Workshop generates this file once the data assemblies have been populated. Click on the create GSD/EDS icon  in the tool bar this will activate the create GSD/EDS wizard that will guide you through the creation of the GSD/EDS file.

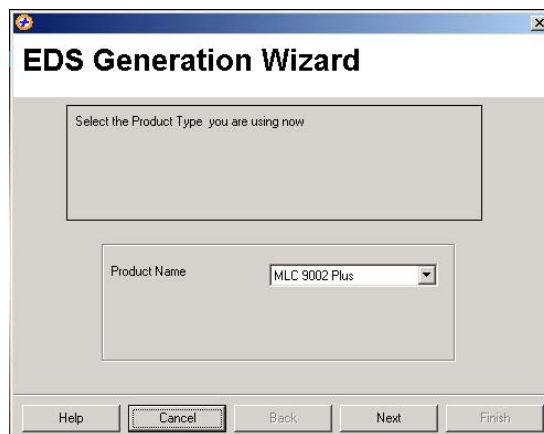

3.8 Downloading the Configuration to the MLC 9000+

To download the configuration to the MLC 9000+ click on the  icon in the tool bar, this will activate the download wizard which will guide you through the download process.

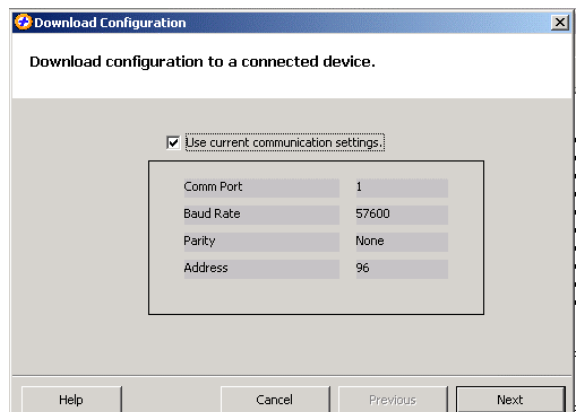

3.9 Adjusting and Monitoring a Live system

The MLC 9000+ system can be adjusted using the expert view and monitored using the Monitoring view.

Adjusting Parameters in Expert view

The expert view contains all the parameters that can be edited in a full system.

In the left hand column are the modules as configured in the system configuration, by clicking on the + sign next to the module the tree view is expanded and all the parameter classes are displayed.

When a class is selected all the parameters for that class are displayed on the right. Clicking on the value of a parameter enables that parameter to be edited. When all required parameter changes have been made the configuration can be download to the MLC 9000+ by clicking on the Download configuration icon.

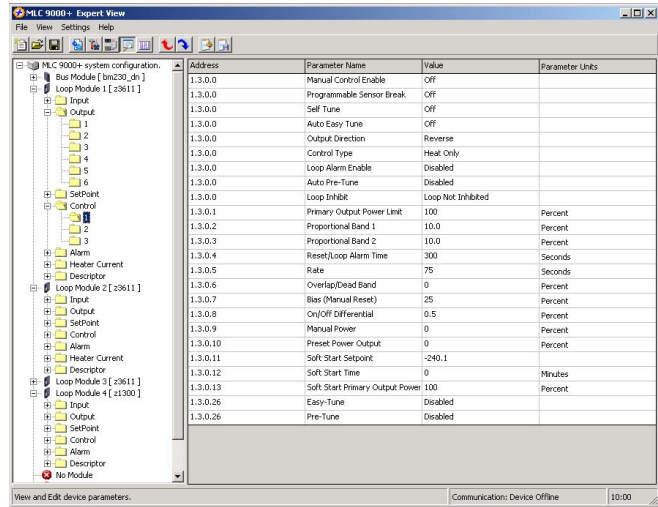

To work online select Settings | Work Online. This will then make the expert view live so that any changes made will be downloaded to the MLC 9000+ **immediately**.

WARNING: Care must be taken when working online as changing certain parameters may cause others to change automatically (i.e. when the input range is changed the scaling is defaulted)

CAUTION: When working online it is advised that steps are taken to ensure damaging conditions can not be caused.

Monitoring View

In the left hand column are all the parameters that can be viewed, organised by module and class. To monitor a variable double click the parameter name. It will then appear in the right hand column.

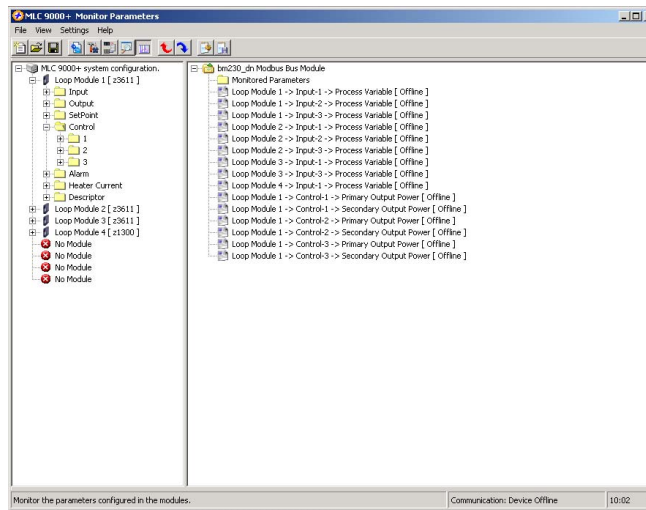

4 PARAMETER DESCRIPTIONS

In the following Subsections, each parameter's function and its adjustment range are described. All values are in decimal form unless otherwise stated. Where hexadecimal values are used they are expressed as 0x00. A brief statement of the inter-dependency with other parameters is also included. Parameters available are dependent on Loop Module variant.

4.1 Input Parameters

These parameters relate to the process inputs for the Loop Controller Modules.

4.1.1 Process Variable (PV) Value

This parameter is the current process variable value (= Measured PV + PV Offset). It is in the range (Scale Range Minimum – 5% of span) to (Scale Range Maximum + 5% of span).

4.1.2 Input Filter Time Constant

An adjustable low pass filter to reduce extraneous noise on the process input value. This value should be set to as small a value as possible while still eliminating non process change fluctuations. The default setting is usually sufficient.

Adjustment Range:	0.0 secs. or OFF (0x00), 0.5 secs. (0x01), 1.0 secs. (0x02) ⇒⇒⇒ 100.0 secs. (0xC8) in 0.5-second increments.
Default Value:	2.0 secs. (0x04)
Automatic Changes:	None
Effect of Change on Other Parameters:	None.

4.1.3 Process Variable Offset

This parameter is used to modify the measured process variable. Use this parameter only when necessary to compensate for an error in the process variable reading. Positive values are added to the process variable reading, negative values are subtracted. This parameter MUST be used with care, because adjustment of this parameter is in effect, a calibration adjustment. Injudicious application of values to this parameter could lead to the measured process variable value having no meaningful relationship to the actual process variable value.

Adjustment Range:	–(input span) to +(input span).
Default Value:	0

Warning: Changes to this value effect the calibration of the input.

Automatic Changes:	This parameter is set automatically to its default value if the Input Range is changed or if a change in Input Scale Range Maximum or Input Scale Range Minimum forces this parameter out of range. The units for this parameter are changed automatically if the Input Units are changed.
Effect of Change on Other Parameters:	None.

4.1.4 Over-range Flag

This parameter indicates whether the Process Variable Value is greater than the Input Scale Range Maximum Value. A '1' indicates a PV > Input Scale Range Maximum and a '0' indicates a PV ≤ Input Scale Range Maximum.

4.1.5 Under-range Flag

This parameter indicates whether the Process Variable Value is less than the Input Scale Range Minimum Value. A '1' indicates a PV < Input Scale Range Minimum and a '0' indicates a PV ≥ Input Scale Range Minimum.

4.1.6 Sensor Break Flag

This parameter indicates the presence/absence of a Sensor Break condition. (0 = no Sensor Break, 1 = Sensor Break).

4.1.7 Input Range (Type / Span)

This parameter defines the type and maximum scalable span of the input(s).

Input types available:	1 - "B" T/C (100 - 1824°C) (212 - 3315°F) 4 - "E" T/C (-250 - 999°C) (-418 - 1830 °F) 7 - "J" T/C (-200.1 - 1200.3°C) (-328.2 - 2192.5°F) 8 - "K" T/C (-240.1 - 1372.9°C) (-400.2 - 2503.2°F) 9 - "L" T/C (-0.1 - 761.4°C) (31.8 - 1402.5°F) 11 - "N" T/C (0.0 - 1399.6°C) (32.0 - 2551.3°F) 13 - "R" T/C (0 - 1759°C) (32 - 3198°F) 14 - "S" T/C (0 - 1759°C) (32 - 3198°F) 15 - "T" T/C (-240.0 - 400.5°C) (-400.0 - 752.9°F)	25 - PT100 (-199.9 - 800.3°C) (-327.3 - 1472.5°F) 30 - NI120 (-80.0 - 240.0 °C) (-112.0 - 464.0 °F) 32 - DC Linear 0 - 50mV 33 - DC Linear 10 - 50mV 40 - DC Linear 0 - 5V 41 - DC Linear 1 - 5V 42 - DC Linear 0 - 10V 43 - DC Linear 2 - 10V 48 - DC Linear 0 - 20mA 49 - DC Linear 4 - 20mA 63 - External Input
Default:	8 ("K" type thermocouple)	
Effects of change on other parameters:	A change to this parameter causes the following parameters to be forced to their default values: Input Scale Range Max. & Input Scale Range Min. Process Variable Offset External Input Value Proportional Band 1 & Proportional Band 2 Rate Reset Bias ON/OFF Differential Overlap/Deadband All setpoints (if forced out of range) Alarm values (if forced out of range) Alarm hysteresis values (if forced out of range)	

4.1.8 Input Units

This parameter defines the temperature units (0 = °C, 1 = °F) for thermocouple and RTD inputs. If the input is not a thermocouple or RTD type, reading this parameter will return an indeterminate value.

NOTE: This is a configuration parameter. It is not recommended that it is changed during operation, owing to repercussions on other parameters. Unit conversions should be handled by the external user interface.

Adjustment Range:	0 (°C) or 1 (°F).
Default Value:	0 (Europe) or 1 (USA)

4.1.9 Input Scale Range Maximum

This parameter is used to define the maximum input value for the selected input range. For Thermocouple and RTD inputs, this is a range trim facility which permits proportional band-related parameters to be adjusted for a smaller input range. For DC linear inputs this is used to define the maximum range of scale.

- Adjustment Range:** For DC linear inputs, adjustment range is -32000 (0x8300) to $+32000$ (0x7D00); minimum span = 1. This parameter can be greater than or less than, but not equal to, Input Scale Range Minimum. To reverse the input sense the parameter can be set lower than the Input Scale Range Minimum.
- For Thermocouple and RTD inputs, adjustment range is Input Scale Range Minimum + 100 LSDs to input range maximum.
- For an External Input, the adjustment range is -32768 (0x8000) to $+32767$ (0x7FFF).

NOTE: Input span is defined as the difference between Input Scale Range Maximum and Input Scale Range Minimum.

- Default Value:** Input range maximum (temperature range) or 1000 (DC linear range).
- Automatic Changes:** This parameter is automatically set to its default value if the Input Range is changed. The units for this parameter are changed automatically if the Input Units are changed.
- Effects of Change on Other Parameters:** When this parameter value is changed, the following parameters, if forced out of range, will be automatically set to their default values:
- Process Variable Offset
 - Setpoints (including soft start)
 - Alarm values
 - Alarm hysteresis values

4.1.10 Input Scale Range Minimum

This parameter is used to define the minimum input value for the selected input range. For Thermocouple and RTD inputs, this is a range trim facility that permits proportional band-related parameters to be adjusted for a smaller input range. For DC linear input ranges this is used to define the minimum range of scale.

- Adjustment Range:** For DC Linear Inputs, adjustment range is -32000 (0x8300) to $+32000$ (0x7D00); Minimum span = 1. This parameter can be greater than or less than, but not equal to, Input Scale Range Maximum. To reverse the input sense the parameter can be set greater than the Input Scale Range Maximum.
- For Thermocouple or RTD inputs, adjustment range is input range minimum to Input Scale Range Maximum - 100 LSDs.
- For an External Input, adjustment range is -32768 (0x8000) to $+32767$ (0x7FFF).
- Default Value:** Input range minimum (temperature range) or 0 (DC Linear range).
- Automatic Changes:** This parameter is automatically set to its default value if the Input Range is changed. The units for this parameter are changed automatically if the Input Units are changed.
- Effects of Change on Other Parameters:** When this parameter value is changed, the following parameters, if forced out of range, will be automatically set to their default values:
- Process Variable Offset
 - Setpoints (including soft start)
 - Alarm values
 - Alarm hysteresis values

4.1.11 External Input Value

This is the input range for the optional input source from Fieldbus (selected by the Input Range parameter). This input receives a directly-written input range value from an external device.

- Adjustment Range:** -32768 (0x8000) to +32767 (0x7FFF)
- Default Value:** Input Scale Range Maximum.
- Automatic Changes:** This parameter is automatically set to its default value if the Input Range is changed.
- Effect of Change on Other Parameters:** None.

4.2 Output Parameters

These parameters relate to the selection of output source and type of the Loop Controller Module.

4.2.1 Output Type

This parameter defines/indicates the output type.

- Available types:**

0 - Relay	3 - DC Linear 0 - 10V
1 - SSR Drive	4 - DC Linear 4 - 20mA
2 - DC Linear 0 - 20mA	5 - DC Linear 0 - 5V

Note: DC Linear settings are available on single loop Modules with Linear outputs on Output 3 only.
- Default Value:**

Module variants Z1200, Z1300, Z1301, Z3611 and Z4610 have a default output setting of 0 (Relay)

Module variants Z3621 and Z4620 have a default output setting of 1 (SSR Drive)

Module variant Z3651 outputs 1 to 3 have a default output setting of 1 (SSR Drive) and outputs 4 to 6 a default output setting of 0 (Relay)

Module variant Z4660 outputs 1 to 4 have a default output setting of 1 (SSR Drive) and outputs 5 and 6 a default output setting of 0 (Relay)
- Automatic Changes:** None.
- Effect of Change on Other Parameters:** If Output Type is changed from SSR Drive/Relay to DC Linear and Output Usage is not Primary Output nor Secondary Output, Output Usage is changed to Retransmit Output (SP). If Output Type is changed from DC Linear to SSR Drive/Relay, Output Cycle Time is set to its default value and, if Output Usage is initially Retransmit Output (SP or PV), Output Usage is changed to Alarm 1 Direct-acting.

4.2.2 Alarm Output Definition 1 to 4

With the output usage parameter set to Alarm (03 or 04) this parameter determines which alarms are to OR'd together to activate the output. In each output instance there are four instances of this parameter (one for each loop).

Bit	7	6	5	4	3	2	1	0
Alarm	Not Used	Not used	Heater Break Short Circuit Alarm	Heater Break High Alarm	Heater Break Low Alarm	Loop Alarm	Alarm 2	Alarm 1

- Default Value:** 0 (no alarms defined)
- Automatic Change:** None
- Effect of Change on Other Parameters:** None

4.2.3 Output Usage

This parameter defines what the output is to be used for.

Available Uses:	00 - Primary Control output 01 - Secondary Control output 02 - Bus Power output 03 - Alarm, direct-acting (Relay/SSR only) 04 - Alarm, reverse-acting (Relay/SSR only) 05 - Reserved 06 - Reserved 07 - Retransmit Output Setpoint (Linear only) 08 - Retransmit Output Process Variable (Linear only)																				
Default Values:	<table> <tr> <td>Single-Loop Modules</td> <td></td> </tr> <tr> <td> Output 1</td> <td>00 (Primary Control) output</td> </tr> <tr> <td> Output 2</td> <td>03 (Alarm, direct-acting)</td> </tr> <tr> <td> Output 3</td> <td>03 (Alarm, direct-acting)</td> </tr> <tr> <td>Three-Loop Modules</td> <td></td> </tr> <tr> <td> Outputs 1, 2, 3</td> <td>02 (Bus Power output)</td> </tr> <tr> <td> Outputs 4, 5, 6</td> <td>03 (Alarm, direct-acting)</td> </tr> <tr> <td>Four-Loop Modules</td> <td></td> </tr> <tr> <td> Outputs 1, 2, 3, 4</td> <td>02 (Bus Power output)</td> </tr> <tr> <td> Outputs 5, 6</td> <td>03 (Alarm, direct-acting)</td> </tr> </table>	Single-Loop Modules		Output 1	00 (Primary Control) output	Output 2	03 (Alarm, direct-acting)	Output 3	03 (Alarm, direct-acting)	Three-Loop Modules		Outputs 1, 2, 3	02 (Bus Power output)	Outputs 4, 5, 6	03 (Alarm, direct-acting)	Four-Loop Modules		Outputs 1, 2, 3, 4	02 (Bus Power output)	Outputs 5, 6	03 (Alarm, direct-acting)
Single-Loop Modules																					
Output 1	00 (Primary Control) output																				
Output 2	03 (Alarm, direct-acting)																				
Output 3	03 (Alarm, direct-acting)																				
Three-Loop Modules																					
Outputs 1, 2, 3	02 (Bus Power output)																				
Outputs 4, 5, 6	03 (Alarm, direct-acting)																				
Four-Loop Modules																					
Outputs 1, 2, 3, 4	02 (Bus Power output)																				
Outputs 5, 6	03 (Alarm, direct-acting)																				
Automatic Change:	None																				
Effects of Change on Other Parameters:	None																				

4.2.4 Output Cycle Time

This parameter defines the sum of the ON and OFF time for a time proportioned control output with a proportional band greater than 0.

Adjustment Range:	0 = 0.1 secs.	7 = 16 secs.
	1 = 0.25 secs.	8 = 32 secs.
	2 = 0.5 secs.	9 = 64 secs.
	3 = 1 sec.	10 = 128 secs.
	4 = 2 secs.	11 = 256 secs.
	5 = 4 secs.	12 = 512 secs.
	6 = 8 secs.	

The 0.1-second and 0.25-second settings are not available for relay outputs.

NOTE: This parameter is ignored if Proportional Band for this output is set to 0 (ON/OFF control) or if this output is a linear output or alarm output.

Default Value:	8 = 32 secs.
Automatic Change:	If the Output Type is changed from DC Linear to Relay/SSR Drive, this parameter is forced to its default setting.
Effects of Change on Other Parameters:	None

4.2.5 Output State

This bit parameter indicates when the output is active. 0 = output off, 1 = output on.

Note: This parameter is available on loop modules with firmware version 1.0.1 and above only.

4.2.6 Output Loop

This parameter defines the loop this output is assigned to.

4.2.7 DC Linear Output Scale Maximum (Modules Z1300 and Z1301 only)

This parameter is only applicable to DC linear outputs when Output Usage is set to Retransmit Output (SP or PV). The parameter defines the setpoint/process variable value (as appropriate) which corresponds to the maximum output value.

Adjustment Range:	–32768 (0x8000) to +32767 (0x7FFF).
Default Value:	+10000 (0x2710).
Automatic Change:	Units are converted automatically when the Input Units are changed.
Effects of Change on Other Parameters:	None

4.2.8 DC Linear Output Scale Minimum (Modules Z1300 and Z1301 only)

This parameter is only applicable to DC linear outputs when Output Usage is set to Retransmit Output (SP or PV). The parameter defines the setpoint/process variable value (as appropriate) which corresponds to the minimum output value.

Adjustment Range:	–32768 (0x8000) to +32767 (0x7FFF).
Default Value:	0.
Automatic Change:	Units are converted automatically when the Input units are changed.
Effects of Change on Other Parameters:	None.

4.2.9 Bus Power

This parameter determines the Bus Control value for the associated output. It is applicable only if the Output Usage for that output has been set to Bus Power.

A Bus Power Output is configured when there is a continuous requirement for manual control of the power level at that output. When a control output's usage is configured to be Bus Power, the third party device (human-machine interface, SCADA system etc.) may be used to set an output power value at that specific output (in the range 0% to +100%).

NOTES:

1. If a dual output (i.e. Primary output and Secondary output) control loop has the usage for both control outputs set to Bus Power, it is possible to apply power to both outputs simultaneously.
2. If a power failure or power-down occurs on a control loop with a Bus Power output, the output power setting is not saved; the output power is reset to 0% when power is restored, in preparation for receiving new values from the third party device.

Adjustment Range:	0% (0x00) to 100% (0x64).
Default Value:	0% (0x00)
Automatic Change:	None
Effects of Change on Other Parameters:	None

4.3 Setpoint Parameters

4.3.1 Setpoint 1

This parameter defines the value of Setpoint 1.

Adjustment Range:	Input Scale Range Minimum to Input Scale Range Maximum.
Default Value:	Input Scale Range Minimum.
Automatic Change:	This parameter is automatically set to its default value if forced out of range by a change to the Input Range, Input Scale Range Maximum or Input Scale Range Minimum. The units for this parameter change automatically if the Input Units are changed.
Effects of Change on Other Parameters:	Modifies Actual Setpoint value according to the actual setpoint calculation and the setting of Setpoint Select.

4.3.2 Setpoint 2

This parameter defines the value of Setpoint 2.

Adjustment Range:	Input Scale Range Minimum to Input Scale Range Maximum.
Default Value:	Input Scale Range Minimum.
Automatic Change:	This parameter is automatically set to its default value if forced out of range by a change to the Input Range, Input Scale Range Maximum or Input Scale Range Minimum. The units for this parameter are changed automatically if the Input Units are changed.
Effects of Change on Other Parameters:	Modifies Actual Setpoint value according to the actual setpoint calculation and the setting of Setpoint Select.

4.3.3 Setpoint Select

This parameter selects the active setpoint.

Adjustment Range:	01(Setpoint 1)	02 (Setpoint 2).
Default Value:	1 (Setpoint 1)	

4.3.4 Actual Setpoint

This parameter indicates the current value of the active setpoint. If setpoint 1 is selected this value equals the setpoint 1 value, if setpoint 2 is selected this value equals the setpoint 2 value. When the setpoint is ramping, this is calculated from the setpoint value at the start of the ramp and the setpoint ramp rate. If setpoint ramping is OFF, this parameter will always be equal to the selected setpoint.

NOTE: When the actual setpoint is ramping and the user selects Manual Control Mode, the ramp is suspended and the actual setpoint is set to be equal to the current process variable. This is in order that the ramp will resume from the process variable value when exiting from Manual Control Mode. This eliminates the possibility of increasing the manual power (increasing the process variable) then exiting from Manual Control Mode, causing the process variable to fall back to follow the setpoint ramp.

4.3.5 Setpoint Ramp Rate

This parameter defines the setpoint ramp rate in units/hour.

Adjustment Range:	1 (0x0001) to 9999 (0x270F) and OFF (0x0000).
Default Value:	OFF (0x0000)
Automatic Change:	None.
Effects of Change on Other Parameters:	If this parameter value is changed, the Actual Setpoint value is modified according to the Actual Setpoint calculation.

4.4 Control Parameters

4.4.1 Control Bits

This parameter is a combination of the bit parameters in the Control Class. The configuration is:

Bit	Parameter Name	Page Index
0	Manual Control Enable/Disable	4-9
1	Programmable Sensor Break	4-19
2	Continuous Self-tune	4-10
3	Auto Easy-tune	4-12
4	Control Output Action	4-19
5	Control Type	4-16
6	Loop Alarm Enable	4-15
7	Auto Pre-tune	4-13
8	Reserved	----
9	Loop Enable/Disable	4-9

4.4.2 Manual Control Enable/Disable

This parameter selects/de-selects Manual Control. When enabled, Manual Control Mode is used *temporarily* to control the process manually. The communications link is used to assign power levels to a control loop's output(s). The adjustment range is between 0% and +100% for a loop with only one (Primary) control output or between -100% and +100% for a loop with two (Primary and Secondary) control outputs. (Negative values apply power to the Secondary output; positive values apply power to the Primary output). Thus, to apply 25% power to the Secondary output of a two-output loop, the value should be -25%; to apply 50% power to a loop's Primary output, the value should be +50%.

NOTES

1. It is not possible to apply power to both outputs of a two-output control loop simultaneously in Manual Control Mode.
2. If a power failure or power-down occurs whilst a loop is in Manual Control Mode, the manual control output power setting at the instant of power interruption is saved; it is re-instated when power is restored.

Adjustment Range: 1 (Manual Control ON) or 0 (Manual Control OFF).

Default Value: 0 (Manual Control OFF).

Automatic Change: None.

Effects of Changes on Other Parameters: When Manual Control Mode is selected, an active Loop Alarm is turned off and Loop Alarm is disabled whilst Manual Control Mode is used. Upon exit from Manual Control Mode, the Loop Alarm is automatically re-enabled and its original state is restored.

4.4.3 Loop Enable/Disable

If the loop is disabled the status LED of the corresponding loop is turned off and the control loop stopped. All control outputs associated with that loop are turned off (inclusive of any Primary/Secondary outputs). The alarms configured for the disabled loop are suspended and will not be outputted on allocated outputs. Other loops alarms if still enabled will still be outputted. The control, outputs and alarms are returned to normal operation when the loop is re-enabled.

Adjustment Range: 0 (Loop Enabled) or 1 (Loop Disabled).

Default Value: 0 (Loop Enabled)

Automatic Change: None.

Effect of Changes on Other Parameters: None.

4.4.4 Manual Power

This parameter sets the percentage of output power when manual control is selected. This parameter is not applicable if Manual Control is not selected.

- Adjustment Range:** 0% (0x0000) to 100% (0x0064) (Primary output only configured) or -100% (0xFF9C) to +100% (0x0064) (Primary and Secondary outputs configured).
- Default Value:** 0% (0x0000)
- Automatic Change:** Forced within range, if necessary, when the Control Type is changed.
- Effect of Changes on Other Parameters:** None.

4.4.5 Enable/Disable Continuous Self-tune Facility

This parameter enables and disables the self-tune facility.

The self-tune is used to optimise tuning while a control loop is operating; it uses a pattern recognition algorithm, which monitors the process error (deviation signal). The diagram below shows a typical temperature application involving a process start up, setpoint change and load disturbance. The deviation signal is shown shaded and overshoots have been exaggerated for clarity. The Self-tune algorithm observes one complete deviation oscillation before calculating a set of PID values. Successive deviation oscillation causes values to be recalculated so that the controller rapidly converges on optimal control. When the control loop is switched off, the final PID terms remain stored in the Bus Modules non-volatile memory, and are used as starting values at the next switch on. The stored values may not always be valid, if for instance the Loop Modules is brand new or the application has been changed. In these cases the user can utilise Pre-tune. Use of continuous self-tune is not always appropriate for applications which are frequently subjected to artificial load disturbances, for example where an oven door is likely to be frequently left open for extended periods of time. Self-tune cannot be engaged if a controller is set for On-Off Control.

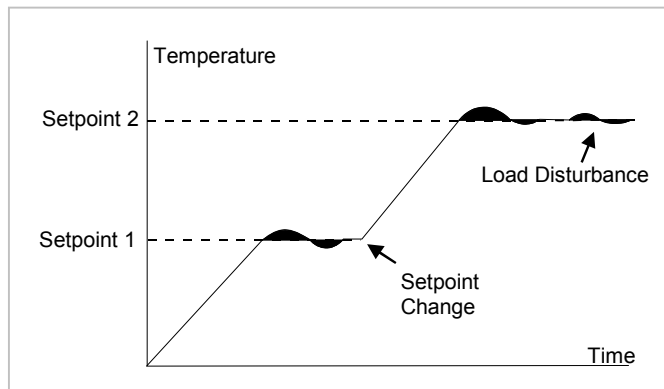

- Adjustment Range:** 1 (instigate/operating) or 0 (disable/disabled).
- Default Value:** 0 (disabled).
- Automatic Change:** None.
- Effect of Changes on Other Parameters:** While continues self-tune is in operation the PID terms may be effected.

4.4.6 Enable/Disable Easy-tune

This parameter enables/disables the Easy-tune facility.

Write operation:

- 1 = Instigate Easy-tune
- 0 = Disable Easy-tune

Read operation:

- 1 = Easy-tune operating
- 0 = Easy-tune disabled

NOTE: Not applicable when Control Type is set to Primary/Secondary (Heat/Cool).

Easy-tune is initiated on start-up (Auto-Easy-tune) or manually by setting this parameter. Easy-tune can be initiated at any time but will only operate when the process variable is at least 5% of the input span from the setpoint. Easy-tune calculates the optimum values for Proportional, Integral (Reset) and Derivative (Rate) after examining the system response to a step change in the output power.

When initiated for the first time Easy-tune applies 100% power to the process until the process variable reaches 2/3 of the difference between the starting temperature and the setpoint. Easy-tune then sets the power to 0% and examines the system response to calculate the PID terms. Easy-tune then records the overshoot and the time to peak values. This information is then used the next time easy-tune runs to move the point at which the power is reduced to 0%. Figure 4.4.5 shows a typical run of the Easy-tuning.

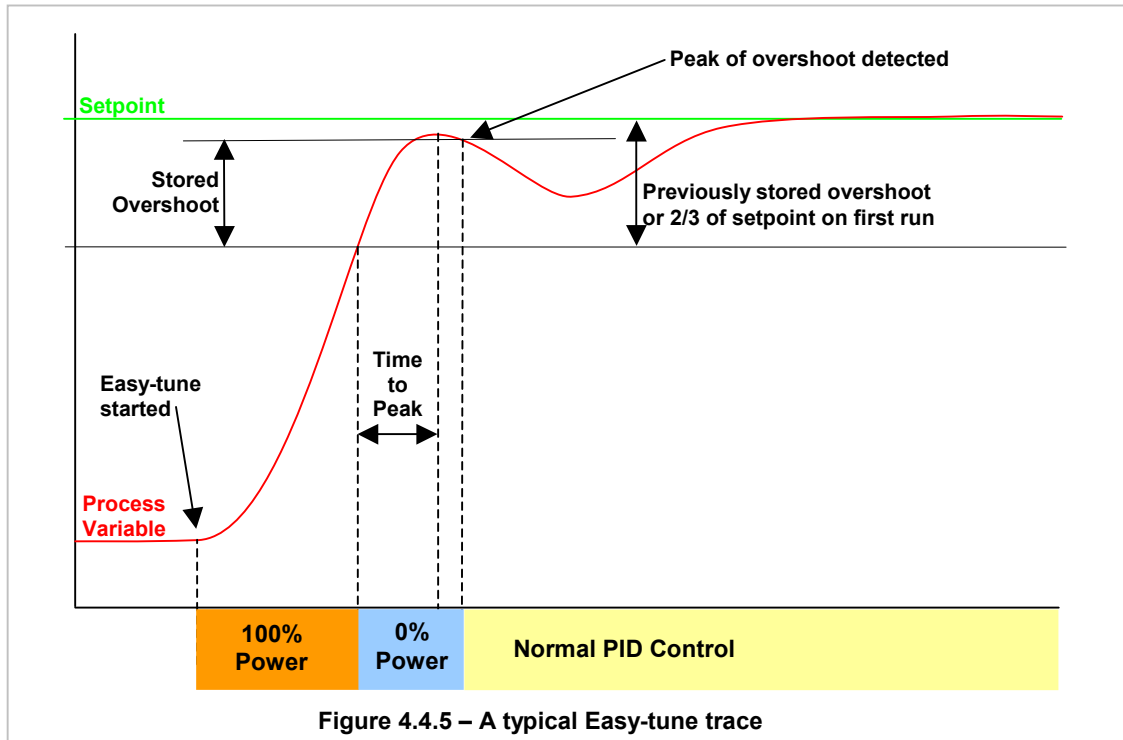

NOTES:

1. If the process has not cooled more than 5% of the inputs span below setpoint or by more that the stored overshoot value below setpoint, Easy-tune will not operate and PID terms and stored overshoot value will be unchanged. In processes with a large overshoot, this could lead to confusion as to whether Easy-tune is operating correctly or not.
2. Easy-tune will not run when Soft Start is running or if the control loop is set for ON/OFF control.
3. If the setpoint is changed at any time the stored over shoot values are reset to defaults.
4. When power is removed from the MLC 9000+ the stored over shoot values are reset back to default.

Adjustment Range: 1 (Easy-tune enabled) or 0 (Easy-tune disabled).

Default Value: 0 (Easy-tune disabled).

Automatic Change: Easy-tune is over-riden by Auto Pre-tune (it is possible to enable both facilities). Easy-tune will not be executed on Loop Modules with Primary and Secondary outputs, although it is possible to select Easy-tune for this configuration.

Effect of Changes on Other Parameters: Loop Alarm, if originally enabled, is disabled during Easy-tune execution and is re-enabled upon completion of the Easy-tune operation.

4.4.7 Auto Easy-tune

This parameter enables/disables the Auto Easy-tune facility that automatically executes the Easy-tune routine on power-up. A description of the Easy-tune facility is in [section 4.4.5](#).

- Adjustment Range:** 1 (Auto Easy-tune enabled - operates every power-up) or 0 (Auto Easy-tune disabled)
- Default Value:** 0 (disabled)
- Automatic Change:** Easy-tune is over-ridden by Auto Pre-tune (it is possible to enable both facilities). Easy-tune will not be executed on Loop Modules with Primary and Secondary outputs, although it is possible to select Easy-tune for this configuration.
- Effect of Changes on Other Parameters:** Loop Alarm, if originally enabled, is disabled during Easy-tune execution and is re-enabled upon completion of the Easy-tune operation.

NOTE: The Easy-tune routine will be executed only if the process variable is greater than 5% of input span or more than the stored over shoot from the setpoint. Easy-tune will not run when Soft Start is running or if the control loop is set for ON/OFF control.

4.4.8 Enable/Disable Pre-tune

This parameter controls/indicates the status of the single-shot Pre-tune routine:

Write operation:

- 1 = Start Pre-tune
- 0 = Disable Pre-tune

Read operation:

- 1 = Pre-tune operating
- 0 = Pre-tune disabled

Pre-tune is initiated either at power-up (see Auto Pre-tune) or manually using the Pre-tune parameter. Pre-tune can be initiated at any time but will only operate when the process variable is at least 5% of the input span from the setpoint. Pre-tune calculates optimum values of Proportional Band, Integral Time Constant and Derivative Time Constant after examination of system response to step changes in output power.

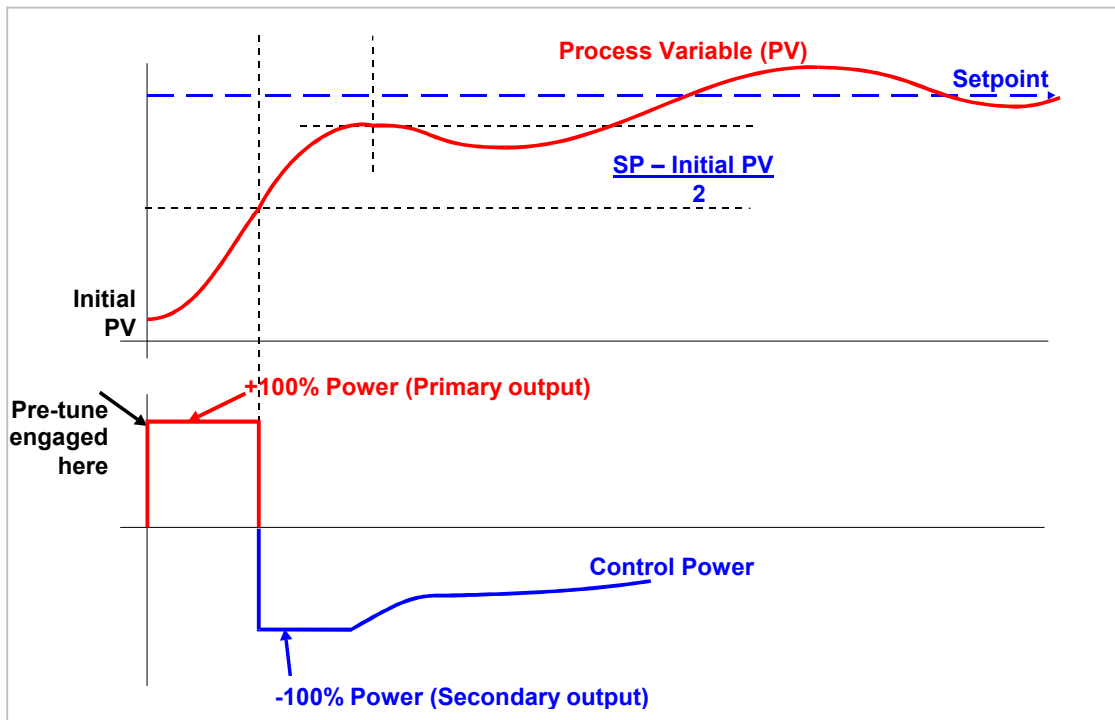

Pre-tune can be used on single output (Primary only) or dual output (Primary and Secondary) control loops.

Once it is started, Pre-tune will abort if disabled or if a soft start, manual power, a ramping setpoint, ON/OFF control mode or a sensor break occurs.

Adjustment Range:	1 (instigate/operating) or 0 (disable/disabled).
Default Value:	0 (disabled).
Automatic Change:	None.
Effect of Changes on Other Parameters:	When Pre-tune completes operation, PID terms may be affected.

NOTE: If Pre-tune is selected whilst Easy-tune is running, the Loop Module will ignore this selection; Pre-tune will remain disabled. Pre-tune will not operate when Soft Start is running.

4.4.9 Auto Pre-tune

This parameter enables/disables the Auto Pre-tune facility that automatically executes the single-shot Pre-tune routine on power-up. A description of the Pre-tune facility is in [figure 4.4.7](#).

Adjustment Range:	1 (Auto Pre-tune enabled - operates every power-up) or 0 (Auto Pre-tune disabled)
Default Value:	0 (disabled)
Automatic Change:	None.
Effect of Changes on Other Parameters:	Auto Pre-tune over-rides Easy-tune (it is possible to enable both facilities). If Auto Pre-tune is selected whilst Easy-tune is running, this will be ignored by the Loop Module until the next and subsequent power-ups, when Easy-tune will be disabled (over-ridden by Auto Pre-tune).

NOTE: The Pre-tune routine will be executed only if the process variable is greater than 5% of input span from the setpoint. Pre-tune will not run when Soft Start is running.

4.4.10 Primary Output Power Limit

This parameter defines the maximum percentage of primary output power. This can be used as protection to the controlled process. This parameter is not applicable if Proportional Band 1 = 0 (i.e. Output 1 = ON/OFF control).

Adjustment Range:	0% (0x00) – 100% (0x0064). 100% = <i>no protection</i> .
Default Value:	100% (no protection).
Automatic Change:	Not applicable if Proportional Band 1 is set to 0% (ON/OFF control).
Effect of Changes on Other Parameters:	None

4.4.11 Soft Start Parameters

The MLC 9000+ Soft Start is primarily intended to allow heaters to be dried out at start-up - condensation often forms when the heaters are cold. Soft Start allows the user to restrict the average power into the heaters, for a user-defined time period after start-up. It also keeps the heater-ON times to a minimum, to help avoid thermal shock effects. Soft Start has its own setpoint, allowing a low-temperature dwell period - while moisture evaporates - before going to full working temperature.

NOTES:

1. If the Primary output is connected to an internal Relay/SSR Drive then the Output Cycle Time, during Soft Start, for that output is set to 25% of its configured value, subject to a minimum of 0.5 seconds (therefore if the Output Cycle Time is set to 1 second it is actually reduced by 50% of it's value to 0.5 seconds). If the Output Cycle Time is already set to 0.5 seconds or less, it will not be reduced.
2. Soft Start is terminated if the PV is above the Soft Start Setpoint at start-up.
3. Soft Start only operates on Primary outputs. The Soft Start Primary Output Power Limit operation is only recommended for use with reverse-acting control outputs.

4.4.11.1 Soft Start Operation

Soft Start Setpoint (SSSP) is the setpoint used for the duration of Soft Start. Setpoint ramping is inhibited during Soft Start. It is not limited by SP Max/Min, only Range Max/Min - so tight limits can still be imposed on operator adjustment of the normal setpoint.

Soft Start Time (SSti) is adjustable from 0 to 60 min in 1 min intervals. If set to 0, Soft Start is disabled. Soft Start Time defines the duration of Soft Start - beginning at instrument power up. This method ensures that all zones can exit Soft Start together, even if the zones start dwelling at different times. It would be undesirable to start controlling some zones at 200°C, while other zones were still controlling to 100°C!

With Soft Start disabled, The Output Power Limit operates by limiting the maximum power demand from the controller. With Soft Start enabled however, the Output Power Limit only operates during Soft Start; after Soft Start completes the Output power is allowed up to 100%, ignoring the limit value.

If Soft Start is enabled - having been previously disabled - Soft Start will not activate until the next start-up, no matter what value is set for Soft Start Time. However, Output power will immediately be allowed up to 100%, Output Power Limit only being heeded during subsequent soft starts.

During Soft Start the time proportioning cycle time used for control Output is a quarter the value of control Output Cycle Time, but will never be less than 0.5s. So if control Output Cycle Time is 1s, and control Output Power Limit is 20%, during Soft Start the heater-ON pulses will be restricted to 0.1s.

In the three loop modules Z3611, Z3621 and Z3651 the heater current readings are suspended until soft start has completed.

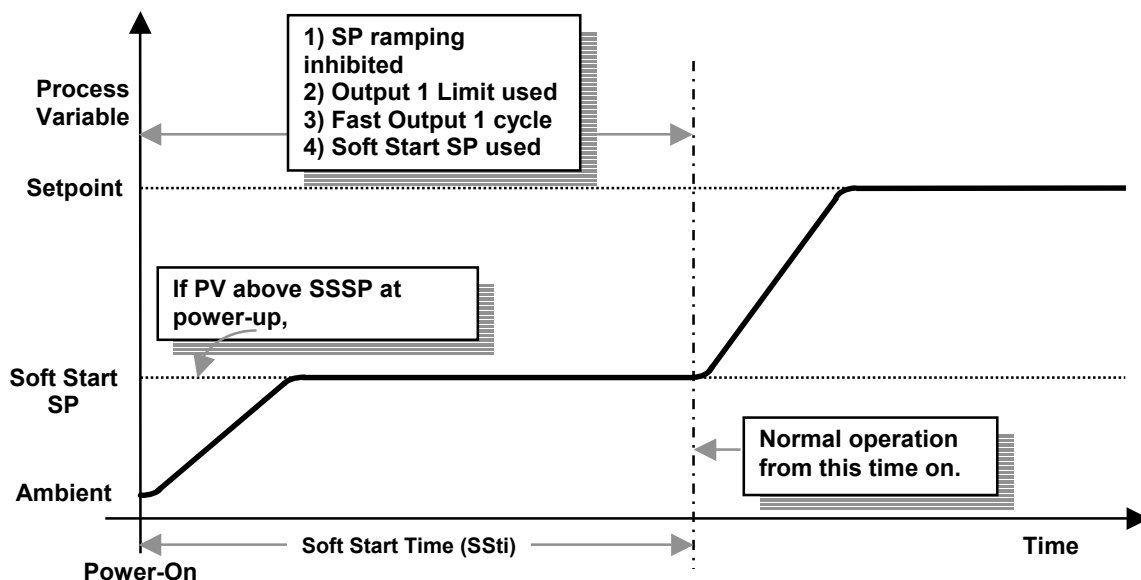

4.4.11.2 Soft Start Setpoint

This parameter defines the value of setpoint used during the Soft Start time period.

Adjustment Range:	Input Scale Range Minimum to Input Scale Range Maximum.
Default Value:	Input Scale Range Minimum.
Automatic Change:	Forced to default value if forced out of range by a change to Input Range, Input Scale Range Maximum or Input Scale Range Minimum. The units for this parameter are changed if the Input Units are changed.
Effect of Changes on Other Parameters:	None

4.4.11.3 Soft Start Time

This parameter defines the duration of the Soft Start period.

Adjustment Range:	0 to 60 minutes in 1-minute increments (0 = no Soft Start).
Default Value:	0 (no Soft Start).
Automatic Change:	None
Effect of Changes on Other Parameters:	Values other than zero stop Easy Tune and Pre-Tune from working.

4.4.11.4 Soft Start Primary Output Power Limit

This parameter defines the Output Power Limit used instead of Primary Output Power Limit during the Soft Start period.

Adjustment Range:	0 - 100%
Default Value:	100%
Automatic Change:	This parameter is forced within range, if necessary, when the Control Type is changed.
Effect of Changes on Other Parameters:	None

4.4.12 Primary Output Power

This parameter indicates the current Primary output power level. It is in the range 0% to 100% (0x0064).

4.4.13 Secondary Output Power

This parameter indicates the current Secondary output power level. It is in the range 0% to 100% (0x0064).

4.4.14 Loop Alarm Enable

This parameter enables/disables the Loop Alarm.

The Loop Alarm is a special alarm, which detects faults in the control feedback loop by monitoring continuously process variable response to the control output(s).

When enabled, the Loop Alarm repeatedly checks the control output(s) for saturation (i.e. either output being at the maximum or minimum limit). If an output is found to be in saturation, the Loop Alarm starts a timer; thereafter, if the saturated output has not caused the process variable to be corrected by a pre-determined amount **V** after a time **T** has elapsed, the Loop Alarm goes active. Subsequently, the Loop Alarm repeatedly checks the process variable and the control output(s). When the process variable value starts to change in the correct sense or when the saturated output

comes out of saturation, the Loop Alarm is de-activated. For PID control, the Loop Alarm Time **T** is always set to 2 x Reset (Integral Time Constant) value. For ON/OFF control, the user-defined Loop Alarm Time value is used.

The value of **V** is dependent upon input type:

°C ranges: 2°C or 2.0°C

°F ranges: 3°F or 3.0°F

Linear ranges: 10 least significant digits

For single output control, the output saturation limits are 0% and Primary Output Power Limit. For dual-output control, the output saturation limits are –100% and Primary Output Power Limit.

NOTE: Correct operation of the Loop Alarm depends upon reasonably accurate PID tuning.

Adjustment Range:	0 (Disabled) or 1 (Enabled).
Default Value:	0 (Disabled).
Automatic Change:	If Loop Alarm is originally enabled, it is disabled when Manual Control Mode is selected and is re-enabled when exit is made from Manual Control Mode. If Loop Alarm is originally enabled, it is disabled during Easy Tune execution and is re-enabled upon completion of the Easy Tune operation.
Effect of Changes on Other Parameters:	None

4.4.15 Loop Alarm Status

This parameter indicates the current status of the Loop Alarm (1 = active, 0 = inactive). See also Loop Alarm Enable and Loop Alarm Time.

4.4.16 Control Type

This parameter selects single (Primary only) or dual (Primary and Secondary) output control.

Adjustment Range:	0 (Primary only) or 1 (Primary and Secondary).
Default Value:	0 (Primary only).
Automatic Change:	None.
Effect of Changes on Other Parameters:	Valid values of % Power parameters will be forced within range. When going from a Primary/Secondary type to a Primary only the output power will be forced within 0 – 100%.

4.4.17 Proportional Band 1

This parameter defines the percentage of input span over which the Primary output power level is proportional to the process variable. Refer to [Figure 4.4.5](#).

Adjustment Range:	0.0% - ON/OFF control (0x0000) or within the range 0.5% (0x0005) to 999.9% (0x270F).
Default Value:	10.0% (0x64)
Automatic Change:	Is forced to default value if Input Range is changed.
Effect of Changes on Other Parameters:	Forces Loop Alarm Time/Reset Time Constant to default value on entry into or exit from ON/OFF control.

4.4.18 Proportional Band 2

This parameter defines the percentage of input span over which the Secondary output power level is proportional to the process variable. Refer to [Figure 4.4.5](#).

Adjustment Range:	0.0% - ON/OFF control (0x0000) or within the range 0.5% (0x0005) to 999.9% (0x270F).
Default Value:	10.0% (0x64)
Automatic Change:	This parameter is forced to its default value if Input Range is changed.
Effect of Changes on Other Parameters:	None.

4.4.19 Reset (Integral Time Constant)/Loop Alarm Time

This parameter defines the value of the Integral Time Constant (if Proportional Band 1 \neq 0 - PID control) or (if Proportional Band 1 = 0 - ON/OFF control) the Loop Alarm Time value. The Loop Alarm Time parameter is not applicable if the Loop Alarm has been disabled.

Adjustment Range:	1 sec. (0x0001) to 5999 secs. (0x176F) and OFF (0x0000).
NOTE:	For ON/OFF control (Proportional Band 1 = 0), Loop Alarm Time is the user-defined duration of the output saturation condition after which the Loop Alarm is activated. For proportional control (Proportional Band 1 \neq 0), Loop Alarm Time is set automatically to 2 x Reset time.
Default Value:	300 secs (PID control) or 5999 secs (ON/OFF control).
Automatic Change:	Forced to default value if Input Range is changed or from entry into or exit from ON/OFF Control (i.e. Proportional Band 1 is changed from/to 0)
Effect of Changes on Other Parameters:	None

4.4.20 Rate (Derivative Time Constant)

This parameter determines the Derivative Time Constant value. This parameter is not applicable if Proportional Band 1 = 0 (ON/OFF control)

Adjustment Range:	0 secs. (0x0000) to 5999 secs. (0x176F).
Default Value:	75 secs.
Automatic Change:	This parameter is forced to its default value if Input Range is changed.
Effect of Changes on Other Parameters:	None

4.4.21 Overlap and Deadband

This parameter defines the percentage of (Proportional Band 1 + Proportional Band 2) over which both Primary and Secondary outputs are active (overlap) or neither is active (deadband). This parameter is not applicable if Proportional Band 1 is set to 0 (ON/OFF control). The operation of overlap/deadband is illustrated in [Figure 4.4.5](#).

- Adjustment Range:** -20% (0xFFEC) to +20% (0x0014) (negative value = deadband, positive value = overlap).
- Default Value:** 0% (0x0000).
- Automatic Change:** Forced to default value if the Input Range is changed.
- Effect of Changes on Other Parameters:** None

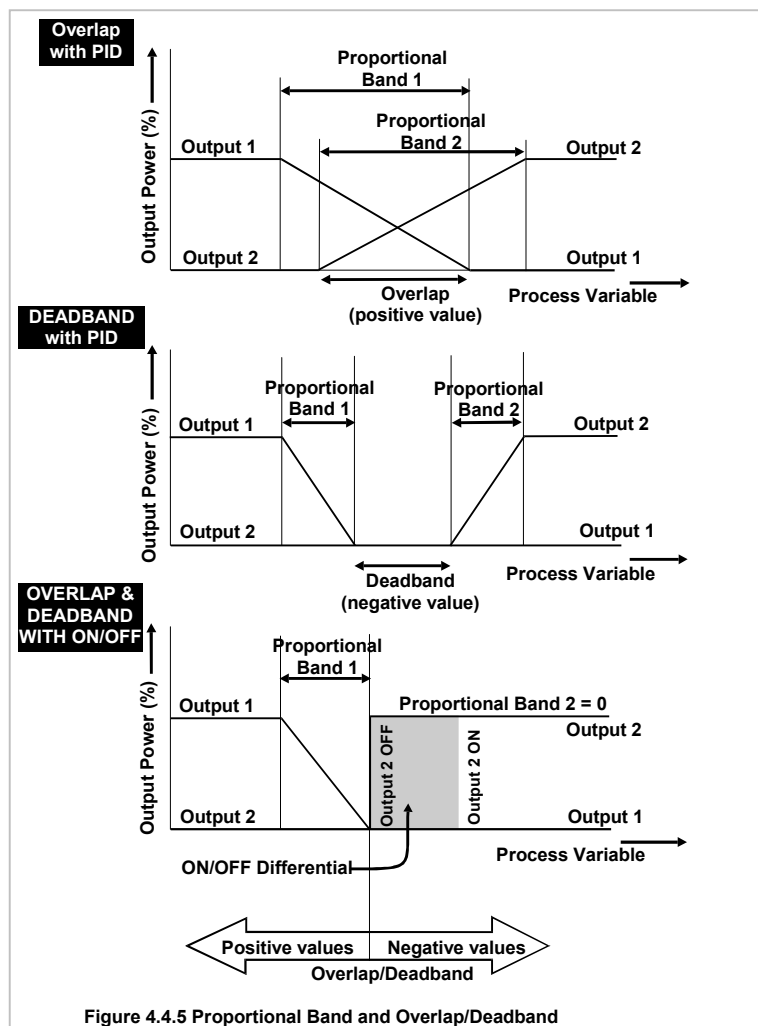

4.4.22 Bias (Manual Reset)

This parameter defines the bias added to output power, expressed as a percentage of Primary output power. This parameter is not applicable if Proportional Band 1 is set to 0 (ON/OFF control). If the process is below setpoint use a positive Bias value to remove the error, if the process variable is above the setpoint use a negative Bias value. Lower Bias values will also help to reduce overshoot at process start up.

Adjustment Range:	0% (0x0000) to 100% (0x0064) (Primary output only configured) or -100% (0xFF9C) to +100% (0x0064) (Primary and Secondary outputs configured).
Default Value:	25% (0x0019).
Automatic Change:	Forced to default value if the Input Range is changed.
Effect of Change on Other Parameters:	None

4.4.23 ON/OFF Differential

This is the switching differential used with one output or both outputs set to ON/OFF control (Proportional Band = 0). The operation of ON/OFF Differential is illustrated in [Figure 4.4.5](#).

Adjustment Range:	0.1% (0x0001) to 10.0% (0x0064) of input span.
Default Value:	5% (0x0005).
Automatic Change:	Forced to default value if Input Range is changed.
Effect of Change on Other Parameters:	None

4.4.24 Control Output Action

This parameter determines the action of the PID control algorithm for the associated output.

Adjustment Range:	0 (reverse-acting) or 1 (direct-acting).
Default Value:	0 (reverse-acting).
Automatic Change:	None.
Effect of Changes on Other Parameters:	None

4.4.25 Programmable Sensor Break

This parameter determines the output power setting in the event of a Sensor Break condition.

Adjustment Range:	1 (ON - Power held at current value, if Reset is non-zero, or at Bias value, if Reset = 0) or 0 (OFF - Preset Power Output used).
--------------------------	---

NOTE: For safety purposes, the output power level on Sensor Break is limited by Preset Power Output. For ON/OFF control, Programmable Sensor Break is disabled and both Secondary and Primary outputs are forced to zero when a sensor break is detected.

Default Value:	0 (OFF).
Automatic Change:	None.
Effect of Changes on Other Parameters:	None

4.4.26 Preset Power Output

This parameter defines the output power level that will be set when, with Programmable Sensor Break OFF sensor break condition occurs.

Adjustment Range:	0% (0x0000) to 100% (0x0064) (Primary output only configured) or –100% (0xFF9C) to +100% (0x0064) (Primary and Secondary outputs configured).
Default Value:	0% (0x0000).
Automatic Change:	Forced within range, if necessary, when the Control Type is changed.
Effect of Changes on Other Parameters:	None

4.5 Alarm Parameters

4.5.1 Alarm Type

This parameter selects the alarm type (Figure 4.5.1). The characteristics of the alarm types are shown in the table below:

Alarm Type	Minimum Value	Maximum Value	Default	Alarm Action
Process High	Input Range Min.	Input Range Max.	Input Range Max.	Active when PV ≥ alarm value
Process Low	Input Range Min.	Input Range Max.	Input Range Min.	Active when PV ≤ alarm value
Band Alarm	1	Span – Limited to 7D00 (32000dec.)	5 input units	Active when PV – SP is outside band
Deviation Alarm	- (span) – Limited to 0xFD00 (-32000dec.)	+ (span) – Limited to 0xFD00 (+32000dec.)	5 input units	Active when (PV – SP) > alarm value

Adjustment Range: 0 (Process High Alarm) 2 (Band Alarm)
1 (Process Low Alarm) 3 (Deviation Alarm).

Default Value: 0 (Process High Alarm).

Automatic Change: None

Effect of Changes on Other Parameters: Alarm Value forced to default value for new alarm type.

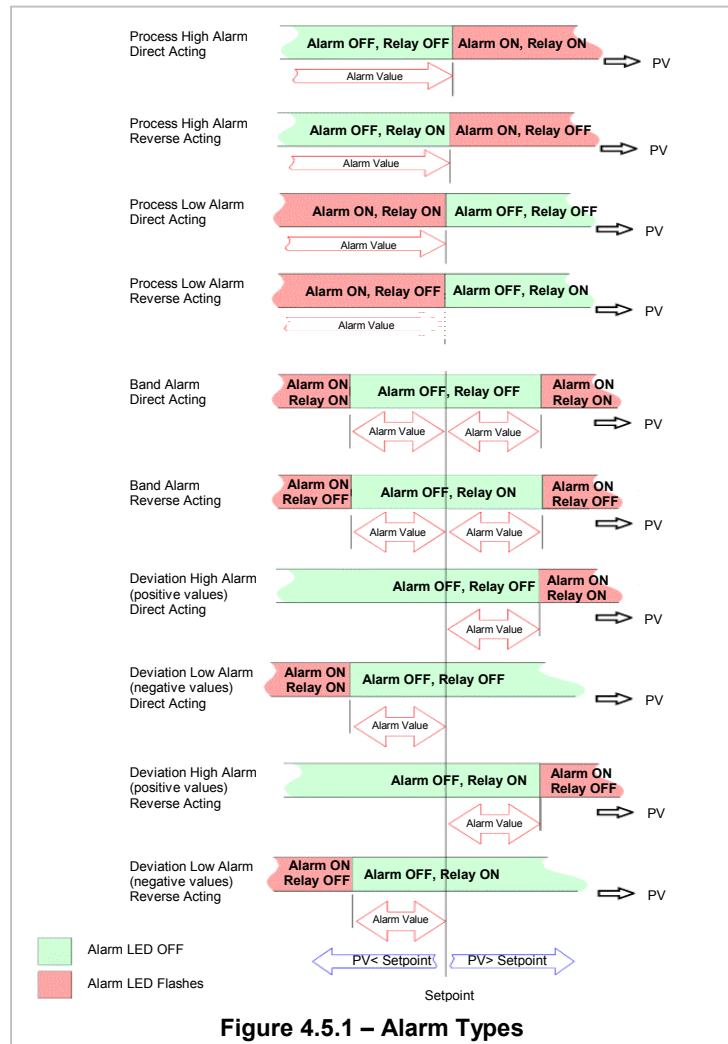

4.5.2 Alarm Hysteresis

This parameter defines the width of a hysteresis band on the “safe” side of the alarm level for the applicable alarm. Its operation is illustrated in [Figure 4.5.2](#).

- Adjustment Range:** 1 input unit (0x0001) to 250 input units (0x00FA).
- Default Value:** 1 input unit (0x0001).
- Automatic Change:** If a change to Input Range, Input Scale Range Maximum or Input Scale Range Minimum forces this parameter out of range, it will be set to its default value. If Input Units is changed, the units for this parameter will change accordingly.
- Effect of Changes on Other Parameters:** None.

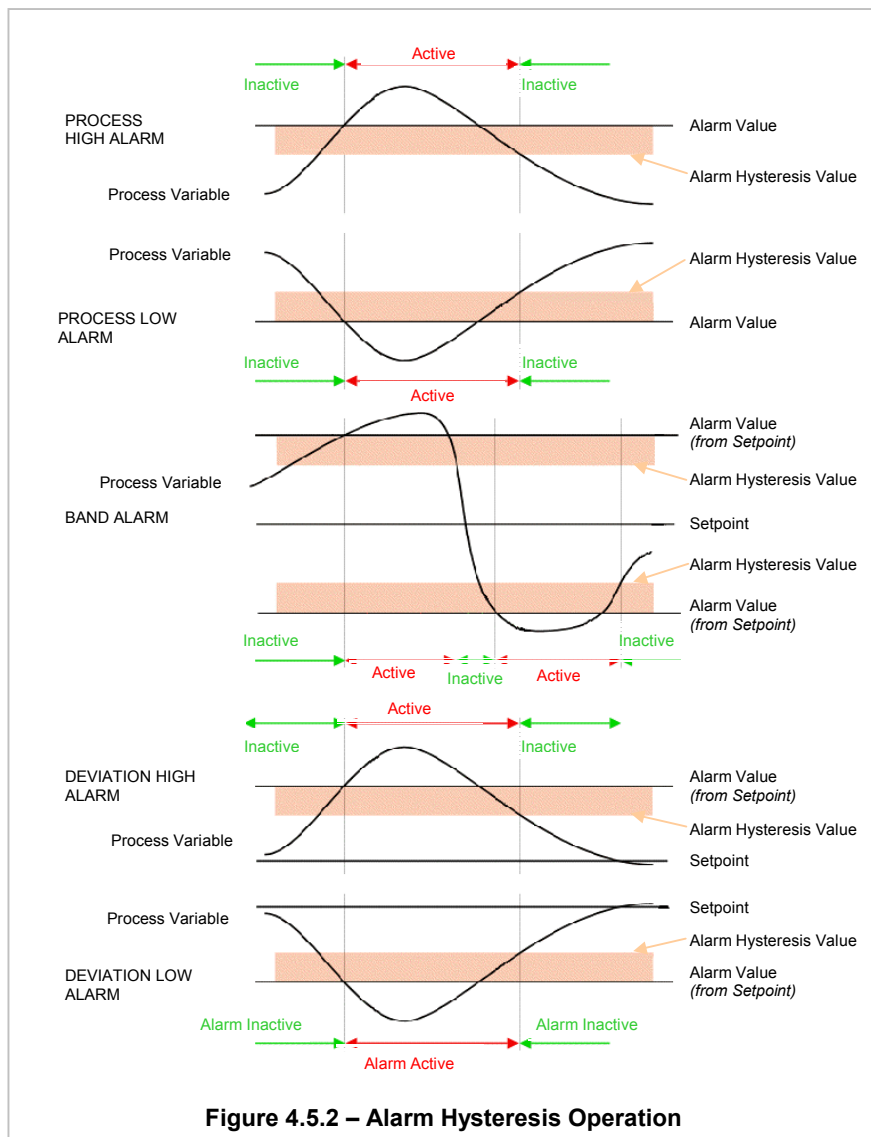

4.5.3 Alarm Value

This parameter determines the value at which the alarm becomes active. The function/adjustment range of this value depends upon alarm type (see table in [Subsection 4.5.1](#) and [Figure 4.5.1](#)).

Default Value:	Dependent upon alarm type; see table above.
Automatic Change:	If a change to Input Range, Input Scale Range Maximum or Input Scale Range Minimum forces this parameter out of range, it will be set to its default value. This parameter is automatically set to its new default value if Alarm Type is changed. If Input Units is changed, the units for this parameter will change accordingly.
Effect of Changes on Other Parameters:	None.

4.5.4 Alarm State

This parameter indicates the state of the applicable alarm (1 = active, 0 = inactive).

4.5.5 Alarm Inhibit

This parameter enables/disables the Alarm Inhibit feature. When Alarm Inhibit is enabled, it inhibits an alarm at power-up until that alarm enters the inactive area (inactive area defined in [figure 4.5.2](#). Alarm Inhibit also operates in similar manner (for dual setpoint operation) on deviation alarms and band alarms for changes from one setpoint to another.

Adjustment Range:	1 (enabled) or 0 (disabled).
Default Value:	0 (Disabled).
Automatic Change:	None.
Effect of Changes on Other Parameters:	None.

4.6 4.6 Heater Current Parameters

These parameters relate only to Loop Controller Modules with the Heater Current Input option. The “Soft” Heater Current Alarm may be connected to a physical output via the parameters of the Output Class. The Heater Current Input Option is available on Loop Modules Z1301, Z3621, Z3611 and Z3651 only.

4.6.1 Heater Current value

This parameter indicates the heater current value that has been filtered to give a stable value. When the Primary Output cycles off, the value is frozen at the last valid reading - it does not drop to zero. At power up the Ammeter reading is initially set to zero, and will remain so until the Primary Output has been on long enough to obtain a valid reading. (300ms)

Note: if the current value reads zero when you don't expect it to, the first thing to check is if the Primary Output has turned on since powering up the MLC 9000+. This value can be ranged between 0 (0.0) to 10000 (1000.0).

4.6.2 Heater Current Input Type

This parameter defines the heater current input source and span setting.

Adjustment Range:	0 - Standard: External current transformer used. Permits the use of the Low Heater Break Alarm, High Heater Break Alarm and Short-circuit Heater Break Alarm
	1 - SCRi: Two-wire connection to a special thyristor unit (SCRs). Permits the use of Low Heater Break Alarm and High Heater Break Alarm but not Short-circuit Heater Break Alarm. (This input type can not be used on a Z3611, Z3621 and Z3651)

	2 - Bus	External input of a heater current value from the fieldbus.
Default Value:		0 (Standard).
Automatic Change:		None.
Effect of Changes on Other Parameters:		Forces to default values: Heater Current Scale Range Max. and Bus Input value. If either is forced out of range, forces to default values: Low Heater Break Alarm and High Heater Break Alarm

4.6.3 Heater Current Scale Range Maximum

This parameter defines the scale limit for the heater current (when current transformer secondary current is 50mA).

Adjustment range:	10.0A to 1000.0A in 0.1A increments.
Default Value:	50.0A.
Automatic Change:	Set to default value when Heater Current Input Range is changed.
Effect of Changes on Other Parameters:	If either is forced out of range, forces to default values Low Heater Break Alarm and High Heater Break Alarm.

4.6.4 Low Heater Break Alarm value

This parameter determines the level of heater current below which the Low Heater Break Alarm becomes active. Low HBA is the most common type - and generally the most useful. A low HBA is typically used for early detection of heater element failure; it detects whether the heater current is lower than it should be. If multiple heater elements are in use, and one fails, the normal control action will simply demand more "power" to compensate, and null out the error. This results in the remaining heater elements becoming over-stressed, with ever-increasing risk of total heater failure. In the meantime product quality can suffer due to uneven heating effects. A low heater break alarm can be used to detect such conditions.

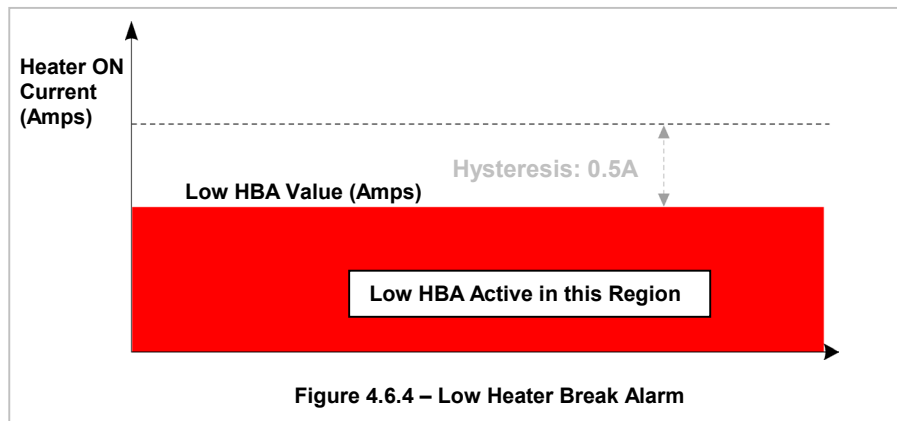

Adjustment range:	0 (OFF) to Heater Current Scale Range Maximum.
Default Value:	0 (OFF).
Automatic Change:	If a change in Heater Current Input Range or Heater Current Scale Range Maximum causes this parameter to be out of range, it will be set to its default value.
Effect of Changes on Other Parameters:	None.

4.6.5 High Heater Break Alarm value

This parameter determines the level of heater current above which the High Heater Break Alarm becomes active. High HBA is useful for detecting partial shorts between heater elements, etc; it detects whether the heater current is higher than it should be. This feature should be used with discretion however - some over-current conditions will require very rapid current-limiting action: the MLC 9000+ is not designed to deal with such situations. As a general rule-of-thumb - allowing for sampling and filtering delays - the MLC 9000+ can be relied upon to respond within a few seconds; if a quicker response is required then more appropriate current limiting provisions must be made.

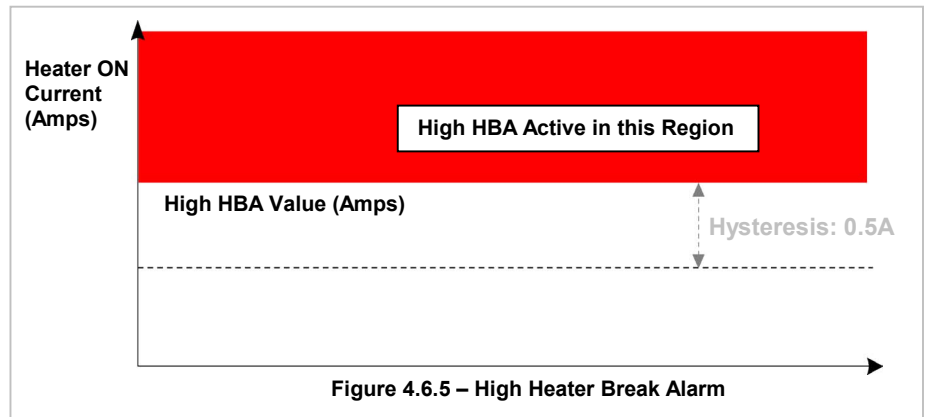

Adjustment range:	0 to Heater Current Scale Range Maximum (OFF).
Default Value:	Heater Current Scale Range Maximum (OFF).
Automatic Change:	If a change in Heater Current Input Range or Heater Current Scale Range Maximum causes this parameter to be out of range, it will be set to its default value.
Effect of Changes on Other Parameters:	None

4.6.6 Low Heater Break Alarm state

This parameter indicates the state of the Low Heater Break Alarm (0 = inactive, 1 = active).

4.6.7 High Heater Break Alarm state

This indicates the state of the High Heater Break Alarm (0 = inactive, 1 = active).

4.6.8 Short Circuit Heater Break Alarm Enable/Disable

This parameter enables/disables the Short Circuit Heater Break alarm. Short Circuit HBA is typically used to detect if the heater control device is stuck ON - welded relay contacts, short circuit Thyristors etc. This alarm is based on heater current readings acquired whilst the Heat Output is OFF - the off-current value. If any significant heater current is detected when the heater is supposed to be OFF, the short circuit HBA will trip. The term "Short Circuit HBA" is really a misnomer, but is widely used. A true short circuit could result in very high currents, very rapidly! The MLC 9000+ could not react in time to

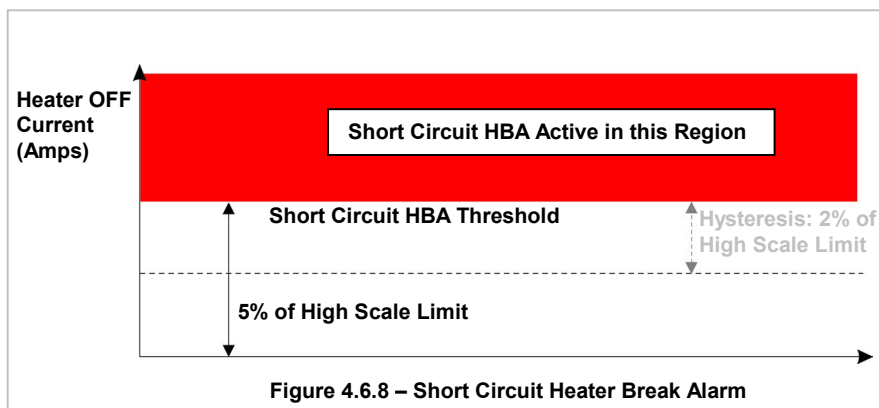

this. Suitable fuses should always be fitted.

The Short Circuit HBA has an alarm value fixed at 5% of Heater Current High Scale Limit. The S/C HBA goes active if - when the heater is supposed to be OFF - the heater current exceeds this 5% level. The alarm goes inactive when the off current drops below 3% of Heater Current High Scale Limit.

This alarm is not available when using the 2-wire SCRI and BUS connection method.

Adjustment range:	0 (disabled) or 1 (enabled).
Default Value:	1 (enabled).
Automatic Change:	None.
Effect of Changes on Other Parameters:	None

4.6.9 Short Circuit Heater Break Alarm state

This indicates the state of the Short Circuit Heater Break Alarm (0 = inactive, 1 = active). This alarm goes active when heater current is detected and the Primary output is not on.

4.6.10 Heater Current Bus Input value

This parameter provides for an input source from the Fieldbus. It is available when Heater Current Input Range parameter is set to Bus.

Adjustment Range:	0 to Heater Current Scale Range Maximum.
Default Value:	0.
Automatic Change:	Set to default value when Heater Current Input Range is changed.
Effect of Changes on Other Parameters:	None

4.6.11 Heater Period (Modules Z3621, Z3611 and Z3651 only)

This parameter defines the interval between cycles of the control outputs to determine the heater current for each loop. Every specified time interval one of the control outputs is turned on while the others are off. A current reading is then made for that loop. The next loop is then turned on with the others off and a current reading is made, this is repeated until all control loop current readings have been made. This process will take no longer than 2 seconds. The Loop Module then waits the specified time (Heater Period) until repeating the whole process. This makes it possible to read all three heater current values with only one current transformer input.

Adjustment Range:	1 – 15min
Default Value:	1min.
Automatic Change:	None
Effect of Changes on Other Parameters:	None

4.7 Calibration Parameters



WARNING: Calibration must be carried out only by personnel who are technically competent and authorised to do so. *Incorrect calibration will cause the MLC 9000+ to malfunction.*

The calibration procedure for the Loop Control Module comprises five phases, according to the calibration source required:

- Phase 1: 50.000mV source connected to the appropriate Linear Input (mV) terminals.
- Phase 2: 10.000V source connected to the appropriate Linear Input (V) terminals
- Phase 3: 20.000mA source connected to the appropriate Linear Input (mA) terminals
- Phase 4: 200.000Ω connected to the appropriate RTD Input terminals
- Phase 5: 0°C reference connected to the appropriate Thermocouple Input terminals (Type K Thermocouple, @ 0°C)

For information on input connections, refer to [Section 2](#).

To calibrate the MLC 9000+ follow the procedure outlined in the calibration Wizard for the module to be calibrated.

4.7.1 Calibration Phase

This parameter selects/indicates the calibration phase which subsequent writing of the correct Calibration Password will initiate.

Adjustment Range: 1 to 5

4.7.2 Calibration Password

This parameter defines the value which, when written, initiates calibration. When read, this parameter returns either 0xFFFF (Pass) or 0x0000 (Fail).

Adjustment Range: 0xCAFE

4.8 Loop Module Descriptor Parameters

4.8.1 Serial Number

This Read Only parameter indicates the Serial Number of the Loop Module. It is burnt into the Loop Modules EEPROM at manufacture. It is in the numeric range 0 to 999 999 999 999.

4.8.2 Firmware ID

This Read Only parameter indicates the Loop Module firmware version and issue number. It is in the range 0 to 2^{16} . The format of the ID word is:

Bits 0 - 4: Revision Number (1, 2, etc.)

Bits 5 - 9: Alpha version (A = 0, B = 1, etc.)

Bits 10 - 15: Numeric version (single loop Module = 0, multiple-loop Module = 2)

4.8.3 Date of Manufacture

This parameter returns the date the Bus Module was manufactured. The format is Day/Month/Year.

4.8.4 Product Identifier

This Read Only parameter identifies the valid versions of database for the Loop Module:

1	Z1200
2	Z1300
3	Z1301
4	Z3611
5	Z3621
6	Z4610
7	Z4620
8	Z3651
9	Z4660

When changing Loop Modules, auto-configuration of the Loop Module database will occur only if the Product Identifier of the replacement Loop Module is identical to that of the removed Loop Module.

4.8.5 Loop Module Status indicators

Only 8 bit words can be placed into the data assembly table. If there is a requirement for more than 8 words then these status word can be used and have the following bit make up below.

Status Indicators

	Z1200, Z1300, Z1301	Z3611, Z3621, Z3651, Z4611, Z4621, Z4660
Bit	Parameter Name	Parameter Name
0	Over-range state	Over-range state
1	Under-range state	Under-range state
2	Sensor Break state	Sensor Break state
3	Reserved	Reserved
4	Loop Alarm state	Loop Alarm state
5	Easy-tune state	Easy-tune state
6	Pre-tune state	Pre-tune state
7	Self-tune state	Self-tune state
8	Alarm 1 state	Alarm 1 state
9	Alarm 2 state	Alarm 2 state
10	Output 1 state	Output 1 state
11	Output 2 state	Output 2 state
12	Output 3 state	Output 3 state
13	Low Heater Break Alarm state	Output 4 state
14	High Heater Break Alarm state	Output 5 state
15	Short-circuit Heater Break Alarm state	Output 6 state

4.9 Bus Module Communication Port Parameters

The configuration port parameters are present on all types of Bus Modules. The fieldbus port parameters change depending on the Bus Module. Refer to the appropriate Fieldbus port section for the port parameters.

4.9.1 Configuration Port Data Rate

This parameter sets the data transfer rate for the configuration port. This has to be set to the same value as the PC used to connect to the MLC 9000+.

Warning: if this parameter is changed the PC configuration will also need to be changed to match otherwise communication with the MLC 9000+ will be lost.

Adjustment Range:

0 (1200 Baud)	4 (19200 Baud)
1 (2400 Baud)	5 (38400 Baud)
2 (4800 Baud)	6 (57600 Baud)
3 (9600 Baud)	7 (115200 Baud)

Default Value: 6 (57600 Baud).

4.10 Bus Module Descriptor Parameters

4.10.1 Serial Number

This Read Only parameter indicates the Serial Number of the Bus Communications Module. It is burnt into the Bus Modules EEPROM at manufacture. It is in the numeric range 0 to 999 999 999 999.

4.10.2 Date of Manufacture

This parameter returns the date the Bus Module was manufactured. The format is Day/Month/Year.

4.10.3 Product Identifier

This Read only parameter identifies the hardware build variant. It is burnt into the Bus Modules EEPROM at manufacture. Value is one of:

- 1 = BM220 (RS485)
- 2 = BM250 (Ethernet)
- 3 = BM240 (PROFIBUS)

4.10.4 Database ID

This Read only parameter indicates the Bus Module Fieldbus database installed.

- 1 = MODBUS
- 2 = Devicenet
- 4 = PROFIBUS DP
- 5 = Ethernet/IP
- 6 = MODBUS/TCP

4.11 Data Assemblies

A Data Assembly is a user-defined collection of parameters that the Bus Module collates from its associated Loop Modules so that the higher level PLC, SCADA or HMI connected to the Fieldbus port can collect the required parameter data in one message transaction.

There are two user definable data assemblies defined as parameters that are to be transferred from the MLC 9000+ to the supervisory system (read) and parameters that are to be transferred from the supervisory system to the MLC 9000+ (write)

Using the MLC 9000+ Workshop software the user defines the parameters to fill the data assembly area.

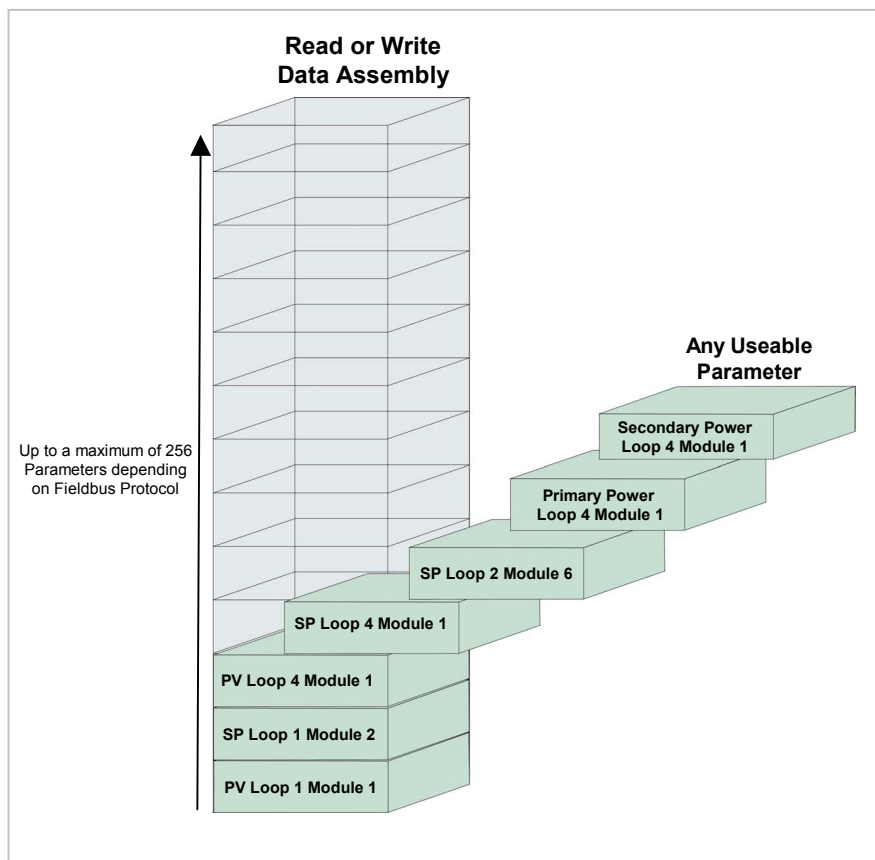

The number of parameters in total for both the read and write data tables is 256. The maximum number of parameters is restricted by the fieldbus protocol being used. Refer to the relevant protocol section for the maximum number of parameters.

4.11.1 Startup and Removal of Loop Modules

On initial startup/power on of the MLC 9000+ system all values in data assembly will read 0xFFFF, this will also be the case when a hot swap/removal of loop module is carried out.

This must be taken into consideration when programming alarms and other use of parameters that are value dependant.



5 OVERVIEW OF MODBUS RTU COMMUNICATIONS (BM220-MB)

5.1 Introduction

The BM220-MB is used to connect a MLC 9000+ system to a MODBUS RTU master device. The following section describes the format of this connection. More information can be found on the MODBUS website www.modbus.org.

NOTE: Unless otherwise specified, all numbers in this Section are expressed in decimal form. Where hexadecimal numbers are used, they have the suffix 0x00.

5.2 Interface Configuration

There are 4 parameters associated with interfacing the MODBUS Bus Module to a MODBUS network;

1. **Address:** This parameter sets the MODBUS address of the Bus Module. This can be any value between 1 and 247. Default address is 96 (0x60)
2. **Data Rate:** This is the data rate at which the MODBUS network communicates. The following data rates are supported by the MLC 9000+: 2.4kb, 4.8kb, 9.6kb, 19.2kb
3. **Data Format:** This parameter defines the parity for the MODBUS message. None, Even and Odd parity are supported.
4. **Data Assemblies:** These are the user defined read and write data tables used for more efficient communications.

When any of the above parameters are changed the Bus Module requires a power cycle for the changes to take effect.

5.3 MODBUS Functions Supported

Code (hex)	MODBUS Function	Meaning
01 or 02	Read Coil/Input Statue	Read input /output status bits at given address
03 or 04	Read Holding/Input Register	Read current binary value of data bytes at given address
05	Force Single Coil	Write a single binary bit to the specified word address
06	Pre-set Single Register	Write two bytes to the specified address
08	Diagnostics	Used only for loopback test
0x0F	Force Multiple Coils	Write consecutive bits to the specified address range.
0x10	Pe- set Multiple Registers	Write consecutive two-byte values to the specified address range.
0x17	Read/Write Multiple Registers	Read and Write multiple Registers at the same time.

More detail on each MODBUS function is given in the following Subsections.

5.3.1 Read Coil/Input Status (Function 01/02)

Either Function 01 or Function 02 may be used interchangeably to read the content of the status bits at the specified bit address. The format is:

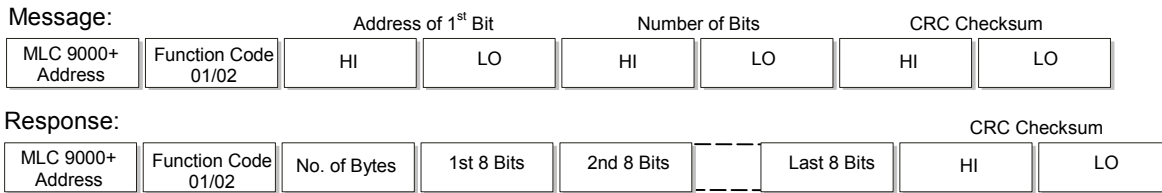

In the response, the “No. of Bytes” indicates the number of data bytes read from the addressed Loop Controller Module (e.g. if 16 bits are returned, the count will be 2). The maximum number of bits that can be read is 32. The first bit read is the least significant bit of the first eight bits requested.

Note: These function codes are not supported for accessing information from the BUS Control Module BCM

5.3.2 Read Holding/Input Registers (Function 03/04)

Either Function 03 or Function 04 may be used interchangeably to read the current binary value of the data at the specified word address. The format is:

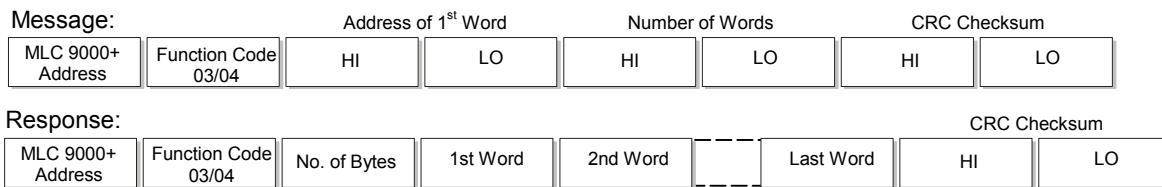

In the response, the “No. of Bytes” indicates the number of data bytes read from the Loop Controller Module e.g. if five words (10 bytes) are read, the count will be 0x0A. The maximum number of words which can be read is 64 returned in 128 bytes.

5.3.3 Force Single Coil (Function 05)

This function writes a single binary value to the specified slave bit address. The format is:

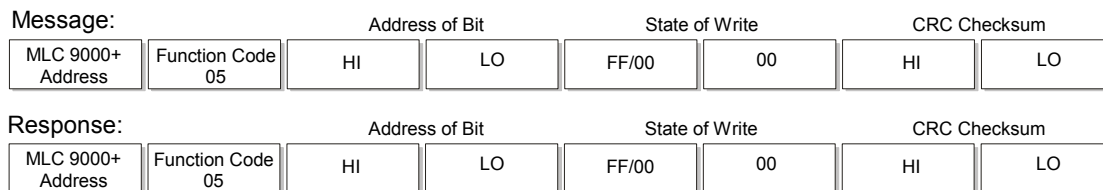

The “Address of Bit” bytes specify the bit to which the binary value is to be written. The most significant “State to Write” byte is 0xFF if the bit is to be set (1) and 0x00 if the bit is to be reset (0). Note that the response normally returns the same data as that contained in the message.

5.3.4 Preset Single Register (Function 06)

This function writes two bytes to a specified word address. The format is:

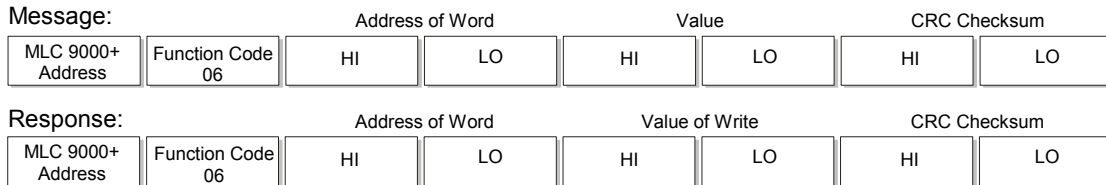

Note that the response normally returns the same data as that contained in the message.

5.3.5 Loopback Diagnostic Test (Function 08)

In this function, the function code byte is followed by a two-byte diagnostic code and two bytes of data:

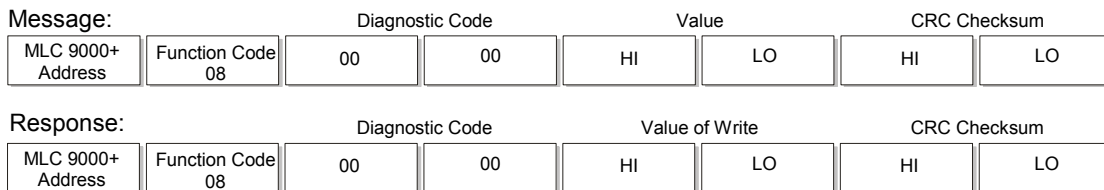

The only diagnostic code supported is 0x00. Note that the response is normally an exact echo of the Message.

5.3.6 Force Multiple Coils (Function 0x0F)

This function writes consecutive bits to the specified address range. Its format is:

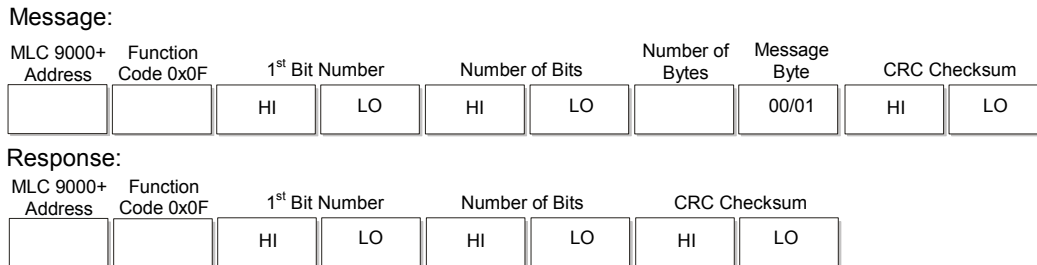

The MLC 9000+ limits the number of bits that may be written to 1. To set the addressed bit ON (1), Bit 0 in the Message Byte = 1; to set the addressed bit OFF (0), Bit 0 = 0. To write multiple bits, consider using Preset Single Register (Function 06).

5.3.7 Preset Multiple Registers (Function 0x10)

This function writes consecutive two-byte values to the specified address range. Its format is:

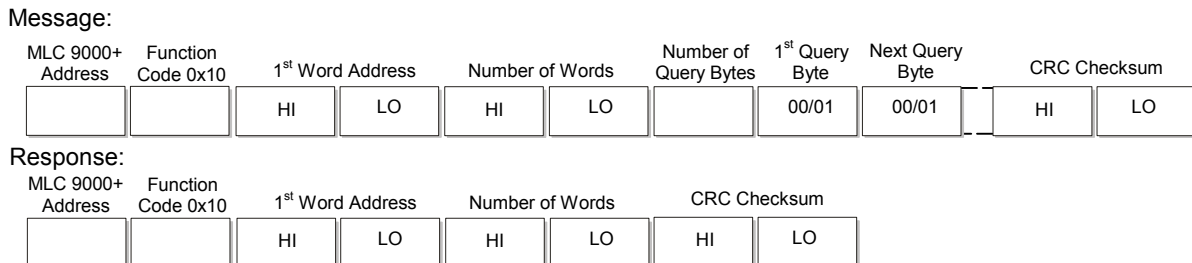

The MLC 9000+ system limits the number of consecutive words to be written to 64 (128 Message Bytes). It is not possible to write across instance boundaries.

5.3.8 Read/Write Multiple Registers (Function 0x17)

This function reads and writes consecutive two-byte values to the specified address range. Its format is:

Message:

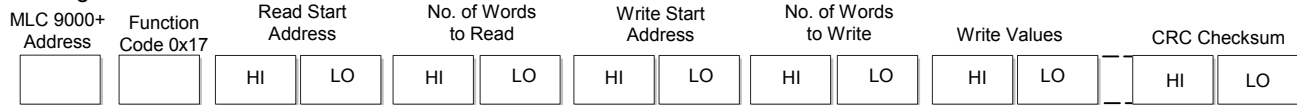

Response:

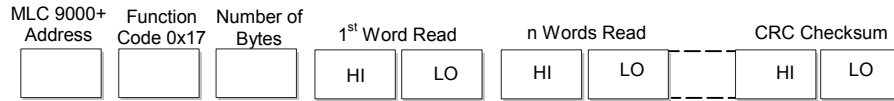

The n number of words in the response is equal to the quantity of words to be read.

The Read data assembly starts at (0x600) 1536 and the Write data assembly starts at (0x700) 1792

5.3.9 Exception Responses

When a message is received which the Bus Communications Module cannot interpret, an exception response is returned in the following format:

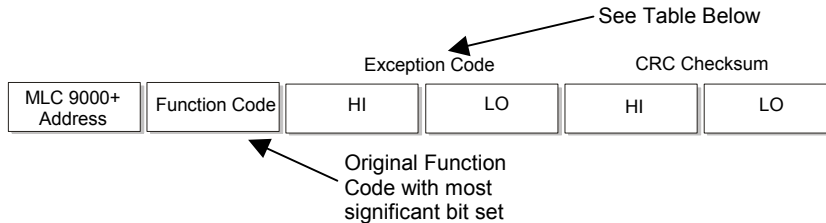

The exception code may be one of the following:

Code	Error Condition	Interpretation
00	Not Used	None
01	Illegal Function	Function Number out of range
02	Illegal Data Address	Parameter Number out of range or not supported.
03	Illegal Data Value	Attempt to write invalid data/required action not executed. This exception will also be returned if reading/writing over instance boundaries.

If multiple exceptions occur as a result of a Function, only the first exception code will be returned.

5.4 Using the Data Assemblies

The data assemblies for a MODBUS connection are used to bring parameters together for more efficient communications. There are two types of data assembly, read and write. The read data assembly is for parameters that are to be transferred from the MLC 9000+ to the supervisory system such as the process variable and alarm states. The write data assembly is for parameters that are to be transferred from the supervisory system to the MLC 9000+ such as the setpoint and alarm values. The read and write data assemblies consist of a total of 256 words that can be configured to contain any of the parameters in the MLC 9000+ system. One parameter occupies 1 word space. If one bit parameter is placed in a word space then it will occupy that complete word although up to 16 bit parameters can be placed in that same word.

Note: In all cases it is recommended that the data assemblies are used for accessing commonly used parameters.

Using the MLC 9000+ Workshop software the read and write data assemblies are populated. Navigate to the data assemblies screen, in the left hand column is a list of all the parameters available in the MLC 9000+ and on the right are the two configurable data assemblies.

To add a parameter to the data assemblies drag it from the left column and drop it into a spare data assembly slot.

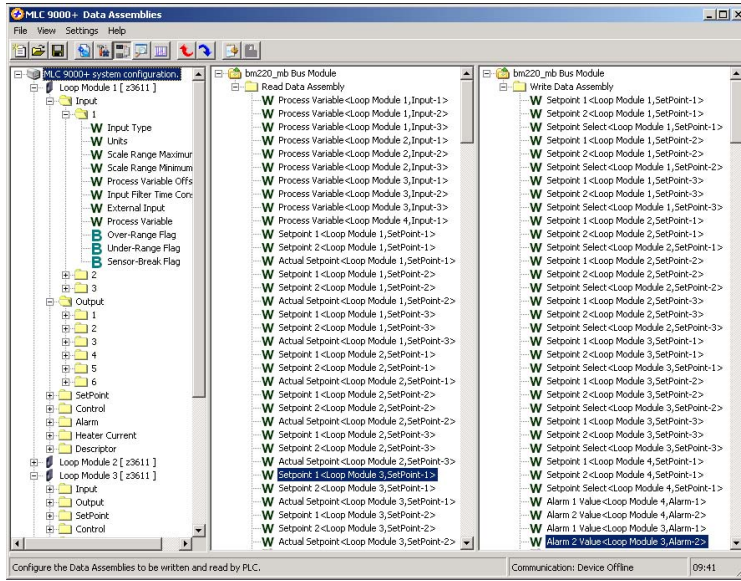

Once the data assemblies have been populated a summary of the parameters added can be shown by selecting the  icon from the menu bar. In this summary each parameter is listed along with its MODBUS address in decimal and hexadecimal.

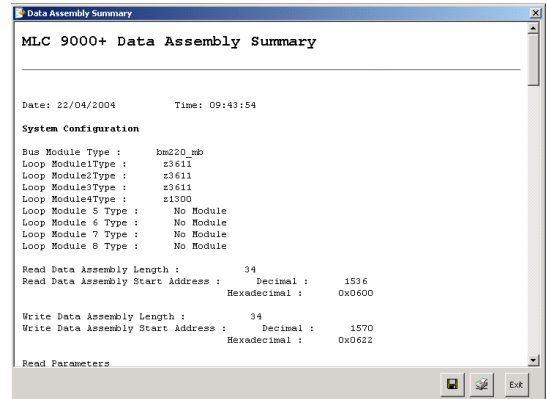

To read a parameter at data assembly space 3 and write 56 to a parameter at data assembly space 128 in a Bus Module at MODBUS address 96 (0x60) the MODBUS function 0x17 can be used (all values are in hexadecimal).

Bus Module Address	Function Code	Read Start Address	No. of Words to Read	Write Start Address	No. of Words to Write	Write Values	CRC Checksum
60	17	06	03	07	80	00 38	HI LO

Note: There can be a maximum of 8 bit words, if more are required please refer to section 4.8.5

Note: The total number of words in the data assembly is 256. The summation of the read and write words must not exceed 256 words.

5.5 Addressing Individual Parameters

The Bus Module is given a base address during configuration the MLC 9000+ system then occupies this and up to eight further addresses above the base address. Each Loop Module in an MLC 9000+ system is allocated an address relative to the base address as shown in the diagram below. For MODBUS Bus Modules with less than eight Loop Modules, it is recommended that the addresses of the vacant slots be reserved for future expansion. The Bus Communications Module will also accept global or broadcast commands (i.e. those addressed to all parts of the MODBUS network) with address 0.

Accessing parameters directly should only be used for set-up and diagnostic purposes. If messages are to be sent directly to the loop module then a gap of at least **300ms** should be left between each message.

If the Bus Module has the default base address of 96 (0x60) then the Loop Modules connected to it have the MODBUS addresses of:

- Loop Module 1 = 97 (0x61)
- Loop Module 2 = 98 (0x62)
- Loop Module 3 = 99 (0x63)
- Loop Module 4 = 100 (0x64)
- Loop Module 5 = 101 (0x65)
- Loop Module 6 = 102 (0x66)
- Loop Module 7 = 103 (0x67)
- Loop Module 8 = 104 (0x68)

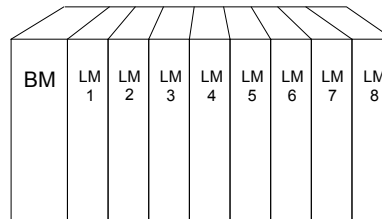

To read the process variable of Loop Module 3 Loop 1 the following message can be used (all values below are in hexadecimal).

Address	Function Code	Address of Process variable	Number of Parameters	CRC Checksum	
63	03	00	19	00	01
				HI	LO

The address of all the accessible parameters in the MLC 9000+ can be found in [Appendix A](#).

WARNING: If a parameter is mapped to the write data assembly then any changes directly to the parameter will not be implemented as the data assembly will over write the value.

5.6 Diagnostics and Fault Finding

If a malfunction occurs on the MODBUS interface to the Master Device, this can be investigated using the following procedure:

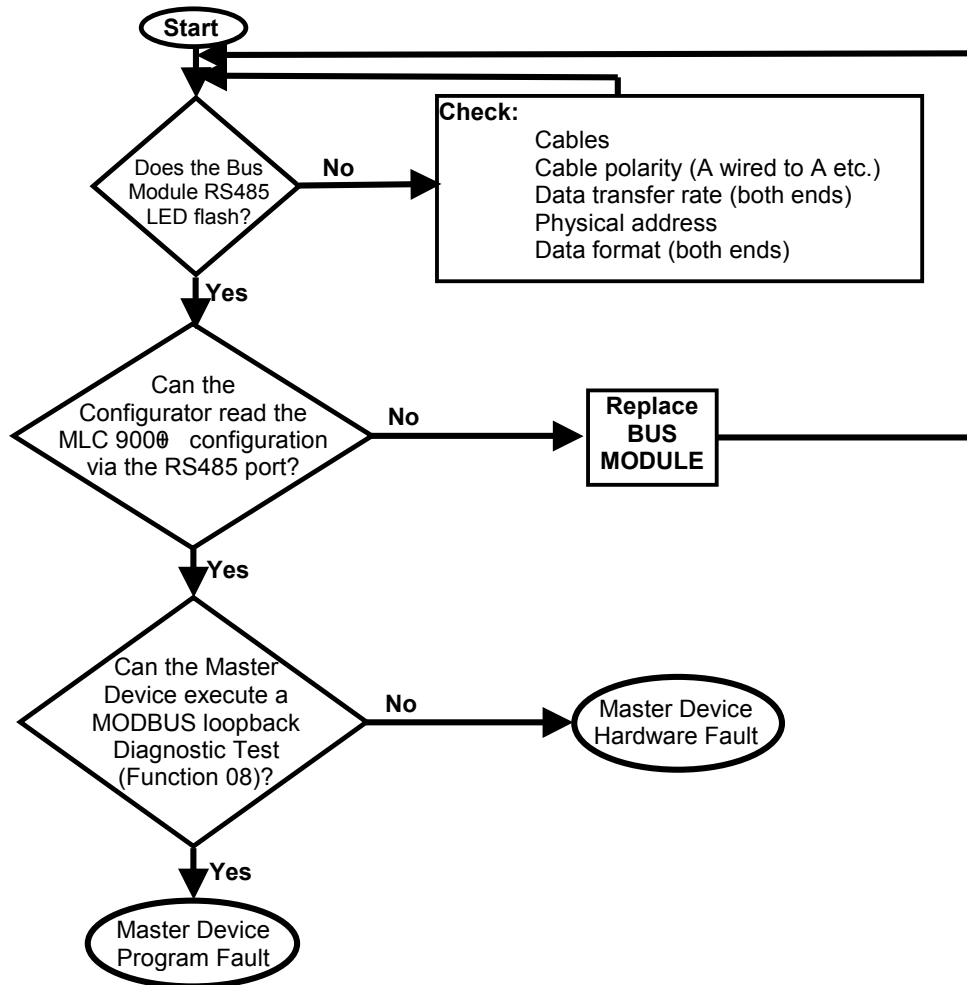

5.7 CRC Checksum Calculation

This is a 16-bit cyclic redundancy checksum. It is calculated in accordance with a formula which involves recursive division of the data by a polynomial, with the input to each division being the remainder of the results of the previous one.

The formula specifies that input is treated as a continuous bit-stream binary number, with the most significant bit being transmitted first. However, the transmitting device sends the least significant bit first.

According to the formula, the dividing polynomial is $2^{16} + 2^{15} + 2^2 + 1$ (0x18005), but this is modified in two ways:

- (i) Because the bit-order is reversed, the binary pattern is reversed also, making the MSB the rightmost bit, and
- (ii) Because only the remainder is of interest, the MSB (the right-most bit) may be discarded.

This means the polynomial has the value 0xA001. The CRC algorithm is as follows:

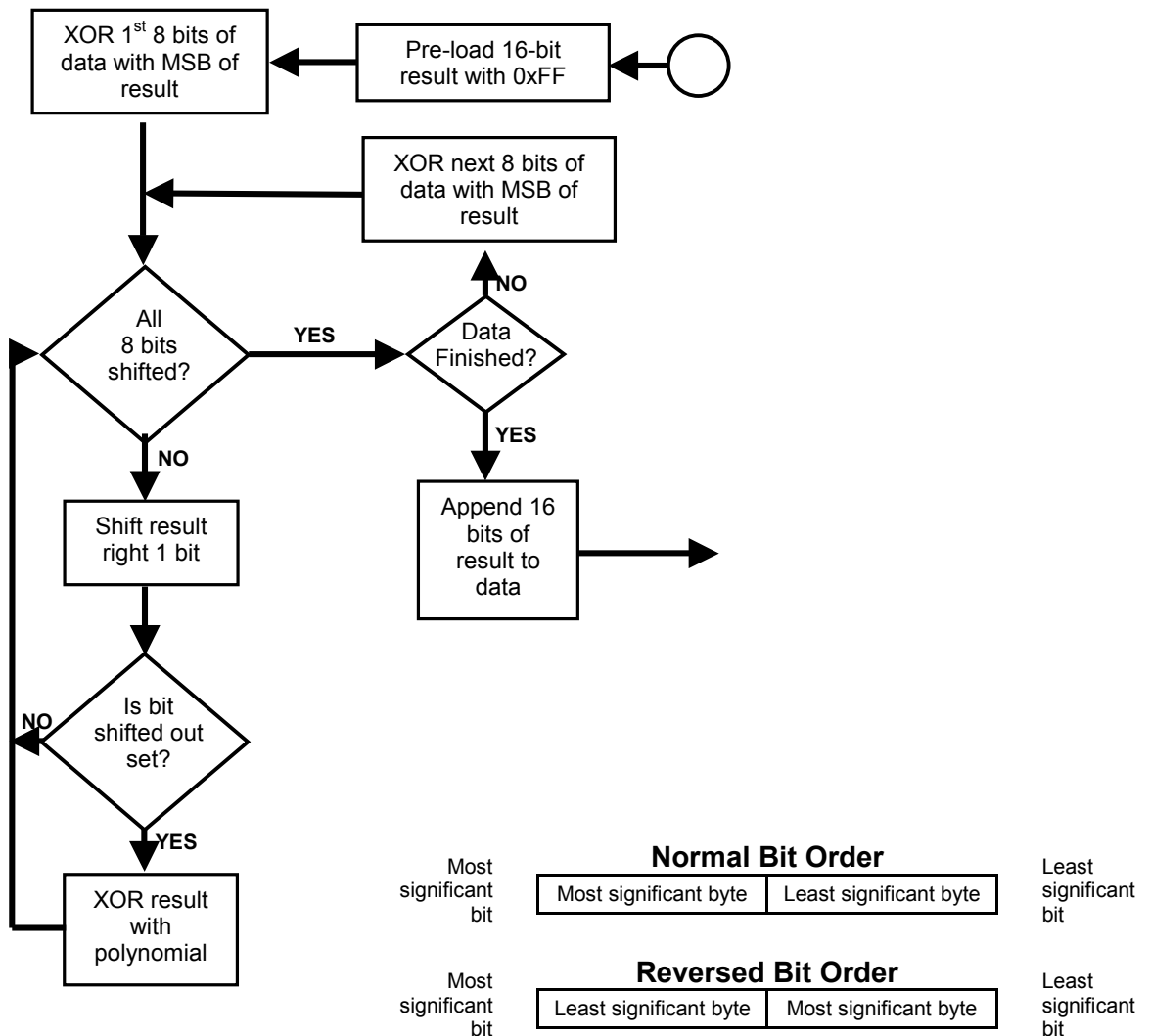

REVERSED BIT ORDER USED

6 OVERVIEW OF DeviceNet COMMUNICATIONS (BM230-DN)

6.1 Introduction

The MLC 9000+ System is connected to a DeviceNet master device via the DeviceNet port on the Bus Module. The Bus Module acts as a Class 2 Slave Device. More information on the DeviceNet standard can be found on the ODVA website www.odva.org.

NOTE 1: This section describes DeviceNet Communications for an MLC 9000+ equipped with a DeviceNet Bus Module.

NOTE 2: Unless otherwise specified, all numbers in this section are expressed in decimal form.

6.2 Interface Configuration

The DeviceNet interface is configured using the Configuration software MLC 9000+ system Tools. There are 3 parameters associated with interfacing the DeviceNet Bus Module to a DeviceNet network;

1. **Fieldbus Address:** This parameter sets the DeviceNet address of the Bus Module. This can be any value between 0 and 63. Default address is 63
2. **Fieldbus Data Rate:** This is the data rate at which the DeviceNet network communicates. The following data rates are supported by the MLC 9000+: 125kb, 250kb, 500kb
3. **Data Assemblies:** This is the user defined read and write data tables.

When any of the above parameters are changed the Bus Module requires a power cycle for the changes to take effect.

6.3 DeviceNet Messages

There are two types of DeviceNet message supported by the MLC 9000+ Bus Module:

- (a) **Input/Output Messages:** These provide special purpose communication paths between a data producing application and one or more consuming applications.
- (b) **Explicit Messages:** These provide typical request/response type communications.

6.3.1 Input/Output Messages (Data Assemblies)

Implicit messages communicate a parameter value or a command on a pre-arranged schedule. These provide special purpose communication paths between a data producing application and one or more consuming applications. The MLC 9000+ has a very large parameter set so use of a DeviceNet implicit connection for all parameters at once is impractical therefore the MLC 9000+ uses 2 configurable data assemblies, one for reading parameters and one for writing parameters. The read and write data assemblies consist of a total of 256 words that can be configured to contain any of the parameters in the MLC 9000+ system. One parameter occupies 1 word space. If one bit parameter is placed in a word space then it will occupy that complete word although up to 16 bit parameters can be placed in that same word. The read and the write data assemblies are configured using the MLC 9000+ configuration software by dragging and dropping the required parameter into the data assembly. Please refer to 4.11.1 Startup and Removal of loop modules for information on data assembly values in these two states.

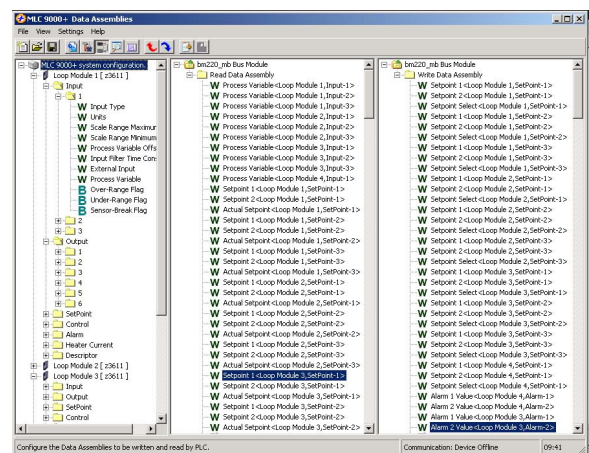

Note: There can be a maximum of 8 bit words, if more are required please refer to section 4.8.5

Note: The total number of words in the data assembly is 256. The summation of the read and write words must not exceed 256 words.

6.3.2 Explicit Messages

Explicit messages provide multi-purpose, point-to-point communication paths between two devices. They provide the typical request/response oriented network communications used to access single parameters.

The Explicit message format for the MLC 9000+ is mapped to the DeviceNet Explicit message as below:

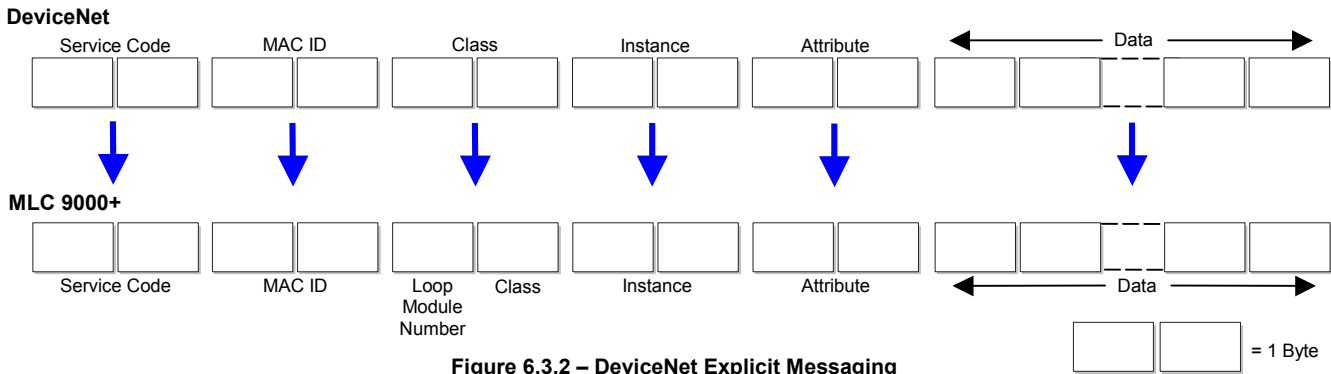

Figure 6.3.2 – DeviceNet Explicit Messaging

Service Code: The service codes determine a read or write operation. The DeviceNet Get (read) attribute service code is 0x0E. The DeviceNet Set (write) attribute service code is 0x10.

MAC ID: The MAC ID is the MLC 9000+ node address.

Class: The Class is made up of the Loop Module position number and the class of the parameter to be read, (the class of a parameter can be found in [appendix A](#)). The combination of the two parameters is then offset by 0x60 i.e. Loop 1 Class 1's DeviceNet equivalent is would be 0x71.

Example: The Loop Module position number represents the physical position of the Loop Module in the MLC 9000+ system. To read the PV of loop 1 of Loop Module 5 the class parameter would be 0x50 before the addition of the offset (The upper 4 bits of the byte is 0x5 (same as 5 decimal), and the lower 4 bits are 0x0). The class number for loop 1 PV can be found in [appendix A](#). When the offset of 0x60s added the DeviceNet class value becomes 0xB0.

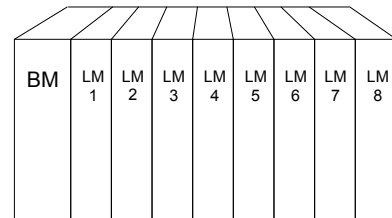

Instance: This is the instance number of the parameter to be read, which can be found in the parameter list section of this manual. There is no change required between the DeviceNet representation and the MLC 9000+. ([Appendix A](#))

Attribute: This is the parameter number which can be found in the parameter list section of this manual. There is no change required between the DeviceNet representation and the MLC 9000+. ([Appendix A](#))

Data: The data is the value to be written (not required for a read operation).

Warning: When using explicit messaging the master should wait **300ms** between receiving the response to a previous message and sending the next request. If messages are faster than 300ms then errors in the response may occur.

6.4 Creating the DeviceNet .eds file

In order to communicate via DeviceNet an .eds file needs to be created. This is done using the MLC 9000+ Workshop software.

Navigate to the data assemblies screen, in the left hand column is a list of all the parameters available in the MLC 9000+ and on the right are the two configurable data assemblies.

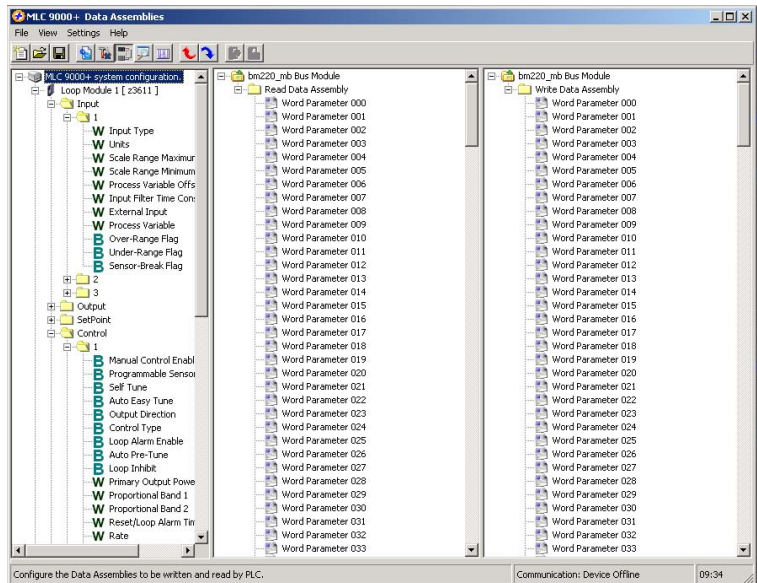

To add a parameter to the data assemblies drag it from the left column and drop it into a spare data assembly slot.

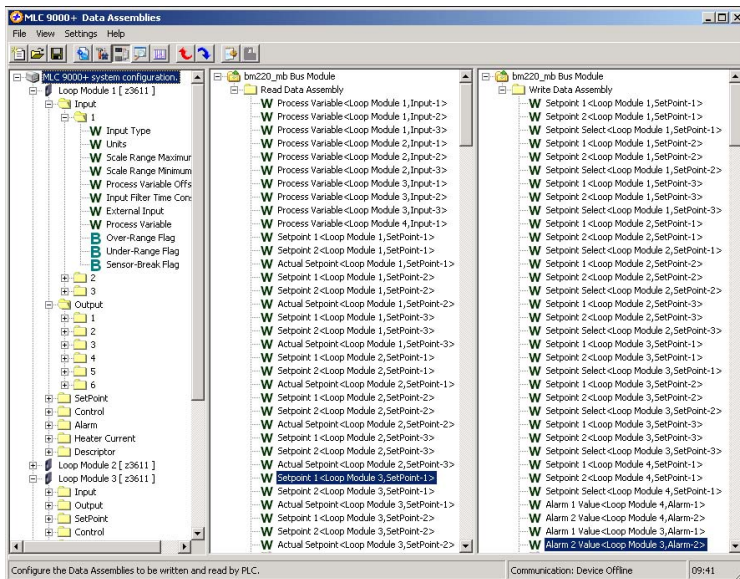

WARNING: To ensure correct communications both the read and write data assemblies require a minimum of 1 parameter to be included.

Once the data assemblies have been configured an .eds file can be created. MLC 9000+ Workshop generates this file once the data assemblies have been populated. Click on the create GSD/EDS icon  in the tool bar this will activate the create GSD/EDS wizard that will guide you through the creation of the .eds file.

Once the .eds file has been created it needs to be registered on the DeviceNet network. This procedure varies from one manufacturer to another so is not covered in this manual. Application notes are available for the most common DeviceNet master devices (PLC's) (contact your local MLC 9000+ supplier if more information is required).

Note: Any changes made to the configuration of the data assemblies a new .gsd file has to be created and imported into the master device.





7 OVERVIEW OF PROFIBUS COMMUNICATIONS (BM240-PB)

7.1 Introduction

PROFIBUS is a standard for communication in an industrial environment. The BM240-PB Bus Module allows the MLC 9000+ system to be directly connected to a PROFIBUS DP network. PROFIBUS DP is used for communications between field devices. When connected to a PROFIBUS DP network the MLC 9000+ acts as a PROFIBUS slave device. More information on the PROFIBUS standard can be found on the website www.profibus.com.

NOTE 1: It is assumed that this section is being read in support of a MLC 9000+ system equipped with a BM240-PB PROFIBUS Bus Module

NOTE 2: Unless otherwise specified, all numbers in this section are expressed in decimal form.

7.2 Interface Configuration

The PROFIBUS interface of the Bus Module is configured using the MLC 9000+ configuration software. There are 4 parameters associated with interfacing the PROFIBUS Bus Module to a PROFIBUS network;

1. **Address:** This parameter sets the PROFIBUS address of the Bus Module. This can be any value between 0 and 126. Default address is 126.
2. **Byte Order:** This parameter controls the order in which multi-byte values arranged in the data packets are transmitted on the bus. This can be low then high byte or high then low byte. Default is high then low byte.
3. **Data Rate:** This is the data rate at which the PROFIBUS network communicates. This is auto-detected by the PROFIBUS Bus Module. The PROFIBUS interface can communicate at the following data rates; 9.6kbps, 19.2kbps, 45.45kbps, 93.75kbps, 187.5kbps, 500kbps, 1.5Mbps, 3Mbps, 6Mbps, 12Mbps.
4. **Data Assemblies:** This is the user defined read and write data tables.

When any of the above parameters are changed the Bus Module requires a power cycle for the changes to take effect.

7.3 PROFIBUS Messages

There are two types of PROFIBUS message supported by the MLC 9000+ Bus Module:

- (a) **Cyclic Messages:** These provide special purpose communication paths between a data producing application and one or more consuming applications.
- (b) **Acyclic Messages:** These provide typical request/response type communications.

7.3.1 Cyclic Messages (Data Assemblies)

Cyclic messages communicate a parameter value or a command on a pre-arranged schedule. These provide special purpose communication paths between a data producing application and one or more consuming applications. The MLC 9000+ has a very large parameter set so use of a PROFIBUS cyclic connection for all parameters at once is impractical, therefore the MLC 9000+ uses 2 configurable data assemblies one for reading parameters and one for writing parameters. The read and write data assemblies consist of a total of 256 words that can be configured to contain any of the parameters in the MLC 9000+ system. One parameter occupies 1 word space. If one bit parameter is placed in a word space then it will occupy that complete word although up to 16 bit parameters can be placed in that same word. The read and the write data assemblies are configured using the MLC 9000+ Workshop software. Please refer to 4.11.1 Startup and Removal of loop modules for information on data assembly values in these two states.

Note: There can be a maximum of 8 bit words, if more are required please refer to section 4.8.5

Note: The total number of words in the data assembly is 256. The summation of the read and write words must not exceed 256 words.

7.3.2 Acyclic Messages

Acyclic Messaging is currently not supported by the MLC 9000+.

7.4 Official approved Profibus GSD File

The Profibus BCM has official Profibus approval from the Profibus test centre. When there is a requirement of use of the BCM as an approved item a specific GSD file must be used, this is available from our website. www.westinstruments.com

The Profibus Approved version of the MLC9000+ has vendor ID number 0x0AA3, the non approved version has vendor ID 0x06A7. This is identified in the GSD file by the prefix "Ident_number". Currently the MLC9000+ configuration software generates non-approved GSD files using the non-approved vendor ID. Consequently if the generated GSD file is to be used with an approved MLC9000+ it is necessary to edit the GSD file manually. If you are not sure how to do this an application note describing the necessary steps can be downloaded from our web site.

7.5 Creating the PROFIBUS .gsd/gse file

In order to communicate via PROFIBUS a .gsd/gse file needs to be created. This can also be done using the MLC 9000+ configuration software.

Navigate to the data assemblies screen, in the left hand column is a list of all the parameters available in the MLC 9000+ and on the right are the two configurable data assemblies.

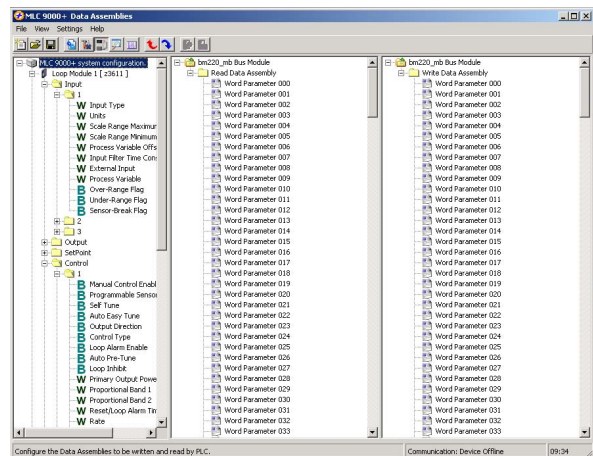

To add a parameter to the data assemblies drag it from the left column and drop it into a spare data assembly slot.

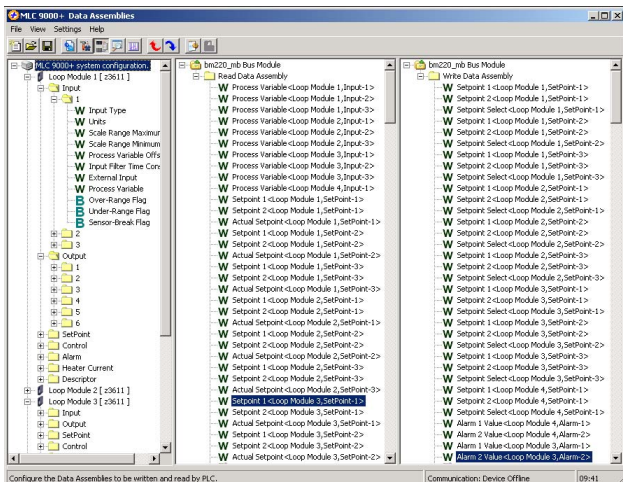

WARNING: To ensure correct communications both the read and write data assemblies require a minimum of 1 parameter to be included.

Once the data assemblies have been configured an .gsd file can be created. MLC 9000+ Workshop generates this file once the data assemblies have been populated. Click on the create

GSD/EDS icon  in the tool bar this will activate the create GSD/EDS wizard that will guide you through the creation of the .gsd file.

Once the .gsd/gse file has been created it needs to be registered on the PROFIBUS network. This procedure varies from one manufacturer to another so is not covered in this manual.

Application notes are available for the more common PROFIBUS master devices (PLC's). (contact your local MLC 9000+ supplier for more information)

Note: Any changes made to the configuration of the data assemblies a new .gsd file has to be created and imported into the master device.

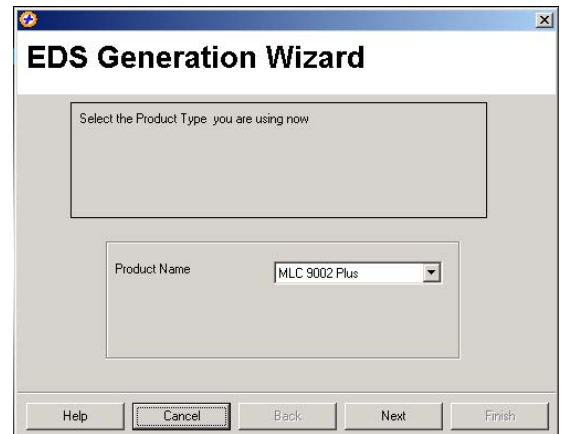

8 OVERVIEW OF Ethernet/IP COMMUNICATIONS (BM250-EI)

8.1 Introduction

The BM250-EI Bus Module allows the MLC 9000+ system to be directly connected to an Ethernet/IP network. Ethernet/IP uses the standard Ethernet and TCP/IP technologies with an application layer called Control and information protocol (CIP), this is the same application layer used by DeviceNet so many of the functions are the same.

NOTE 1: It is assumed that this section is being read in support of a MLC 9000+ system equipped with a BM250-EI Bus Module Configured for Ethernet/IP Communications.

NOTE 2: Unless otherwise specified, all numbers in this section are expressed in decimal form.

8.2 Interface Configuration

The Ethernet/IP interface of the Bus Module is configured using the MLC 9000+ Configuration software. There are 3 parameters associated with interfacing the Ethernet/IP Bus Module to an Ethernet/IP network;

1. **IP Address:** This parameter defines the IP address of the MLC 9000+.
2. **MAC Address:** This parameter defines the MAC address of the MLC 9000+ (Read Only)
3. **Data Assemblies:** This is the user defined read and write data tables.

When any of the above parameters are changed the Bus Module requires a power cycle for the changes to take effect.

8.3 Ethernet/IP Messages

There are two types of Ethernet/IP message supported by the MLC 9000+ Bus Module:

- (c) **Input/Output Connection:** These provide special purpose communication paths between a data producing application and one or more consuming applications.
- (d) **Explicit Messages:** These provide typical request/response type communications.

8.3.1 Input/Output Connection (Data Assemblies)

Input/Output connections communicate a parameter value or a command on a pre-arranged schedule. These provide special purpose communication paths between a data producing application and one or more consuming applications. The MLC 9000+ has a very large parameter set so use of an Ethernet/IP I/O connection for all parameters at once is impractical therefore the MLC 9000+ uses 2 configurable data assemblies, one for reading parameters and one for writing parameters. The read and write data assemblies consist of a total of 256 words that can be configured to contain any of the parameters in the MLC 9000+ system. One parameter occupies 1 word space. If one bit parameter is placed in a word space then it will occupy that complete word although up to 16 bit parameters can be placed in that same word. The read and write data assemblies are configured using the MLC 9000+ configuration software by dragging and dropping the required parameter into the data assembly. Please refer to 4.11.1 Startup and Removal of loop modules for information on data assembly values in these two states.

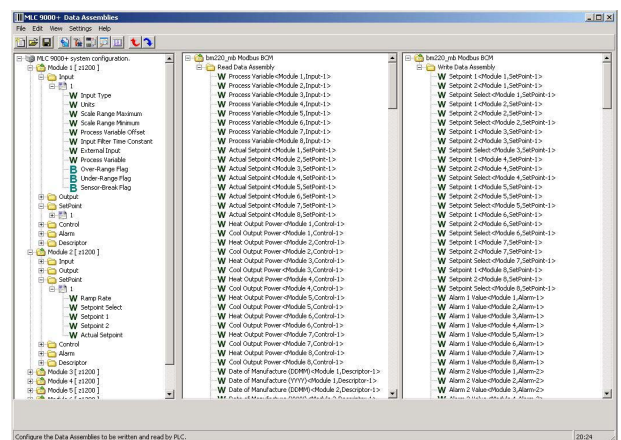

Note: There can be a maximum of 8 bit words, if more are required please refer to section 4.8.5

Note: The total number of words in the data assembly is 256. The summation of the read and write words must not exceed 256 words.

8.4 Creating the Ethernet/IP .eds file

In order to communicate via Ethernet/IP an .eds file needs to be created. This is done using the MLC 9000+ Workshop software.

Navigate to the data assemblies screen, in the left hand column is a list of all the parameters available in the MLC 9000+ and on the right are the two configurable data assemblies.

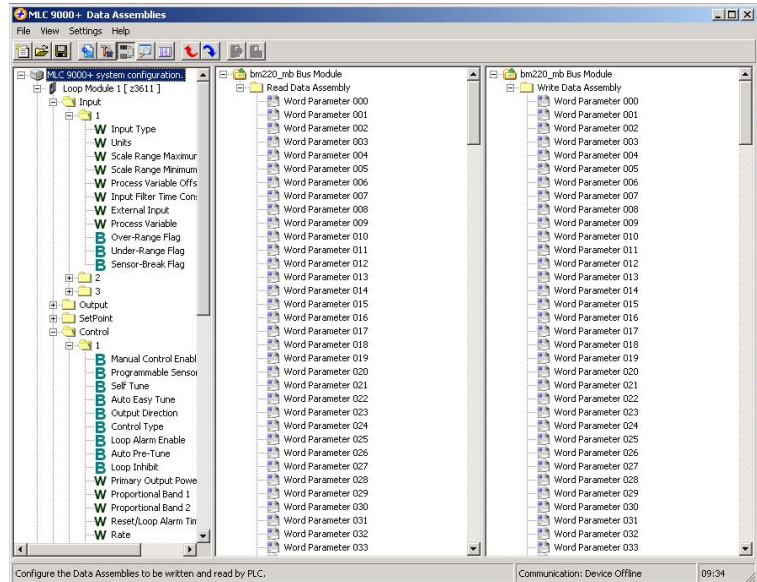

To add a parameter to the data assemblies drag it from the left column and drop it into a spare data assembly slot.

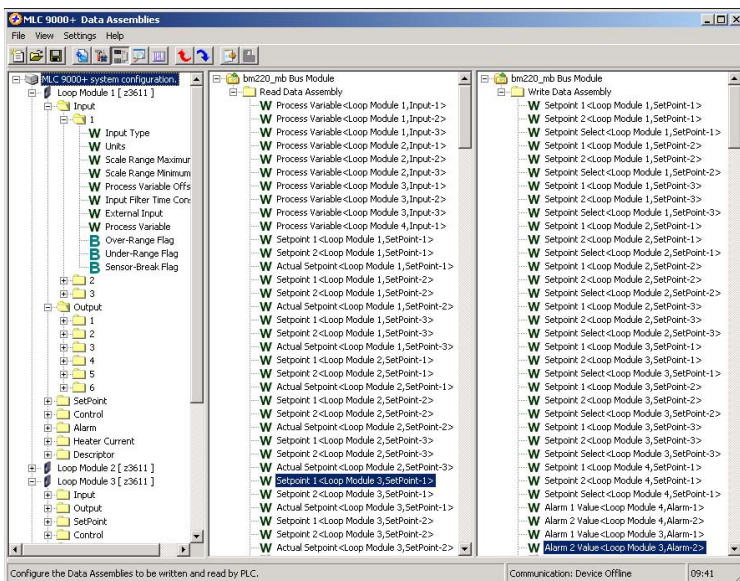

WARNING: To ensure correct communications both the read and write data assemblies require a minimum of 1 parameter to be included.

Once the data assemblies have been configured an .eds file can be created. MLC 9000+ Workshop generates this file once the data assemblies have been populated.

Click on the create GSD/EDS icon  in the tool bar this will activate the create GSD/EDS wizard that will guide you through the creation of the .eds file.

Once the .eds file has been created it needs to be registered on the Ethernet/IP network. This procedure varies from one manufacturer to another so is not covered in this manual. Application notes are available for the most common Ethernet/IP master devices (PLC's) (contact your local MLC 9000+ supplier if more information is required).

Note: Any changes made to the configuration of the data assemblies a new .gsd file has to be created and imported into the master device.

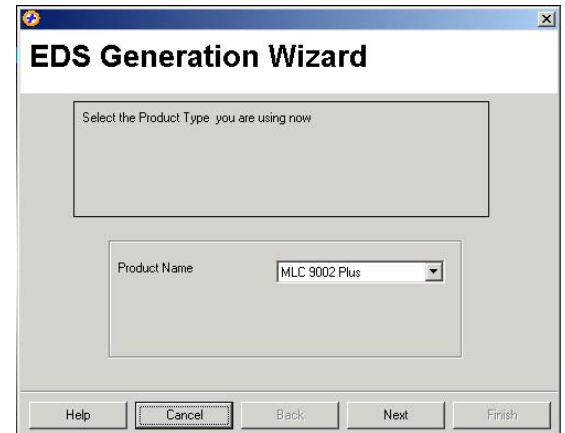



9 OVERVIEW OF MODBUS/TCP COMMUNICATIONS (BM250-MT)

9.1 Introduction

MODBUS/TCP is a variant of the MODBUS family of communication protocols. MODBUS/TCP covers the transmission of the MODBUS protocol over an 'intranet' or 'internet' environment using the TCP/IP protocols. The BM250-MT Bus Module allows the MLC 9000+ system to be directly connected to a MODBUS/TCP network. More information can be found on www.modbus.org website.

NOTE 1: It is assumed that this section is being read in support of a MLC 9000+ system equipped with a BM250-MT Bus Module Configured for MODBUS/TCP Communications.

NOTE 2: Unless otherwise specified, all numbers in this section are expressed in decimal form.

9.2 Interface Configuration

The MODBUS/TCP interface of the Bus Module is configured using the Configuration software MLC 9000+ system tools. There are 4 parameters associated with interfacing the MODBUS/TCP Bus Module to an MODBUS/TCP network;

1. **IP Address:** This parameter defines the IP address of the MLC 9000+.
2. **MODBUS Port:** This parameter defines the MODBUS port address of the MLC 9000+. This can be set in the range 1 – 247 (default 96)
3. **MAC Address:** This parameter defines the MAC address of the MLC 9000+ (read only).
4. **Data Assemblies:** This is the user defined read and write data tables.

When any of the above parameters are changed the Bus Module requires a power cycle for the changes to take effect.

9.3 MODBUS/TCP Functions Supported

Code (hex)	MODBUS Function	Meaning
01 or 02	Read Coil/Input Statue	Read input /output status bits at given address
03 or 04	Read Holding/Input Register	Read current binary value of data bytes at given address
05	Force Single Coil	Write a single binary bit to the specified word address
06	Pre-set Single Register	Write two bytes to the specified address
08	Diagnostics	Used only for loopback test
0x0F	Force Multiple Coils	Write consecutive bits to the specified address range.
0x10	Pre-set Multiple Registers	Write consecutive two-byte values to the specified address range.
0x17	Read/Write Multiple Registers	Read and Write multiple Registers at the same time.

More detail on each MODBUS/TCP function is given in the following Subsections.

9.3.1 Read Coil/Input Status (Function 01/02)

Either Function 01 or Function 02 may be used interchangeably to read the content of the status bits at the specified bit address. The format is:

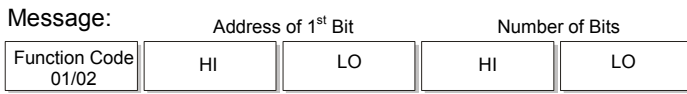

In the response, the “No. of Bytes” indicates the number of data bytes read from the addressed Loop Controller Module (e.g. if 16 bits are returned, the count will be 2). The maximum number of bits that can be read is 32. The first bit read is the least significant bit of the first eight bits requested.

Note: These function codes are not supported for accessing information from the BUS Control Module

9.3.2 Read Holding/Input Registers (Function 03/04)

Either Function 03 or Function 04 may be used interchangeably to read the current binary value of the data at the specified word address. The format is:

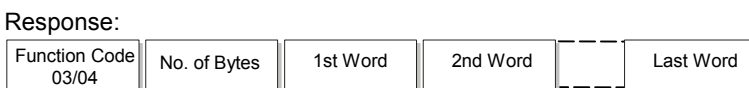
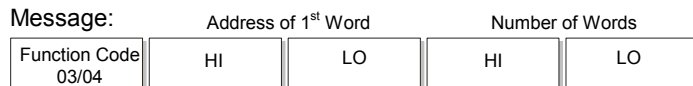

In the response, the “No. of Bytes” indicates the number of data bytes read from the Loop Controller Module e.g. if five words (10 bytes) are read, the count will be 0x0A. The maximum number of words which can be read is 64 returned in 128 bytes.

9.3.3 Force Single Coil (Function 05)

This function writes a single binary value to the specified slave bit address. The format is:

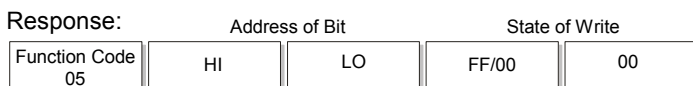
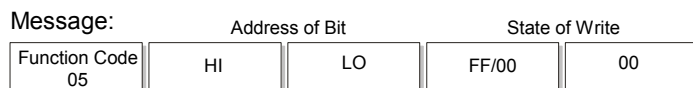

The “Address of Bit” bytes specify the bit to which the binary value is to be written. The most significant “State to Write” byte is 0xFF if the bit is to be set (1) and 0x00 if the bit is to be reset (0). Note that the response normally returns the same data as that contained in the message.

9.3.4 Preset Single Register (Function 06)

This function writes two bytes to a specified word address. The format is:

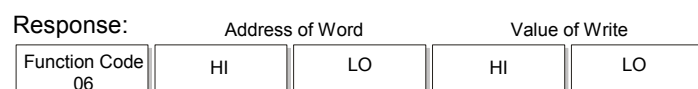
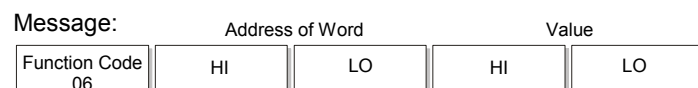

Note that the response normally returns the same data as that contained in the message.

9.3.5 Loopback Diagnostic Test (Function 08)

In this function, the function code byte is followed by a two-byte diagnostic code and two bytes of data:

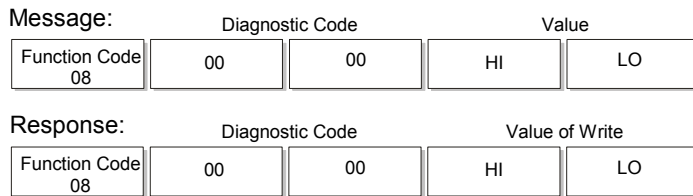

The only diagnostic code supported is 0x00. Note that the response is normally an exact echo of the Message.

9.3.6 Force Multiple Coils (Function 0x0F)

This function writes consecutive bits to the specified address range. Its format is:

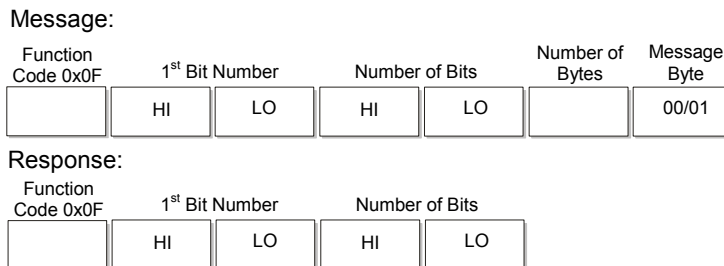

The MLC 9000+ limits the number of bits that may be written to 1. To set the addressed bit ON (1), Bit 0 in the Message Byte = 1; to set the addressed bit OFF (0), Bit 0 = 0. To write multiple bits, consider using Preset Single Register (Function 06).

9.3.7 Preset Multiple Registers (Function 0x10)

This function writes consecutive two-byte values to the specified address range. Its format is:

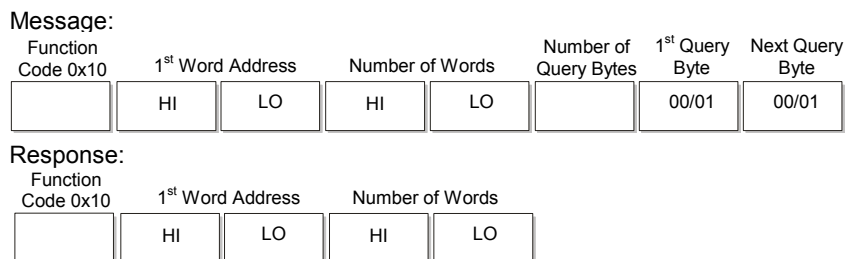

The MLC 9000+ system limits the number of consecutive words to be written to 64 (128 Message Bytes). It is not possible to write across instance boundaries.

9.3.8 Read/Write Multiple Registers (Function 0x17)

This function reads and writes consecutive two-byte values to the specified address range. Its format is:

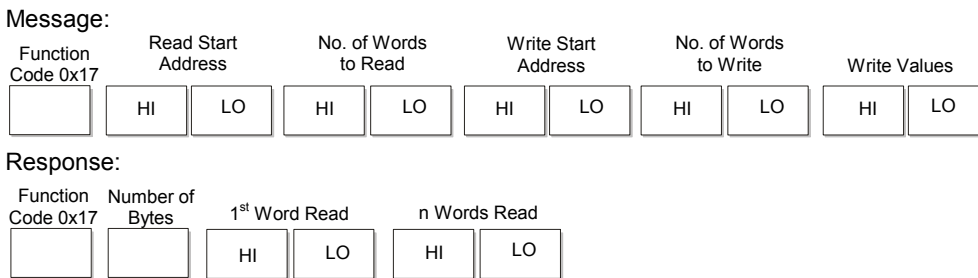

The n number of words in the response is equal to the quantity of words to be read.

The Read data assembly starts at (0x600) 1536 and the Write data assembly starts at (0x700) 1792

9.3.9 Exception Responses

When a message is received which the Bus Communications Module cannot interpret, an exception response is returned in the following format:

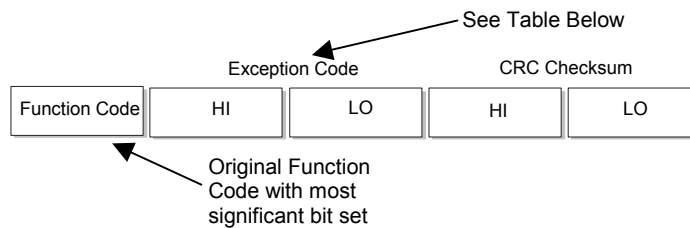

The exception code may be one of the following:

Code	Error Condition	Interpretation
00	Not Used	None
01	Illegal Function	Function Number out of range
02	Illegal Data Address	Parameter Number out of range or not supported.
03	Illegal Data Value	Attempt to write invalid data/required action not executed. This exception will also be returned if reading/writing over instance boundaries.
04	Server Failure	The server failed during the execution.
05	Acknowledge	The server accepted the service invocation but the service requires a relatively long time to execute. The server therefore returns only an acknowledgement of the service invocation receipt.
06	Server Busy	The server was unable to accept the MODBUS Request.

If multiple exceptions occur as a result of a Function, only the first exception code will be returned.

9.4 Using the Data Assemblies

The data assemblies for a MODBUS/TCP connection are used to bring parameters together for more efficient communications. There are two types of data assembly, read and write. The read data assembly is for parameters that are to be transferred from the MLC 9000+ to the supervisory system such as the process variable and alarm states. The write data assembly is for parameters that are to be transferred from the supervisory system to the MLC 9000+ such as the setpoint and alarm values. The read and write data assemblies consist of a total of 256 words that can be configured to

contain any of the parameters in the MLC 9000+ system. One parameter occupies 1 word space. If one bit parameter is placed in a word space then it will occupy that complete word although up to 16 bit parameters can be placed in that same word.

Note: There can be a maximum of 8 bit words, if more are required please refer to section 4.8.5

Note: In all cases it is recommended that the data assemblies are used for accessing commonly used parameters.

Using the MLC 9000+ Workshop software the read and write data assemblies are populated. Navigate to the data assemblies screen, in the left hand column is a list of all the parameters available in the MLC 9000+ and on the right are the two configurable data assemblies.

To add a parameter to the data assemblies drag it from the left column and drop it into a spare data assembly slot.

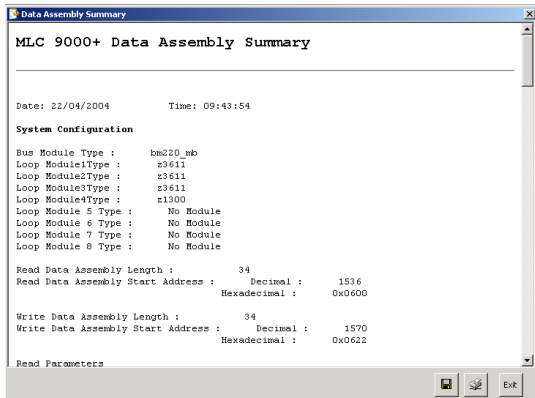
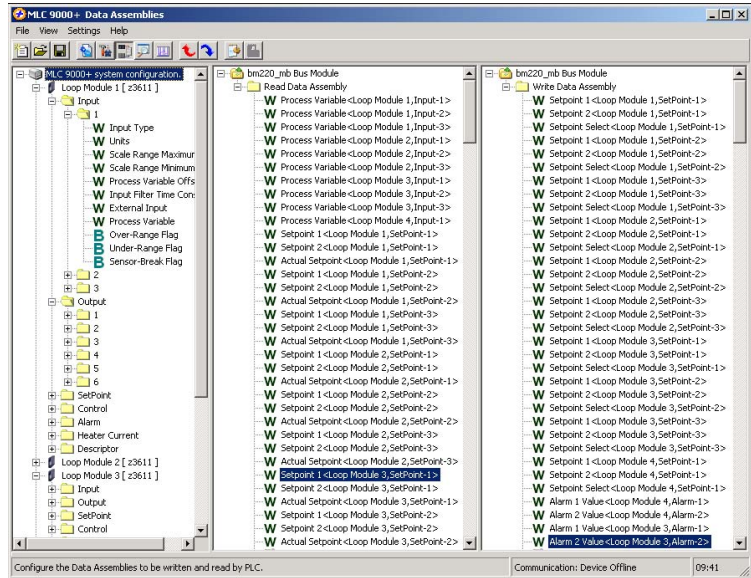

Once the data assemblies have been populated a summary of the parameters added can be shown by selecting the  icon from the menu bar. In this summary each parameter is listed along with its MODBUS address.

To read a parameter at data assembly space 3 and write 56 to a parameter at data assembly space 128 in a Bus Module, MODBUS/TCP function 0x17 can be used (all values are in hexadecimal).

Function Code	Read Start Address		No. of Words to Read		Write Start Address		No. of Words to Write		Write Values	
17	06	03	00	01	06	80	00	01	00	38

Note: The *total* number of words in the data assembly is 256. The summation of the read and write words must not exceed 256 words.

9.5 Addressing Individual Parameters

The Bus Module is given a base address (MODBUS port) during configuration, the MLC 9000+ system then occupies this and up to eight further addresses above the base address. Each Loop Module in an MLC 9000+ system is allocated an address relative to the base address as shown in the diagram below. For MODBUS/TCP Bus Modules with less than eight Loop Modules it is recommended that the addresses of the vacant slots be reserved for future expansion.

If the Bus Module has the default base address of 96 (0x60) then the Loop Modules connected to it have the MODBUS port addresses of:

Loop Module 1 = 97	(0x61)	Loop Module 5 = 101	(0x65)
Loop Module 2 = 98	(0x62)	Loop Module 6 = 102	(0x66)
Loop Module 3 = 99	(0x63)	Loop Module 7 = 103	(0x67)
Loop Module 4 = 100	(0x64)	Loop Module 8 = 104	(0x68)

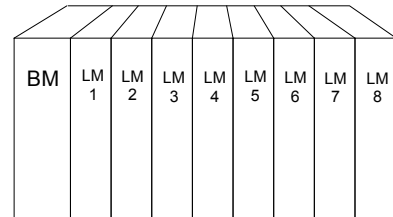

In all applications the Data Assemblies should be used for continuous communication and direct access to the modules should be restricted for configuration and diagnostics. When directly accessing the loop modules an inter-message gap of **300ms** should be left.

When accessing many loop parameters directly a pause in communications may be observed, this pause is due to the MLC 9000+ Bus module requiring time to perform essential housekeeping tasks.

This pause in communications can be misinterpreted by some master devices as an error in communications, however the TCP layer of the MODBUS/TCP protocol handles this pause and no information is lost.

To read the process variable of Loop Module 3 Loop 1 the following message can be used (all values are in hexadecimal).

Address	Function Code	Address of Process variable	Number of Parameters
63	03	00	19
			00
			01

The address of all the editable parameters in the MLC 9000+ can be found in [Appendix A](#).

WARNING: If a parameter is mapped to the write data assembly then any changes written directly to the parameter will not be implemented as the data assembly will over write the value.

APPENDIX A PARAMETER ADDRESSES

The Bus Module of the MLC 9000+ system has two communication ports, the first is used to communicate with a PC for configuration and the second is a fieldbus port for connection to a PLC, HMI or other such supervisory systems. The following contains tables of the parameters in the MLC 9000+ that can be read and written to via the fieldbus port of the Bus Module. The tables are used as follows:

The **Ref. page** column indicates the page containing the functional description of each parameter (Section 4).

The **fieldbus parameter** columns give the Class, Instance and Parameter numbers:

Class defines the category of parameter accessed (e.g. input, output, setpoint, etc...).

Instance specifies which example of class is accessed (e.g. output 1, output 2, etc...)

Parameter defines the parameter to be accessed for that Class and Instance. Parameter numbers are expressed as offset addresses from the base address of the instance. Bits within words are identified by the notation n.m, where n is the word offset and m is the bit number within the word. Bit-addressable parameters are also identified by their bit offset address from the base address of the instance.

The class, instance and parameter numbers are used by the supported communication protocols to access all available parameters in the MLC 9000+.

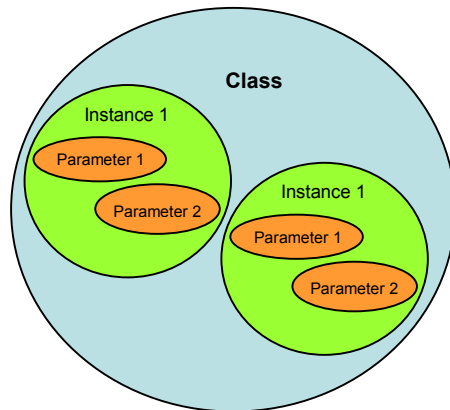

The **Type** column indicates access type allowed (R/O = Read Only, R/W = Read/Write, W/O = Write Only).

The **Pre-calculated MODBUS parameter address** columns show the decimal and hexadecimal representation of the MODBUS parameter address. This has been calculated from the class, instance and parameter for your convenience.

Note: Different module variants may not support all parameters listed in this section.

A1 Input Parameters

A1.1 Input 1 Parameters

Pre-calculated MODBUS Parameter Address				Name	Type	Fieldbus Parameter Idents				Ref. Page
Decimal		Hexadecimal				Class	Instance	Parameter		
Bit	Word	Bit	Word					Bit	Word	
	1		0001	Input Type & Range	R/W	00	0		1	4-2
	2		0002	Units	R/W (T/C & RTD inputs) R/O (DC inputs)	00	0		2	4-2
	3		0003	Scale Range Maximum	R/W	00	0		3	4-3
	4		0004	Scale Range Minimum	R/W	00	0		4	4-3
	5		0005	Process Variable Offset	R/W	00	0		5	4-1
	6		0006	Input Filter Time Constant	R/W	00	0		6	4-1
	24		0018	External Input Value	R/W	00	0		24	4-4
	25		0019	Process Variable	R/O	00	0		25	4-1
16	26	0010	001A	Over-range Flag	R/O	00	0	16	26.0	4-1
17	26	0011	001A	Under-range Flag	R/O	00	0	17	26.1	4-2
18	26	0012	001A	Sensor Break Flag	R/O	00	0	18	26.2	4-2

A1.2 Input 2 Parameters

Applicable only to module variants Z3611, Z3621, Z3651, Z4610, Z4620 and Z4660

Pre-calculated MODBUS Parameter Address				Name	Type	Fieldbus Parameter Idents				Ref. Page
Decimal		Hexadecimal				Class	Instance	Parameter		
Bit	Word	Bit	Word					Bit	Word	
	33		0021	Input Type & Range	R/W	00	1		1	4-2
	34		0022	Units	R/W (T/C & RTD inputs) R/O (DC inputs)	00	1		2	4-2
	35		0023	Scale Range Maximum	R/W	00	1		3	4-3
	36		0024	Scale Range Minimum	R/W	00	1		4	4-3
	37		0025	Process Variable Offset	R/W	00	1		5	4-1
	38		0026	Input Filter Time Constant	R/W	00	1		6	4-1
	56		0038	External Input Value	R/W	00	1		24	4-4
	57		0039	Process Variable	R/O	00	1		25	4-1
48	58	0030	003A	Over-range Flag	R/O	00	1	16	26.0	4-1
49	58	0031	003A	Under-range Flag	R/O	00	1	17	26.1	4-2
50	58	0032	003A	Sensor Break Flag	R/O	00	1	18	26.2	4-2

A1.3 Input 3 Parameters

Applicable only to module variants Z3611, Z3621, Z3651, Z4610, Z4620 and Z4660

Pre-calculated MODBUS Parameter Address				Name	Type	Fieldbus Parameter Idents				Ref. Page
Decimal		Hexadecimal				Class	Instance	Parameter		
Bit	Word	Bit	Word					Bit	Word	
	65		0041	Input Type & Range	R/W	00	2		1	4-2
	66		0042	Units	R/W (T/C & RTD inputs) R/O (DC inputs)	00	2		2	4-2
	67		0043	Scale Range Maximum	R/W	00	2		3	4-3
	68		0044	Scale Range Minimum	R/W	00	2		4	4-3
	69		0045	Process Variable Offset	R/W	00	2		5	4-1
	70		0046	Input Filter Time Constant	R/W	00	2		6	4-1
	88		0058	External Input Value	R/W	00	2		24	4-4
	89		0059	Process Variable	R/O	00	2		25	4-1
80	90	0050	005A	Over-range Flag	R/O	00	2	16	26.0	4-1
81	90	0051	005A	Under-range Flag	R/O	00	2	17	26.1	4-2
82	90	0052	005A	Sensor Break Flag	R/O	00	2	18	26.2	4-2

A1.4 Input 4 Parameters

Applicable only to module variants Z4610, Z4620 and Z4660

Pre-calculated MODBUS Parameter Address				Name	Type	Fieldbus Parameter Idents				Ref. Page
Decimal		Hexadecimal				Class	Instance	Parameter		
Bit	Word	Bit	Word					Bit	Word	
	97		0061	Input Type & Range	R/W	00	3		1	4-2
	98		0062	Units	R/W (T/C & RTD inputs) R/O (DC inputs)	00	3		2	4-2
	99		0063	Scale Range Maximum	R/W	00	3		3	4-3
	100		0064	Scale Range Minimum	R/W	00	3		4	4-3
	101		0065	Process Variable Offset	R/W	00	3		5	4-1
	102		0066	Input Filter Time Constant	R/W	00	3		6	4-1
	120		0078	External Input Value	R/W	00	3		24	4-4
	121		0079	Process Variable	R/O	00	3		25	4-1
112	122	0070	007A	Over-range Flag	R/O	00	3	16	26.0	4-1
113	122	0071	007A	Under-range Flag	R/O	00	3	17	26.1	4-2
114	122	0072	007A	Sensor Break Flag	R/O	00	3	18	26.2	4-2

A2 Output Parameters

A2.1 Output 1 Parameters

Pre-calculated MODBUS Parameter Address				Name	Type	Fieldbus Parameter Idents				Ref. Page
Decimal		Hexadecimal				Class	Instance	Parameter		
Bit	Word	Bit	Word					Bit	Word	
	257		0101	Output Type	R/W	01	0		1	4-4
	258		0102	Loop	R/W	01	0		2	4-6
	259		0103	Output Usage	R/W	01	0		3	4-5
	260		0104	Output Cycle Time	R/W	01	0		4	4-5
	263		0107	Output Alarms for loop 1	R/W	01	0		7	4-4
	264		0108	Output Alarms for loop 2 (Only available for Multiple loop Modules)	R/W	01	0		8	4-4
	265		0109	Output Alarms for loop 3 (Only available for Multiple loop Modules)	R/W	01	0		9	4-4
	266		010A	Output Alarms for loop 4 (Only available for Four loop Modules)	R/W	01	0		10	4-4
	281		0119	Bus Power	R/W	01	0		25	4-6
272	282	0110	011A	Output State	R/O	01	0	16	26.0	4-5

A2.2 Output 2 Parameters

Pre-calculated MODBUS Parameter Address				Name	Type	Fieldbus Parameter Idents				Ref. Page
Decimal		Hexadecimal				Class	Instance	Parameter		
Bit	Word	Bit	Word					Bit	Word	
	289		0121	Output Type	R/W	01	1		1	4-4
	290		0122	Loop	R/W	01	1		2	4-6
	291		0123	Output Usage	R/W	01	1		3	4-5
	292		0124	Output Cycle Time	R/W	01	1		4	4-5
	295		0127	Output Alarms for loop 1	R/W	01	1		7	4-4
	296		0128	Output Alarms for loop 2 (Only available for Multiple loop Modules)	R/W	01	1		8	4-4
	297		0129	Output Alarms for loop 3 (Only available for Multiple loop Modules)	R/W	01	1		9	4-4
	298		012A	Output Alarms for loop 4 (Only available for Four loop Modules)	R/W	01	1		10	4-4
	313		0139	Bus Power	R/W	01	1		25	4-6
304	314	0130	013A	Output State	R/O	01	1	16	26.0	4-5

A2.3 Output 3 Parameters

Applicable only to module variants Z1300, Z1301, Z3621, Z3611, Z3651, Z4610, Z4620 and Z4660

Pre-calculated MODBUS Parameter Address				Name	Type	Fieldbus Parameter Idents				Ref. Page
Decimal		Hexadecimal				Class	Instance	Parameter		
Bit	Word	Bit	Word					Bit	Word	
	321		0141	Output Type	R/W	01	2		1	4-4
	322		0142	Loop	R/W	01	2		2	4-6
	323		0143	Output Usage	R/W	01	2		3	4-5
	324		0144	Output Cycle Time	R/W	01	2		4	4-5
	325		0145	Linear Output Scale Max. (Not applicable to multiple loop Modules)	R/W	01	2		5	4-6
	326		0146	Linear Output Scale Min. (Not applicable to multiple loop Modules)	R/W	01	2		6	4-6
	327		0147	Output Alarms for loop 1	R/W	01	2		7	4-4
	328		0148	Output Alarms for loop 2 (Only available for Multiple loop Modules)	R/W	01	2		8	4-4
	329		0149	Output Alarms for loop 3 (Only available for Multiple loop Modules)	R/W	01	2		9	4-4
	330		014A	Output Alarms for loop 4 (Only available for Four loop Modules)	R/W	01	2		10	4-4
	345		0159	Bus Power	R/W	01	2		25	4-6
336	346	0150	015A	Output State	R/O	01	2	16	26.0	4-5

A2.4 Output 4 Parameters

Applicable only to module variants Z3621, Z3611, Z3651, Z4610, Z4620 and Z4660

Pre-calculated MODBUS Parameter Address				Name	Type	Fieldbus Parameter Idents				Ref. Page
Decimal		Hexadecimal				Class	Instance	Parameter		
Bit	Word	Bit	Word					Bit	Word	
	353		0161	Output Type	R/W	01	3		1	4-4
	354		0162	Loop	R/W	01	3		2	4-6
	355		0163	Output Usage	R/W	01	3		3	4-5
	356		0164	Output Cycle Time	R/W	01	3		4	4-5
	359		0167	Output Alarms for loop 1	R/W	01	3		7	4-4
	360		0168	Output Alarms for loop 2 (Only available for Multiple loop Modules)	R/W	01	3		8	4-4
	361		0169	Output Alarms for loop 3 (Only available for Multiple loop Modules)	R/W	01	3		9	4-4
	362		016A	Output Alarms for loop 4 (Only available for Four loop Modules)	R/W	01	3		10	4-4
	377		0179	Bus Power	R/W	01	3		25	4-6
368	378	0170	017A	Output State	R/O	01	3	16	26.0	4-5

A2.5 Output 5 Parameters

Applicable only to module variants Z3621, Z3611, Z3651, Z4610, Z4620 and Z4660

Pre-calculated MODBUS Parameter Address				Name	Type	Fieldbus Parameter Idents				Ref. Page
Decimal		Hexadecimal				Class	Instance	Parameter		
Bit	Word	Bit	Word					Bit	Word	
	385		0181	Output Type	R/W	01	4		1	4-4
	386		0182	Loop	R/W	01	4		2	4-6
	387		0183	Output Usage	R/W	01	4		3	4-5
	388		0184	Output Cycle Time	R/W	01	4		4	4-5
	391		0187	Output Alarms for loop 1	R/W	01	4		7	4-4
	392		0188	Output Alarms for loop 2 (Only available for Multiple loop Modules)	R/W	01	4		8	4-4
	393		0189	Output Alarms for loop 3 (Only available for Multiple loop Modules)	R/W	01	4		9	4-4
	394		018A	Output Alarms for loop 4 (Only available for Four loop Modules)	R/W	01	4		10	4-4
	409		0199	Bus Power	R/W	01	4		25	4-6
400	410	0190	019A	Output State	R/O	01	4	16	26.0	4-5

A2.6 Output 6 Parameters

Applicable only to module variants Z3621, Z3611, Z3651, Z4610, Z4620 and Z4660

Pre-calculated MODBUS Parameter Address				Name	Type	Fieldbus Parameter Idents				Ref. Page
Decimal		Hexadecimal				Class	Instance	Parameter		
Bit	Word	Bit	Word					Bit	Word	
	417		01A1	Output Type	R/W	01	5		1	4-4
	418		01A2	Loop	R/W	01	5		2	4-6
	419		01A3	Output Usage	R/W	01	5		3	4-5
	420		01A4	Output Cycle Time	R/W	01	5		4	4-5
	423		01A7	Output Alarms for loop 1	R/W	01	5		7	4-4
	424		01A8	Output Alarms for loop 2 (Only available for Multiple loop Modules)	R/W	01	5		8	4-4
	425		01A9	Output Alarms for loop 3 (Only available for Multiple loop Modules)	R/W	01	5		9	4-4
	426		01AA	Output Alarms for loop 4 (Only available for Four loop Modules)	R/W	01	5		10	4-4
	441		01B9	Bus Power	R/W	01	5		25	4-6
432	442	01B0	01BA	Output State	R/O	01	5	16	26.0	4-5

A3 Setpoint Parameters

A3.1 Loop 1 Setpoint Parameters

Pre-calculated MODBUS Parameter Address				Name	Type	Fieldbus Parameter Idents			Ref. Page	
Decimal		Hexadecimal				Class	Instance	Parameter		
Bit	Word	Bit	Word					Bit		Word
	513		0201	Setpoint Ramp Rate	R/W	02	0	1	4-8	
	514		0202	Setpoint Select	R/W	02	0	2	4-7	
	515		0203	Setpoint 1	R/W	02	0	3	4-7	
	516		0204	Setpoint 2	R/W	02	0	4	4-7	
	537		0219	Actual Setpoint	R/O	02	0	25	4-7	

A3.2 Loop 2 Setpoint Parameters

Applicable only to module variants Z3621, Z3611, Z3651, Z4610, Z4620 and Z4660

Pre-calculated MODBUS Parameter Address				Name	Type	Fieldbus Parameter Idents			Ref. Page	
Decimal		Hexadecimal				Class	Instance	Parameter		
Bit	Word	Bit	Word					Bit		Word
	545		0221	Setpoint Ramp Rate	R/W	02	1	1	4-8	
	546		0222	Setpoint Select	R/W	02	1	2	4-7	
	547		0223	Setpoint 1	R/W	02	1	3	4-7	
	548		0224	Setpoint 2	R/W	02	1	4	4-7	
	569		0239	Actual Setpoint	R/O	02	1	25	4-7	

A3.3 Loop 3 Setpoint Parameters

Applicable only to module variants Z3621, Z3611, Z3651, Z4610, Z4620 and Z4660

Pre-calculated MODBUS Parameter Address				Name	Type	Fieldbus Parameter Idents			Ref. Page	
Decimal		Hexadecimal				Class	Instance	Parameter		
Bit	Word	Bit	Word					Bit		Word
	577		0241	Setpoint Ramp Rate	R/W	02	2	1	4-8	
	578		0242	Setpoint Select	R/W	02	2	2	4-7	
	579		0243	Setpoint 1	R/W	02	2	3	4-7	
	580		0244	Setpoint 2	R/W	02	2	4	4-7	
	601		0259	Actual Setpoint	R/O	02	2	25	4-7	

A3.4 Loop 4 Setpoint Parameters

Applicable only to module variants Z4620, Z4610 and Z4660

Pre-calculated MODBUS Parameter Address				Name	Type	Fieldbus Parameter Idents			Ref. Page	
Decimal		Hexadecimal				Class	Instance	Parameter		
Bit	Word	Bit	Word					Bit		Word
	609		0261	Setpoint Ramp Rate	R/W	02	3	1	4-8	
	610		0262	Setpoint Select	R/W	02	3	2	4-7	
	611		0263	Setpoint 1	R/W	02	3	3	4-7	
	612		0264	Setpoint 2	R/W	02	3	4	4-7	
	633		0279	Actual Setpoint	R/O	02	3	25	4-7	

A4 Control Parameters

A4.1 Loop 1 Control Parameters

Pre-calculated MODBUS Parameter Address				Name	Type	Fieldbus Parameter Idents				Ref. Page
Decimal		Hexadecimal				Class	Instance	Parameter		
Bit	Word	Bit	Word					Bit	Word	
768	768	0300	0300	Manual Control Enable/Disable	R/W	03	0	0	0.0	4-9
769	768	0301	0300	Programmable Sensor Break	R/W	03	0	1	0.1	4-19
770	768	0302	0300	Select Continuous Self Tune	R/W	03	0	2	0.2	4-10
771	768	0303	0300	Select Auto Easy Tune	R/W	03	0	3	0.3	4-12
772	768	0304	0300	Control Output Action	R/W	03	0	4	0.4	4-19
773	768	0305	0300	Control Type	R/W	03	0	5	0.5	4-16
774	768	0306	0300	Loop Alarm Enable	R/W	03	0	6	0.6	4-15
775	768	0307	0300	Auto Pre-Tune	R/W	03	0	7	0.7	4-13
776	768	0308	0300	Reserved	N/A	03	0	8	0.8	----
777	768	0309	0300	Loop Enable/Disable	R/W	03	0	9	0.9	4-9
	769		0301	Primary Output Power Limit	R/W	03	0		1	4-13
	770		0302	Proportional Band 1	R/W	03	0		2	4-16
	771		0303	Proportional Band 2	R/W	03	0		3	4-17
	772		0304	Reset/Loop Alarm Time	R/W	03	0		4	4-17
	773		0305	Rate	R/W	03	0		5	4-17
	774		0306	Overlap/Deadband	R/W	03	0		6	4-18
	775		0307	Bias (manual Reset)	R/W	03	0		7	4-19
	776		0308	ON/OFF Differential	R/W	03	0		8	4-19
	777		0309	Manual Power	R/W	03	0		9	4-9
	778		030A	Preset Power Output	R/W	03	0		10	4-20
	779		030B	Soft Start Setpoint	R/W	03	0		11	4-15
	780		030C	Soft Start Time	R/W	03	0		12	4-15
	781		030D	Soft Start Primary Output Power Limit	R/W	03	0		13	4-15
	792		0318	Primary Output Power	R/O	03	0		24	4-15
	793		0319	Secondary Output Power	R/O	03	0		25	4-15
784	794	0310	031A	Loop Alarm Status	R/O*	03	0	16	26.0	4-16
785	794	0311	031A	Easy Tune	R/W	03	0	17	26.1	4-10
786	794	0312	031A	Pre-Tune	R/W	03	0	18	26.2	4-12

* Write operations to these parameters are accepted but ignored

A4.2 Loop 2 Control Parameters

Applicable only to module variants Z3611, Z3621, Z3651, Z4610, Z4620 and Z4660

Pre-calculated MODBUS Parameter Address				Name	Type	Fieldbus Parameter Idents				Ref. Page
Decimal		Hexadecimal				Class	Instance	Parameter		
Bit	Word	Bit	Word					Bit	Word	
800	800	0320	0320	Manual Control Enable/Disable	R/W	03	1	0	0.0	4-9
801	800	0321	0320	Programmable Sensor Break	R/W	03	1	1	0.1	4-19
802	800	0322	0320	Select Continuous Self Tune	R/W	03	1	2	0.2	4-10
803	800	0323	0320	Select Auto Easy Tune	R/W	03	1	3	0.3	4-12
804	800	0324	0320	Control Output Action	R/W	03	1	4	0.4	4-19
805	800	0325	0320	Control Type	R/W	03	1	5	0.5	4-16
806	800	0326	0320	Loop Alarm Enable	R/W	03	1	6	0.6	4-15
807	800	0327	0320	Auto Pre-Tune	R/W	03	1	7	0.7	4-13
808	800	0328	0320	Reserved	N/A	03	1	8	0.8	----
809	800	0329	0320	Loop Enable/Disable	R/W	03	1	9	0.9	4-9
	801		0321	Primary Output Power Limit	R/W	03	1		1	4-13
	802		0322	Proportional Band 1	R/W	03	1		2	4-16
	803		0323	Proportional Band 2	R/W	03	1		3	4-17
	804		0324	Reset/Loop Alarm Time	R/W	03	1		4	4-17
	805		0325	Rate	R/W	03	1		5	4-17
	806		0326	Overlap/Deadband	R/W	03	1		6	4-18
	807		0327	Bias (manual Reset)	R/W	03	1		7	4-19
	808		0328	ON/OFF Differential	R/W	03	1		8	4-19
	809		0329	Manual Power	R/W	03	1		9	4-9
	810		032A	Preset Power Output	R/W	03	1		10	4-20
	811		032B	Soft Start Setpoint	R/W	03	1		11	4-15
	812		032C	Soft Start Time	R/W	03	1		12	4-15
	813		032D	Soft Start Primary Output Power Limit	R/W	03	1		13	4-15
	824		0338	Primary Output Power	R/O	03	1		24	4-15
	825		0339	Secondary Output Power	R/O	03	1		25	4-15
816	826	0330	033A	Loop Alarm Status	R/O *	03	1	16	26.0	4-16
817	826	0331	033A	Easy Tune	R/W	03	1	17	26.1	4-10
818	826	0332	033A	Pre-Tune	R/W	03	1	18	26.2	4-12

* Write operations to these parameters are accepted but ignored

A4.3 Loop 3 Control Parameters

Applicable only to module variants Z3611, Z3621, Z3651, Z4610, Z4620 and Z4660

Pre-calculated MODBUS Parameter Address				Name	Type	Fieldbus Parameter Idents				Ref. Page
Decimal		Hexadecimal				Class	Instance	Parameter		
Bit	Word	Bit	Word					Bit	Word	
832	832	0340	0340	Manual Control Enable/Disable	R/W	03	2	0	0.0	4-9
833	832	0341	0340	Programmable Sensor Break	R/W	03	2	1	0.1	4-19
834	832	0342	0340	Continuous Self Tune	R/W	03	2	2	0.2	4-10
835	832	0343	0340	Auto Easy Tune	R/W	03	2	3	0.3	4-12
836	832	0344	0340	Control Output Action	R/W	03	2	4	0.4	4-19
837	832	0345	0340	Control Type	R/W	03	2	5	0.5	4-16
838	832	0346	0340	Loop Alarm Enable	R/W	03	2	6	0.6	4-15
839	832	0347	0340	Auto Pre-Tune	R/W	03	2	7	0.7	4-13
840	832	0348	0340	Reserved	N/A	03	2	8	0.8	----
841	832	0349	0340	Loop Enable/Disable	R/W	03	2	9	0.9	4-9
	833		0341	Primary Output Power Limit	R/W	03	2		1	4-13
	834		0342	Proportional Band 1	R/W	03	2		2	4-16
	835		0343	Proportional Band 2	R/W	03	2		3	4-17
	836		0344	Reset/Loop Alarm Time	R/W	03	2		4	4-17
	837		0345	Rate	R/W	03	2		5	4-17
	838		0346	Overlap/Deadband	R/W	03	2		6	4-18
	839		0347	Bias (manual Reset)	R/W	03	2		7	4-19
	840		0348	ON/OFF Differential	R/W	03	2		8	4-19
	841		0349	Manual Power	R/W	03	2		9	4-9
	842		034A	Preset Power Output	R/W	03	2		10	4-20
	843		034B	Soft Start Setpoint	R/W	03	2		11	4-15
	844		034C	Soft Start Time	R/W	03	2		12	4-15
	845		034D	Soft Start Primary Output Power Limit	R/W	03	2		13	4-15
	856		0358	Primary Output Power	R/O	03	2		24	4-15
	857		0359	Secondary Output Power	R/O	03	2		25	4-15
848	858	0350	035A	Loop Alarm Status	R/O *	03	2	16	26.0	4-16
849	858	0351	035A	Easy Tune	R/W	03	2	17	26.1	4-10
850	858	0352	035A	Pre-Tune	R/W	03	2	18	26.2	4-12

* Write operations to these parameters are accepted but ignored

A4.4 Loop 4 Control Parameters

Applicable only to module variants Z4610, Z4620 and Z4660

Pre-calculated MODBUS Parameter Address				Name	Type	Fieldbus Parameter Idents				Ref. Page
Decimal		Hexadecimal				Class	Instance	Parameter		
Bit	Word	Bit	Word					Bit	Word	
864	864	0360	0360	Manual Control Enable/Disable	R/W	03	3	0	0.0	4-9
865	864	0361	0360	Programmable Sensor Break	R/W	03	3	1	0.1	4-19
866	864	0362	0360	Continuous Self Tune	R/W	03	3	2	0.2	4-10
867	864	0363	0360	Auto Easy Tune	R/W	03	3	3	0.3	4-12
868	864	0364	0360	Control Output Action	R/W	03	3	4	0.4	4-19
869	864	0365	0360	Control Type	R/W	03	3	5	0.5	4-16
870	864	0366	0360	Loop Alarm Enable	R/W	03	3	6	0.6	4-15
871	864	0367	0360	Auto Pre-Tune	R/W	03	3	7	0.7	4-13
872	864	0368	0360	Reserved	N/A	03	3	8	0.8	----
873	864	0369	0360	Loop Enable/Disable	R/W	03	3	9	0.9	4-9
	865		0361	Primary Output Power Limit	R/W	03	3		1	4-13
	866		0362	Proportional Band 1	R/W	03	3		2	4-16
	867		0363	Proportional Band 2	R/W	03	3		3	4-17
	868		0364	Reset/Loop Alarm Time	R/W	03	3		4	4-17
	869		0365	Rate	R/W	03	3		5	4-17
	870		0366	Overlap/Deadband	R/W	03	3		6	4-18
	871		0367	Bias (manual Reset)	R/W	03	3		7	4-19
	872		0368	ON/OFF Differential	R/W	03	3		8	4-19
	873		0369	Manual Power	R/W	03	3		9	4-9
	874		036A	Preset Power Output	R/W	03	3		10	4-20
	875		036B	Soft Start Setpoint	R/W	03	3		11	4-15
	876		036C	Soft Start Time	R/W	03	3		12	4-15
	877		036D	Soft Start Primary Output Power Limit	R/W	03	3		13	4-15
	888		0378	Primary Output Power	R/O	03	3		24	4-15
	889		0379	Secondary Output Power	R/O	03	3		25	4-15
880	890	0370	037A	Loop Alarm	R/O *	03	3	16	26.0	4-16
881	890	0371	037A	Easy Tune	R/W	03	3	17	26.1	4-10
882	890	0372	037A	Pre-Tune	R/W	03	3	18	26.2	4-12

* Write operations to these parameters are accepted but ignored

A5 Alarm Parameters

A5.1 Loop 1, Alarm 1 Parameters

Pre-calculated MODBUS Parameter Address				Name	Type	Fieldbus Parameter Idents				Ref. Page
Decimal		Hexadecimal				Class	Instance	Parameter		
Bit	Word	Bit	Word					Bit	Word	
1024	1024	0400	0400	Alarm Inhibit	R/W	04	0	0	0.0	4-23
	1025		0401	Alarm Type	R/W	04	0		1	4-21
	1026		0402	Alarm Value	R/W	04	0		2	4-23
	1027		0403	Alarm Hysteresis	R/W	04	0		3	4-22
1040	1050	0410	041A	Alarm State	R/O	04	0	16	26.0	4-23

A5.2 Loop 1, Alarm 2 Parameters

Pre-calculated MODBUS Parameter Address				Name	Type	Fieldbus Parameter Idents				Ref. Page
Decimal		Hexadecimal				Class	Instance	Parameter		
Bit	Word	Bit	Word					Bit	Word	
1056	1056	0420	0420	Alarm Inhibit	R/W	04	1	0	0.0	4-23
	1057		0421	Alarm Type	R/W	04	1		1	4-21
	1058		0422	Alarm Value	R/W	04	1		2	4-23
	1059		0423	Alarm Hysteresis	R/W	04	1		3	4-22
1072	1082	0430	043A	Alarm State	R/O	04	1	16	26.0	4-23

A5.3 Loop 2, Alarm 1 Parameters

Applicable only to module variants Z3611, Z3621, Z3651, Z4610, Z4620 and Z4660

Pre-calculated MODBUS Parameter Address				Name	Type	Fieldbus Parameter Idents				Ref. Page
Decimal		Hexadecimal				Class	Instance	Parameter		
Bit	Word	Bit	Word					Bit	Word	
1088	1088	0440	0440	Alarm Inhibit	R/W	04	2	0	0.0	4-23
	1089		0441	Alarm Type	R/W	04	2		1	4-21
	1090		0442	Alarm Value	R/W	04	2		2	4-23
	1091		0443	Alarm Hysteresis	R/W	04	2		3	4-22
1104	1114	0450	045A	Alarm State	R/O	04	2	16	26.0	4-23

A5.4 Loop 2, Alarm 2 Parameters

Applicable only to module variants Z3611, Z3621, Z3651, Z4610, Z4620 and Z4660

Pre-calculated MODBUS Parameter Address				Name	Type	Fieldbus Parameter Idents				Ref. Page
Decimal		Hexadecimal				Class	Instance	Parameter		
Bit	Word	Bit	Word					Bit	Word	
1120	1120	0460	0460	Alarm Inhibit	R/W	04	3	0	0.0	4-23
	1121		0461	Alarm Type	R/W	04	3		1	4-21
	1122		0462	Alarm Value	R/W	04	3		2	4-23
	1123		0463	Alarm Hysteresis	R/W	04	3		3	4-22
1136	1146	0470	047A	Alarm State	R/O	04	3	16	26.0	4-23

A5.5 Loop 3, Alarm 1 Parameters

Applicable only to module variants Z3611, Z3621, Z3651, Z4610, Z4620 and Z4660

Pre-calculated MODBUS Parameter Address				Name	Type	Fieldbus Parameter Idents				Ref. Page
Decimal		Hexadecimal				Class	Instance	Parameter		
Bit	Word	Bit	Word					Bit	Word	
1152	1152	0480	0480	Alarm Inhibit	R/W	04	4	0	0.0	4-23
	1153		0481	Alarm Type	R/W	04	4		1	4-21
	1154		0482	Alarm Value	R/W	04	4		2	4-23
	1155		0483	Alarm Hysteresis	R/W	04	4		3	4-22
1168	1178	0490	049A	Alarm State	R/O	04	4	16	26.0	4-23

A5.6 Loop 3, Alarm 2 Parameters

Applicable only to module variants Z3611, Z3621, Z3651, Z4610, Z4620 and Z4660

Pre-calculated MODBUS Parameter Address				Name	Type	Fieldbus Parameter Idents				Ref. Page
Decimal		Hexadecimal				Class	Instance	Parameter		
Bit	Word	Bit	Word					Bit	Word	
1184	1184	04A0	04A0	Alarm Inhibit	R/W	04	5	0	0.0	4-23
	1185		04A1	Alarm Type	R/W	04	5		1	4-21
	1186		04A2	Alarm Value	R/W	04	5		2	4-23
	1187		04A3	Alarm Hysteresis	R/W	04	5		3	4-22
1200	1210	04B0	04BA	Alarm State	R/O	04	5	16	26.0	4-23

A5.7 Loop 4, Alarm 1 Parameters

Applicable only to module variants Z4610, Z4620 and Z4660

Pre-calculated MODBUS Parameter Address				Name	Type	Fieldbus Parameter Idents				Ref. Page
Decimal		Hexadecimal				Class	Instance	Parameter		
Bit	Word	Bit	Word					Bit	Word	
1216	1216	04C0	04C0	Alarm Inhibit	R/W	04	6	0	0.0	4-23
	1217		04C1	Alarm Type	R/W	04	6		1	4-21
	1218		04C2	Alarm Value	R/W	04	6		2	4-23
	1219		04C3	Alarm Hysteresis	R/W	04	6		3	4-22
1232	1242	04D0	04DA	Alarm State	R/O	04	6	16	26.0	4-23

A5.8 Loop 4, Alarm 2 Parameters

Applicable only to module variants Z4610, Z4620 and Z4660

Pre-calculated MODBUS Parameter Address				Name	Type	Fieldbus Parameter Idents				Ref. Page
Decimal		Hexadecimal				Class	Instance	Parameter		
Bit	Word	Bit	Word					Bit	Word	
1248	1248	04E0	04E0	Alarm Inhibit	R/W	04	7	0	0.0	4-23
	1249		04E1	Alarm Type	R/W	04	7		1	4-21
	1250		04E2	Alarm Value	R/W	04	7		2	4-23
	1251		04E3	Alarm Hysteresis	R/W	04	7		3	4-22
1264	1274	04F0	04FA	Alarm State	R/O	04	7	16	26.0	4-23

A6 Heater Current Parameters

A6.1 Loop 1 Heater Current Parameters

Applicable only to module variants Z1301, Z3611, Z3621 and Z3651

Pre-calculated MODBUS Parameter Address				Name	Type	Fieldbus Parameter Idents				Ref. Page
Decimal		Hexadecimal				Class	Instance	Parameter		
Bit	Word	Bit	Word					Bit	Word	
1536	1536	0600	0600	Short Circuit Heater Break Alarm Enable/Disable	R/W	06	0	0	0.0	4-26
	1537		0601	Heater Current Input Range *	R/W	06	0		1	4-24
	1538		0602	Heater Current Scale Range Maximum *	R/W	06	0		2	4-24
	1539		0603	Low Heater Break Alarm value	R/W	06	0		3	4-25
	1540		0604	High Heater Break Alarm value	R/W	06	0		4	4-25
	1541		0605	Heater Current Period *	R/W	06	0		5	4-27
	1559		0617	Live Heater Current Value **	R/O	06	0		23	
	1560		0618	Bus Input Value *	R/W	06	0		24	4-27
	1561		0619	Heater Current Value	R/O	06	0		25	4-24
1552	1562	0610	061A	Low Heater Break Alarm state	R/O	06	0	16	26.0	4-26
1553	1562	0611	061A	High Heater Break Alarm state	R/O	06	0	17	26.1	4-26
1554	1562	0612	061A	Short Circuit Heater Break Alarm state	R/O	06	0	18	26.2	4-26

A6.2 Loop 2 Heater Current Parameters

Applicable only to module variants Z3611, Z3621 and Z3651

Pre-calculated MODBUS Parameter Address				Name	Type	Fieldbus Parameter Idents				Ref. Page
Decimal		Hexadecimal				Class	Instance	Parameter		
Bit	Word	Bit	Word					Bit	Word	
1552	1552	0600	0610	Short Circuit Heater Break Alarm Enable/Disable	R/W	06	1	0	0.0	4-26
	1553		0611	Heater Current Input Range *	R/W	06	1		1	4-24
	1554		0612	Heater Current Scale Range Maximum *	R/W	06	1		2	4-24
	1555		0613	Low Heater Break Alarm value	R/W	06	1		3	4-25
	1556		0614	High Heater Break Alarm value	R/W	06	1		4	4-25
	1557		0615	Heater Current Period *	R/W	06	1		5	4-27
	1591		0637	Live Heater Current Value **	R/O	06	1		23	
	1592		0638	Bus Input Value *	R/W	06	1		24	4-27
	1593		0639	Heater Current Value	R/O	06	1		25	4-24
1584	1594	0630	063A	Low Heater Break Alarm state	R/O	06	1	16	26.0	4-26
1585	1594	0631	063A	High Heater Break Alarm state	R/O	06	1	17	26.1	4-26
1586	1594	0632	063A	Short Circuit Heater Break Alarm state	R/O	06	1	18	26.2	4-26

* Any change to these parameters is copied across all instances.

** These parameters have the same value across all instances.

A6.3 Loop 3 Heater Current Parameters

Applicable only to module variants Z3611, Z3621 and Z3651

Pre-calculated MODBUS Parameter Address				Name	Type	Fieldbus Parameter Idents				Ref. Page
Decimal		Hexadecimal				Class	Instance	Parameter		
Bit	Word	Bit	Word					Bit	Word	
1568	1568	0620	0620	Short Circuit Heater Break Alarm Enable/Disable	RW	06	2	0	0.0	4-26
	1569		0621	Heater Current Input Range *	R/W	06	2		1	4-24
	1570		0622	Heater Current Scale Range Maximum *	R/W	06	2		2	4-24
	1571		0623	Low Heater Break Alarm value	R/W	06	2		3	4-25
	1572		0624	High Heater Break Alarm value	R/W	06	2		4	4-25
	1573		0625	Heater Current Period *	R/W	06	2		5	4-27
	1623		0657	Live Heater Current Value **	R/O	06	2		23	
	1624		0658	Bus Input Value *	R/W	06	2		24	4-27
	1625		0659	Heater Current Value	R/O	06	2		25	4-24
1616	1626	0650	065A	Low Heater Break Alarm state	R/O	06	2	16	26.0	4-26
1617	1626	0651	065A	High Heater Break Alarm state	R/O	06	2	17	26.1	4-26
1618	1626	0652	065A	Short Circuit Heater Break Alarm state	R/O	06	2	18	26.2	4-26

* Any change to these parameters is copied across all instances.

** These parameters have the same value across all instances.

A7 Loop Module Descriptor Parameters

Pre-calculated MODBUS Parameter Address				Name	Type	Fieldbus Parameter Idents				Ref. Page
Decimal		Hexadecimal				Class	Instance	Parameter		
Bit	Word	Bit	Word					Bit	Word	
	3841		0F01	Loop Module Serial Number	R/O	15	0		1	4-28
	3842		0F02						2	
	3843		0F03						3	
	3844		0F04						4	
	3845		0F05	Date of Manufacture	R/O	15	0		5	4-28
	3846		0F06						6	
	3847		0F07	Product (Module Type) Identifier	R/O	15	0		7	4-28
	3848		0F08	Firmware ID	R/O	15	0		8	4-28
	3865		0F19	Status Indicators	R/O	15	0		25	4-29

A8 Bus Module Descriptor Parameters

Pre-calculated MODBUS Parameter Address				Name	Type	Fieldbus Parameter Idents				Ref. Page
Decimal		Hexadecimal				Class	Instance	Parameter		
Bit	Word	Bit	Word					Bit	Word	
	3841		0F01	Bus Module Serial Number	R/O	15	0		1	4-29
	3842		0F02						2	
	3843		0F03						3	
	3844		0F04						4	
	3845		0F05	Date of Manufacture	R/O	15	0		5	4-29
	3846		0F06						6	
	3847		0F07	Product (Module Type) Identifier	R/O	15	0		7	4-30
	3848		0F08	Firmware ID	R/O	15	0		8	4-30
	3849		0F09	Database ID	R/O	15	0		9	4-30

APPENDIX B TECHNICAL SPECIFICATIONS

B1 Bus Module

GENERAL	
MODBUS Port: (BM220-MB)	This is an optional RS485 port for connection to a MODBUS master device. Data rate and format are configurable via the RS232 port. MODBUS RTU protocol is supported, using an RS485 physical layer. The load is no greater than one-quarter unit load. The data rate is selectable from 4800, 9600 or 19200 Baud. It is factory-set to 9600 Baud. Parity is selectable from none, even or odd. The base address can be set in the range 1 - 247 (default = 96) Node addressing, data rate and character format are selectable via the MLC 9000+ Workshop Software running on the PC connected to the RS232 Port.
DeviceNet Port: (BM230-DN)	This is a port for connection to a DeviceNet master device. Data rate and MAC ID are configurable via the configuration port. The data rate is selectable from (in kbps) 125, 250 or 500. It is factory-set to 125kbps. The MAC ID can be set in the range 0 - 63 (default = 63).
PROFIBUS Port: (BM240-PB)	This port is for connection to a PROFIBUS DP network. The PROFIBUS data rate is automatically detected and set by the Bus Module. The PROFIBUS interface can communicate at the following data rates; 9.6kbps, 19.2kbps, 45.45kbps, 93.75kbps, 187.5kbps, 500kbps, 1.5Mbps, 3Mbps, 6Mbps, 12Mbps. PROFIBUS address and byte order are configurable via the RS232 port. The PROFIBUS address can be set in the range 0 to 126 (126=default).
Ethernet/IP Port: (BM250-EI)	This port is for connection to an Ethernet/IP network. 10/100BaseT, user definable IP address, MAC ID 0 – 63 (Default ID 63) Configured using the MLC9000+ Workshop software, via the configuration port
MODBUS/TCP Port: (BM250-MT)	This port is for connection to an MODBUS/TCP network 10/100BaseT, user definable IP address Configured using the MLC9000+ Workshop software, via the configuration port
Supply Voltage	18 to 30V DC (including ripple) 30W maximum
ENVIRONMENTAL	
Operating Conditions	Ambient Temperature: 0°C to 55°C Relative Humidity: 30% to 90% non-condensing
Storage Conditions	Ambient Temperature: -20°C to 80°C Relative Humidity: 30% to 90% non-condensing
APPROVALS MODBUS	
EMC standard	EN61326-1.
Safety	Complies with EN61010-1 and UL 3121-1.
Certification	Awaiting Certification from the MODBUS organization
APPROVALS DeviceNet	
EMC standard	EN61326-1.
Safety	Complies with EN61010-1 and UL 3121-1.
Certification	Awaiting Certification from the ODVA
APPROVALS PROFIBUS	
EMC standard	EMC EN61326:1998.
Safety	Complies with EN61010-1:1995 and UL 3121-1:1998.
Certification	Certification from PROFIBUS Organisation (See www.westinstruments.com or Section 7 for details)

APPROVALS Ethernet/IP	
EMC standard	EMC EN61326:1998.
Safety	Complies with EN61010-1:1995 and UL 3121-1:1998.
Certification	Awaiting Certification from ODVA

APPROVALS MODBUS TCP/IP	
EMC standard	EMC EN61326:1998.
Safety	Complies with EN61010-1:1995 and UL 3121-1:1998.
Certification	Awaiting Certification from the MODBUS organisation

PHYSICAL	
Dimensions	Height - 100mm; Width - 30mm; Depth - 120mm
Mounting	Directly mounted on 35mm x 7.5mm Top Hat DIN rail (EN50022, DIN46277-3)
Connectors	Power input: 2-way 5.08mm Combicon type RS232 port: 6-way RJII Type BM220 port: 3-way 5.08mm Combicon type BM230 port: 5-way 5.08mm Combicon type BM240 port: 9-way D-type BM250 port: RJ45 Type
Weight	0.21kg

B2 Loop Modules

GENERAL	
Function	Each Loop Module performs the control functions and provides the input and output connections for its own control loops. Up to 4 universal process inputs and up to 6 outputs. (dependent on model variant)
Types Available	Z1200: One Universal input, two SSR/relay outputs (selectable) Z1300: One Universal input, two SSR/relay outputs and one Linear output or three SSR/relay outputs (selectable) Z1301: One Universal input, one Heater Break input, two SSR/relay outputs and one Linear or three SSR/relay outputs (selectable) Z3611: Three Universal inputs, one Heater Break input, six relay outputs Z3621: Three Universal inputs, one Heater Break input, six SSR outputs Z3651: Three Universal inputs, one Heater Break input, three SSR outputs and three relay outputs Z4610: Four Universal inputs, six relay outputs Z4620: Four Universal inputs, six SSR outputs Z4660: Four Universal inputs, four SSR outputs and 2 relay outputs
Process input	Type and scale user selectable (see Process inputs table) Sample rate = 10 per second (100ms)
Heater Current Input	Measures a Heater current value via an external CT for use by the Heater Break Alarm function.

PROCESS INPUTS			
Types available (Range Minimum – Range Maximum)			
Thermocouple		RTD	DC Linear
B (100 – 1824°C)	N (0.0 – 1399.6°C)	PT100 (-199.9 – 800.3°C)	0 – 20mA
B (212 – 3315°F)	N (32.0 – 2551.3°F)	PT100 (-327.3 – 1472.5°F)	4 – 20mA
J (-200.1 – 1200.3°C)	R (0 – 1759°C)	NI 120 (-80.0 – 240.0°C)	0 – 50mV
J (-328.2 – 2192.5°F)	R (32 – 3198°F)	NI 120 (-112.0 – 464.0°F)	10 – 50mV
K (-240.1 – 1372.9°C)	S (0 – 1759°C)		0 – 5V
K (-400.2 – 2503.2°F)	S (32 – 3198°F)		1 – 5V
L (-0.1 – 761.4°C)	T (-240.0 – 400.5°C)		0 – 10V
L (31.8 – 1402.5°F)	T (-400.0 – 752.9°F)		2 – 10V
E (-250 - 999°C)			
E (-418 – 1830 °F)			

THERMOCOUPLE INPUTS	
Measurement Accuracy	Better than ±0.2% of range span ±1 LSD. Note: Reduced performance with Type “B” thermocouple between 100 – 600°C (212 – 1112°F). Type “T” accuracy is ±0.5% below -100°C

Linearisation Accuracy	Better than $\pm 0.2^{\circ}\text{C}$ any point, for 0.1°C resolution ranges (0.05°C typical) Better than $\pm 0.5^{\circ}\text{C}$ any point, for 1°C resolution ranges.
CJC	Better than $\pm 1\text{C}$ over operating temperature range.
Sensor Resistance Influence	<10 Ω : as measured accuracy 100 Ω : <0.1% of range span error 1000 Ω : <0.5% of range span error
Thermocouple Calibration	Complies with BS4937, NBS125 & IEC584

RTD INPUTS	
Measurement Accuracy	$\pm 0.2\%$ of range span ± 1 LSD for multiple Loop Modules
Linearisation Accuracy	Better than $\pm 0.2^{\circ}\text{C}$ any point (0.05°C typical)
Temperature Stability	0.01% of range span/ $^{\circ}\text{C}$ change in ambient temperature.
Lead Compensation	Automatic to 50 Ω maximum lead resistance, giving less than 0.5% of span additional error.
RTD Sensor Current	150 μA \pm 10 μA
PT100 Calibration	Complies with BS1904 & DIN43760 ($0.00385\Omega/\Omega/^{\circ}\text{C}$)

DC LINEAR INPUTS	
Measurement Accuracy	Better than $\pm 0.2\%$ of programmed range span ± 1 LSD.
Temperature Stability	0.01% of range span/ $^{\circ}\text{C}$ change in ambient temperature
Input Resistance	mV Input: >1M V Input: 47k mA Input: 4.7
Maximum Resolution	-32000 to 32000. Equivalent to a 16-bit ADC

HEATER CURRENT INPUT (Z1301, Z3611, Z3621 and Z3651 only)	
Accuracy	Better than $\pm 2\%$ of span
Isolation	Via external current transformer
Internal Burden	15
Input Span	0 – 60mA rms. (assuming sinusoidal input current waveform)
Range Maximum	Adjustable 0.1A to 1000.0A
Range Minimum	Fixed at 0A

RELAY OUTPUTS	
Contact Type	Single pole single throw (SPST) Normally open contacts (N/O)
Rating	2A resistive @ 120/240VAC
Lifetime	>500,000 operations at rated voltage/current

SSR DRIVE OUTPUTS	
Drive Capability	12V DC nominal (10V DC minimum) at up to 20mA load
Isolation	Isolated from process input and relay outputs. Not isolated from each other or linear outputs. Not isolated from other similar outputs in the same system.

LINEAR OUTPUT	
Resolution	Eight bits in 250ms (10 bits in 1 second typical)
Accuracy	$\pm 0.25\%$ (mA into 250 Ω load, V into 2k Ω load) Degrading linearly to $\pm 0.5\%$ for increasing burden to maximum drive capability.
Update Rate	10 samples per second
Drive Capability	0-20mA: 500 Ω maximum load 4-20mA: 500 Ω maximum load 0-5V: 500 Ω minimum load 0-10V: 500 Ω minimum load
Isolation	Isolated from process input and relay outputs. Not isolated from SSR Drive outputs or other similar outputs in the same system

OPERATING CONDITIONS	
Ambient Temperature	0°C to 55°C (operating); -20°C to 80°C (storage)
Relative Humidity	30% - 90% non-condensing (operating and storage)
Supply Voltage	Powered by Bus Module within its operating conditions

APPROVALS	
EMC Standard	EN61326-1.
Safety	Complies with EN61010-1 and UL 3121-1.

PHYSICAL	
Dimensions	Height: - 100mm; Width: - 22mm; Depth: - 120mm
Mounting	35mm x 7.5mm Top Hat DIN rail mounting via Interconnect Module (EN50022, DIN46277-3)
Connector Types	All 5.08mm Combicon type
Weight	0.15kg

B3 MLC 9000+ Workshop System Requirements

Software System Requirements	
Microprocessor	133MHz minimum (400MHz recommended)
RAM	64Mb minimum (128Mb recommended)
Hard disk space	64Mb
Display	SVGA Compatible, 800 x 600 or better
Operating System	Windows 2000 SP4/XP SP1a or better
Port Requirements	9-pin (PC-AT) serial port or USB port with external RS232 converter

APPENDIX C PRODUCT CODING

Model Code	MLC 900	-	X	-	X	-	X	-	X
Branding									
	WEST Brand		0						
	Partlow Brand		2						
Bus Module Options									
	MODBUS RTU				BM220		MB		
	DeviceNet				BM230		DN		
	PROFIBUS-DP				BM240		PB		
	Ethernet/IP				BM250		EI		
	MODBUS/TCP				BM250		MT		
Loop Module Options									
	One Universal input, two SSR/Relay outputs				Z1200				
	One Universal input, two SSR/relay outputs and one linear output or three SSR/relay outputs				Z1300				
	One Universal input, One Heater Break input, two SSR/Relay outputs and on Linear output or three SSR/Relay outputs				Z1301				
	Three Universal inputs, one Heater Break input, six SSR outputs				Z3621				
	Three Universal inputs, one Heater Break input, six Relay outputs				Z3611				
	Three Universal inputs, one Heater Break input, three SSR outputs and three Relay outputs				Z3651				
	Four Universal inputs, six SSR outputs				Z4620				
	Four Universal inputs, six Relay outputs				Z4610				
	Four Universal inputs, four SSR outputs and 2 Relay outputs				Z4660				
Ancillaries									
	Configuration Software with cable and MLC 9000+ User Guide				AN111				
	Configuration Software Cable only				AN010				
	MLC 9000+ User Guide only				AN001				
Language Codes									
	English								P1
	French								P2
	German								P3
	Italian								P4
	Spanish								P5
	Chinese (Mandarin)								P6
	All (En/Fr/Ge/It/Sp)								P9

APPENDIX D Bus Module and Loop Module Diagnostic LED's Definition

There are three LEDs on the Bus Module to indicate the status of the configuration port (RS232), module (MS) and network (NS). On the loop modules there is 1 LED per loop so for a 4 loop module there are 4 diagnostic LED's. The following tables show the LED state, description and meaning.

D1 Bus Module Configuration port LED (RS232)

LED State	Description	Meaning
OFF	No Power	There is no power supplied to the Bus Module
Green	Power ON and OK	There is power supplied to the Bus Module and no communications
Red	Power ON and Bus ready alarm is present	There is power supplied to the Bus Module and there is a fault on the communication
Green flashing	Communications established	There is successful communications between the PC and the Bus Module
Red/Green flashing	Communications established and Bus ready alarm	There are errors in the communications

D2 MODBUS RTU LED Diagnostics

Module Status (MS)

LED State	Description	Meaning
OFF	No Power	There is no power supplied to the Bus Module
Green	Power ON and OK	There is power supplied to the Bus Module and there are no problems. (normal operation)
Red	Power ON and a Fault	There is power supplied to the Bus Module and there is a fault on the MODBUS port including incoming CRC errors

Network Status (NS)

LED State	Description	Meaning
OFF	No Comms	No communications
Green Flashing	Power ON and communications in progress	There is power supplied to the Bus Module and there is normal MODBUS communications in progress. (normal operation)
Red	Communication Errors	There are errors present in the MODBUS packets

D3 DeviceNet LED Diagnostics

Module Status (MS)

LED State	Description	Meaning
OFF	No Power	There is no power supplied to the Bus Module
Green	Power ON and OK	The Bus Module is under normal operating conditions
Red	Unrecoverable Fault	The Bus Module has an unrecoverable fault
Green flashing	Standby	The Bus Module has not been configured
Red flashing	Minor Fault	There is a minor fault with the Bus Module which can be recovered from.
Red/Green flashing	Bus Module self testing	The Bus Module is performing a self test

Network Status (NS)

LED State	Description	Meaning
OFF	No Power/Not Online	Online, duplicate MAC ID test not completed
Green	Online, connected	Online and has been allocated a master
Red	Critical link failure	Failed communication; bus fault or power-up self-test failed. (duplicate MAC ID, or Bus-off)
Green flashing	Online, not connected	Normal condition, on-line with no connections in the established state; has not been allocated a Master.
Red flashing	Connection time-out	One or more I/O connections are in the timed-out state
Red/Green flashing	Communication faulted and received an identify comm fault request	A specific communication faulted device. The Bus Module has detected a network access error and is in the communication faulted state.

If more help is needed, refer to the DeviceNet diagnostics section of your PLC manufacturer's software/hardware manuals.

D4 PROFIBUS LED Diagnostics

Module Status (MS)

LED State	Description	Meaning
OFF	No Power	There is no power supplied to the Bus Module
Green	Power ON and OK	The Bus Module is under normal operating conditions
Green flashing	Standby	No Master Device or error in establishing connection
Orange	Error	Unrecoverable communications error cycle the power to the MLC 9000+

Network Status (NS)

LED State	Description	Meaning
OFF	No Power	There is no power supplied to the Bus Module
Red	Power on with Error	No Lead connected to Profibus Port
Red Flashing	Loss of Network Connection	Has lost connection from previously connected Network
Green	Online, connected	Online and has been allocated a master

If more help is needed, refer to the PROFIBUS diagnostics section of your PLC manufacturer's software/hardware manuals.

D5 Ethernet/IP LED Diagnostics

Module Status (MS)

LED State	Description	Meaning
OFF	No Power	There is no power supplied to the Bus Module
Green	Power ON and OK	The Bus Module is under normal operating conditions
Red	Unrecoverable Fault	The Bus Module has an unrecoverable fault (contact your local technical support)
Green flashing	Standby	The Bus Module has not been configured
Red flashing	Minor Fault	There is a minor fault with the Bus Module which can be recovered from.
Red/Green flashing	Bus Module self testing	The Bus Module is performing a self test

Network Status (NS)

LED State	Description	Meaning
OFF	No Power/Not Online	Online, duplicate MAC ID test not completed
Green	Online, connected	Online and has been allocated a master
Red	Critical link failure	Failed communication; bus fault or power-up self-test failed. (duplicate MAC ID, or Bus-off)
Green flashing	Online, not connected	Normal condition, on-line with no connections in the established state; has not been allocated a Master.
Red flashing	Connection time-out	One or more I/O connections are in the timed-out state
Red/Green flashing	Communication faulted and received an identify comm fault request	A specific communication faulted device. The Bus Module has detected a network access error and is in the communication faulted state.

If more help is needed, refer to the Ethernet/IP diagnostics section of your PLC manufacturer's software/hardware manuals.

D6 MODBUS/TCP LED Diagnostics**Module Status (MS)**

LED State	Description	Meaning
OFF	No Power	There is no power supplied to the Bus Module
Green	Power ON and OK	There is power supplied to the Bus Module and there are no problems. (normal operation)
Red	Power ON and a Fault	There is power supplied to the Bus Module and there is a fault on the MODBUS/TCP port.

Network Status (NS)

LED State	Description	Meaning
OFF	No Network Connection	There is no Ethernet connection to the Bus Module
Green Flashing	Network Connected but no master assigned	Normal condition, on-line with no connections in the established state; has not been allocated a Master.
Green	Online, connected	Online and has been allocated a master
Red flashing	Connection time-out	One or more I/O connections are in the timed-out state

D8 Loop Module LED Diagnostics

LED State	Description	Meaning
Red Flashing Slow	Power not Addressed	Loop Module powered but not addressed by the Bus Module
Red Flashing Fast	Addressed with no Configuration	Loop Module is addressed but has no configuration
Green	Operational with no errors	Loop Module is configured with no errors
Red/Green Flashing	Sensor Break	The Loop input has a Sensor Break condition
OFF	Loop Inhibited or no power	The loop is in an inhibited state refer to section 4.4.2.



BRITAIN

WEST INSTRUMENTS/ CAL HENGSTLER SA Controls

The Hyde Business Park,
Brighton
East Sussex
BN2 4JU
England

Tel:
+44 (0) 1273 606271

Fax:
+44 (0) 1273 609990

www.westinstruments.com
info@westinstruments.com



FRANCE

ZI des Mardelles
94 à 106 rue Blaise
Pascal
93602 Aulnay-sous-Bois
CEDEX
France

Tel:
+33 (1) 48-79-55-00

Fax:
+33(1) 48-79-55-61

www.hengstler.fr



GERMANY

PMA Prozeß- und Maschinen- Automation GmbH

Miramstraße 87
D-34123 Kassel
Deutschland

Tel:
+49 (561) 505-1307

Fax:
+49 (561) 505-1710

www.pma-online.de
mailbox@pma-online.de



USA

DANAHER CONTROLS

1675 Delany Road
Gurnee
IL 60031-1282
USA

Tel:
847 662 2666

Fax:
847 662 6633

www.dancon.com
dancon@dancon.com

CHINA

Danaher Setra-ICG (Tianjin) Co., Ltd.

No.28 Wei 5 Road,
The Micro-Electronic Industry
Park TEDA
Xiqing District
Tianjin 300385
China

Tel:
+86 22 8398 8096

Fax:
+86 22 8398 8099

www.danaher-scg.com.cn

JAPAN

DANAHER ICG JAPAN

2-12-23 Minamikaneden
Suita-shi
Osaka
564-0044
Japan

Tel:
+81 6 386 8001

Fax:
+81 3 386 5022

www.danaher.co.jp

ITALY

CD AUTOMATION

Via Picasso, 34/36
20025 Legnano (MI)

Tel.
+39 0331 577479

Fax.
+39 0331 579479

www.cdautomation.com

SPAIN

CARLO GAVAZZI, S.A.

Avda. Iparraguire, 80-82
48940 Leioa (Bizkaia)
Spain

Tel:
+34 94 480 40 37

Fax:
+34 94 480 10 61

www.carlogavazzi.com/ac
gavazzi@carlogavazzi-sa.es