

MEASUREMENT SENSORS



High precision quality inspection

HIGH PRECISION MEASUREMENT
MESURE DE HAUTE PRÉCISION
H PRECISION MEASUREMENT
R LA MISURA ALTA PRECISIONE PER LA MISURA
ERIL ESTO CORE VULLAN
ОТЧОЧНОЕ ИЗМЕРЕНИЕ ВЫСОКОТОЧНОЕ ИЗМЕРЕНИЕ
MESURE DE HAUTE PRÉCISION
PRECISION MEASUREMENT
SURE DE HAUTE PRÉCISION
PRECISIONE PER LA MISURA-EX-ERIL ESTO CORE VULLAN

realizing



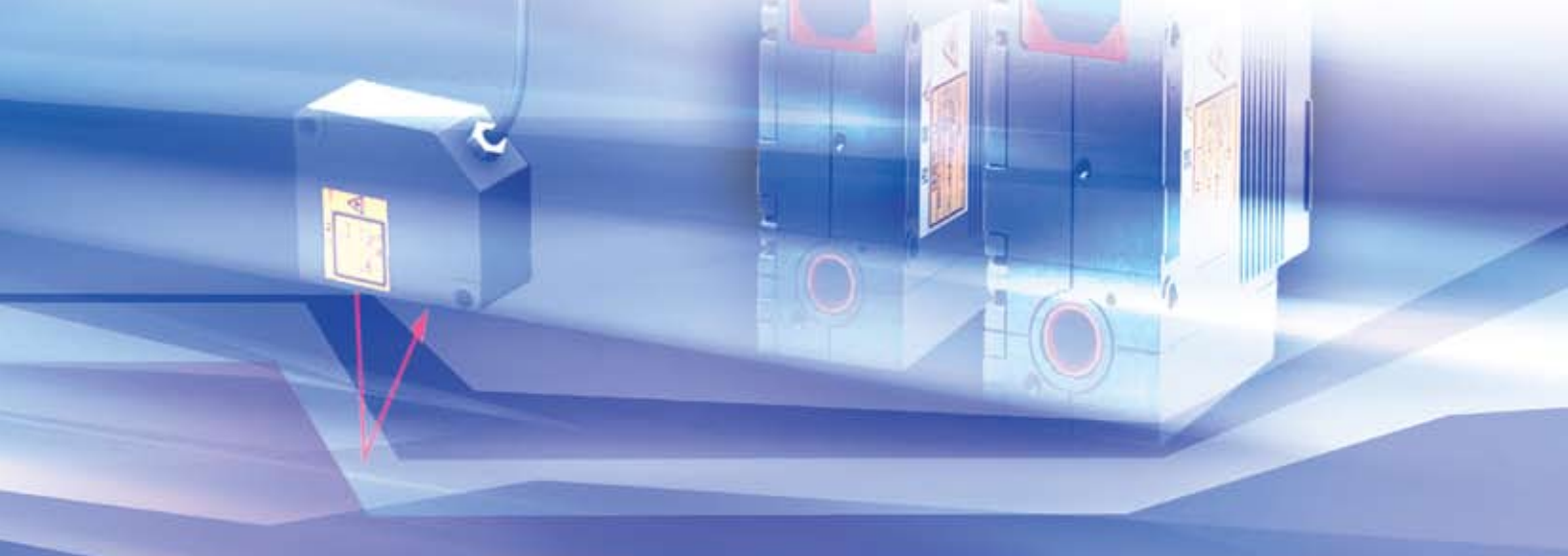

High performance in the 3 measurement disciplines

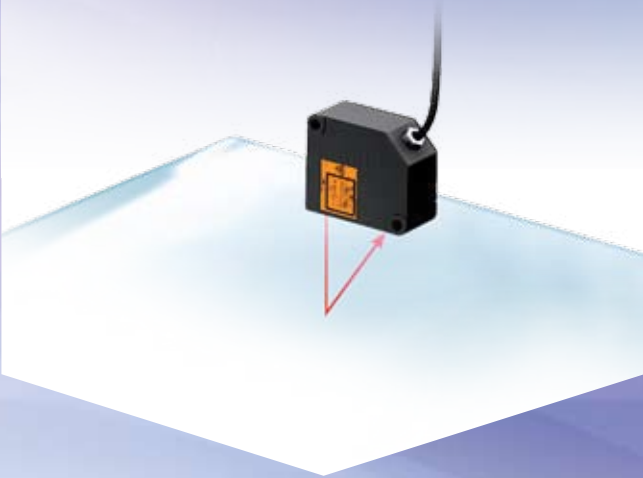

DISPLACEMENT/DISTANCE

Accurate measurement of distances can be done by laser triangulation, inductive or tactile principles. The Smart sensors ZX and ZS represent a powerful platform matching the accuracy and technology, which is required for this application.



PROFILE MEASUREMENT

Scan the profile of an object with a laser beam. Depending of the height, the laser beam is reflected differently and creates the profile information.

By moving the sensor or the object, the complete surface can be inspected. The Smart profile sensors ZG provides an easy to use solution.

NEVER FAIL IN MEASUREMENT

Customer satisfaction highly depends on the quality of the finished goods or the performance of the machine in use. Zero defects in production is a key criterion for success. The speed of production lines is getting increasingly faster. On the other hand the machines should never fail. But can you trust the result?

To ensure highest inspection performance these smart measurement sensors offer accurate, reliable and fast measurement. Various inspection principles and technologies always provide the best solution for your application.

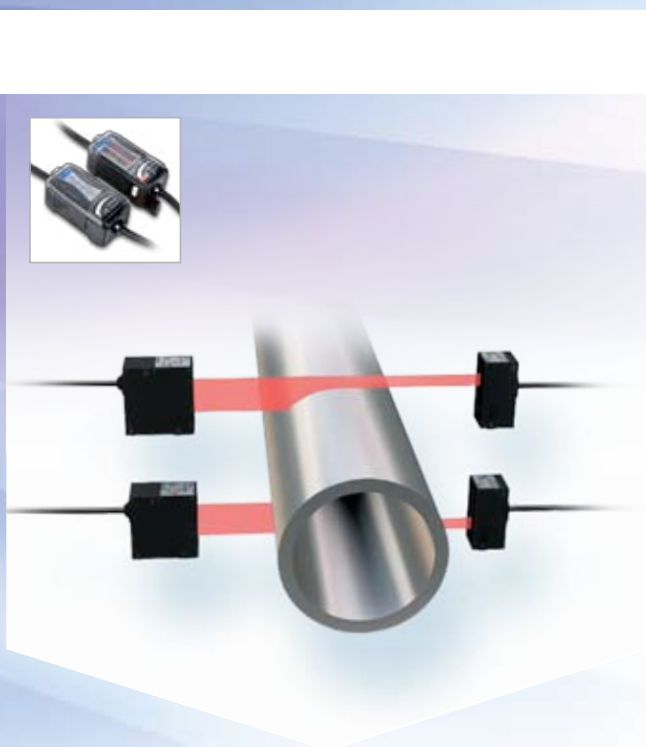

POSITION/DIAMETER/WIDTH

Determine accurately the position or diameter of an object. The object interrupts the laser beam, which allows the edges of an object to be determined. The smart laser micrometer ZX-GT is the perfect choice for this task.

Displacement/distance measurement

- ▶ **ZS-series** 4
All in one – smart, accurate and scalable
- ▶ **ZX-series** 6
Smart sensing in different technologies

Profile measurement

- ▶ **ZG-Series** 8
Easy profile measurement

Position/diameter/width measurement

- ▶ **ZX-GT Smart Laser Micrometer** 10
Accurate and fast on all surfaces



YOUR BENEFITS

- One sensor – any surface and distance
- One controller – multi-tasking
- One software – remote control
- One solution – any application

ZS-SERIES – ALL IN ONE – SMART, ACCURATE & SCALABLE

The ZS laser sensor family provides outstanding measurement performance on all kind of materials. Its huge range of sensor heads and scalable concept makes it a versatile platform for all high precision sensing applications. The ZS-series features an unique sensor head for glass inspections, which simplifies mounting and allows measurements even on round glass.



▲ Black rubber thickness inspection

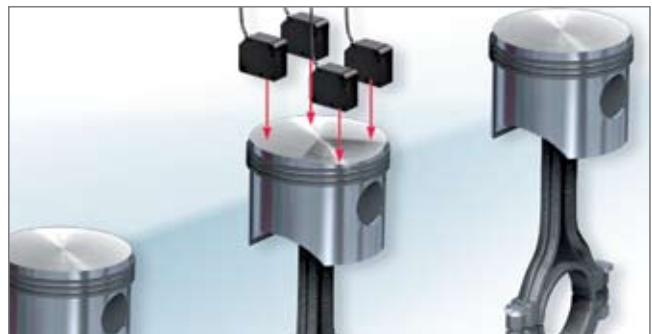

▲ Piston evenness inspection

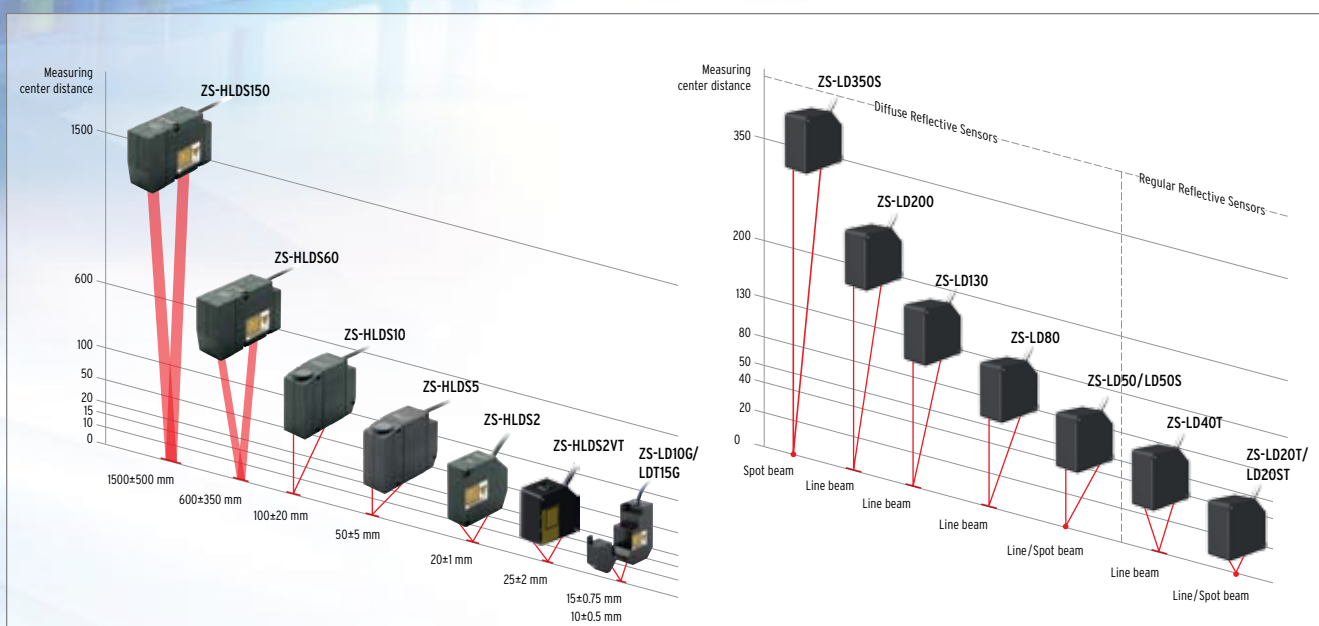
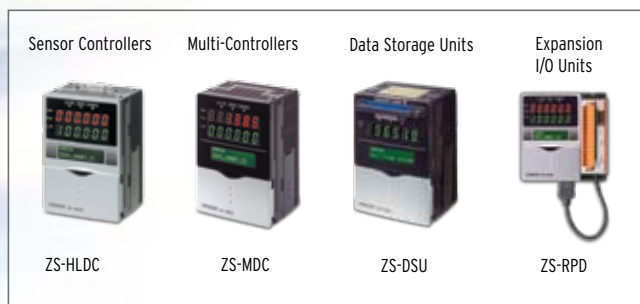

14 x sensor heads for any purpose:

- Flexible sensing distance: from 10 mm to 1.500 mm
- High accuracy: 0,25 – 5 μm
- Difficult surfaces: glass, shiny metal, black rubber, etc.
- Measure multiple surfaces of transparent objects
- CMOS technology

Powerful controller:

- LCD display for setup and immediate result display
- Fast sampling time: 110 μs
- Multi-tasking enabled by a single controller
- Scalability of up to 9 controllers (heads)
- Multi-controller unit (MDC)
- Remote control via communication interfaces and PC software

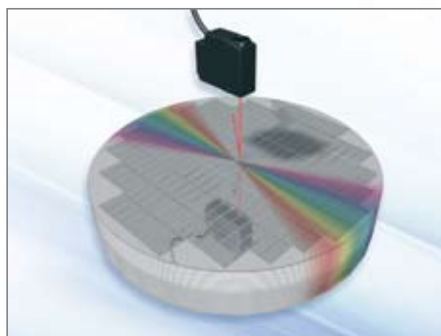

▲ Wafer thickness and warping inspection

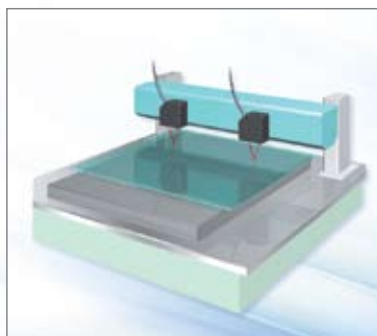

▲ Glass evenness inspection



▲ Disk surface inspection



YOUR BENEFITS

- Modular platform
- Combine tactile, inductive and laser sensors
- Plug and play – interchangeable sensor heads
- Multi-point measurements
- Calculate and communicate
- Digital I/Os and analogue outputs

ZX-SERIES- SMART SENSING IN DIFFERENT TECHNOLOGIES

The ZX displacement sensor platform offers a variety of interchangeable sensor heads, including laser, inductive and contact types. They can be easily connected to a standard amplifier.

Simply select the sensor head that fits your application based on material and accuracy. The easy exchange of sensor heads reduces installation time and saves maintenance costs.

The modular platform enables different sensing technologies to be combined in one platform. The easy set-up of ZX can be done with the amplifier or by the intuitive Smart Monitor PC software.

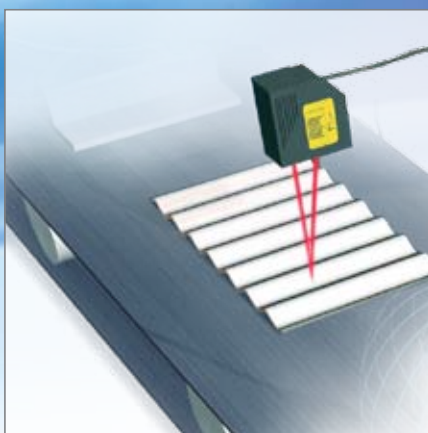

▲ Measurement of structured surfaces



▲ Eccentricity control of a rotating shaft



▲ Thickness measurement

ZX-L – smart laser displacement

- Sensing range from 2 mm – 500 mm
- High resolution
- Fast response time
- Surfaces: plastic, metal, paper, rubber, etc.

ZX-E – smart inductive displacement

- High resolution of 1 μm
- Sensing range from 0.5 mm – 7 mm
- High linearity for any metal
- Mutual interference prevention
- Thickness, evenness, warpage measurement

ZX-T – Smart contact measurement

- Wide range of heads and contact tips
- Long life ball bearing structure
- High resolution of 0.1 μm
- Pressing force alarm to prevent malfunctions

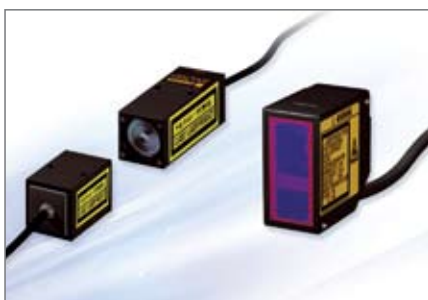

PROFILE MEASUREMENT

1 Adjust sensor head
Check on LCD display



2 Select function
Simple ICON menu



3 Select range
Automatic calculation

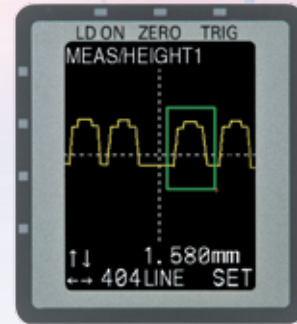

▲ 3 step setting up of measurement via built-in LCD display

YOUR BENEFITS

- Intuitive – easy to use
- Live – LCD monitor for display and setup
- Versatile – 18 tools
- Accurate – 5 μ m resolution
- Wide profiles – up to 70 mm
- Stable measurements on challenging surfaces

ZG-SERIES - EASY PROFILE MEASUREMENT

The new ZG smart sensor demonstrates that profile measurement with easy operation is no longer impossible. The built-in LCD monitor for an easy and intuitive user interface supports efficient installation and setup. Immediate live feedback of the measurement result is provided in real time. Advanced measurement tasks can be configured within 3 steps to save operation and setting-up time. The fine tuning of the settings can be achieved in seconds.

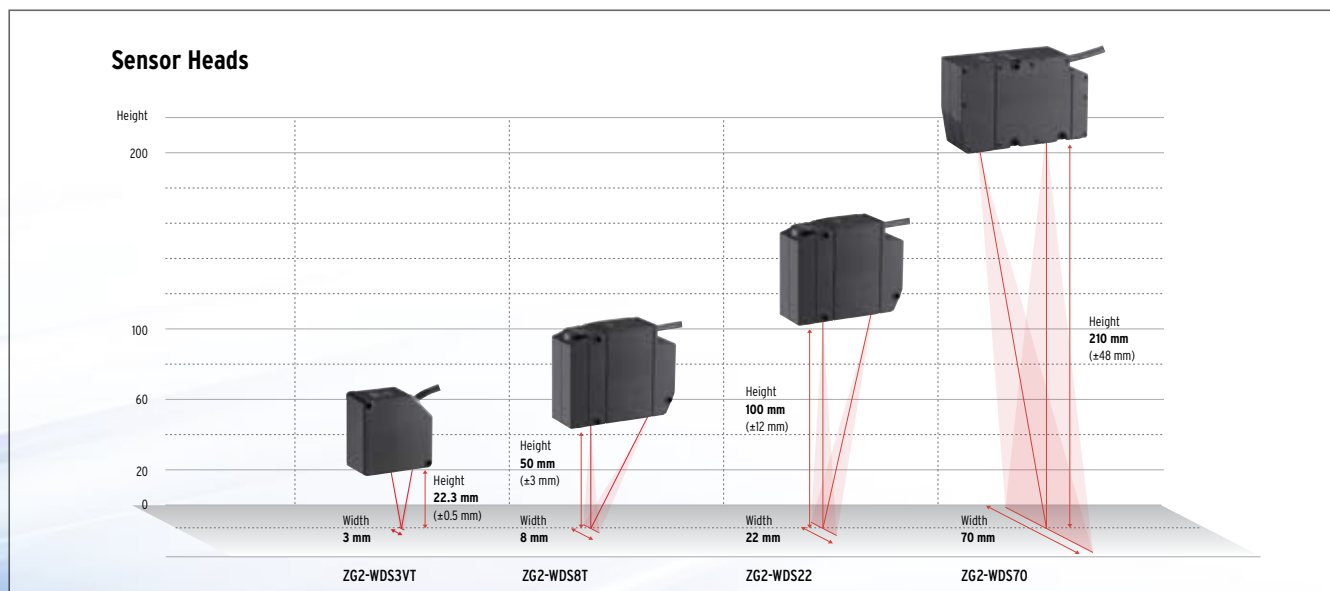

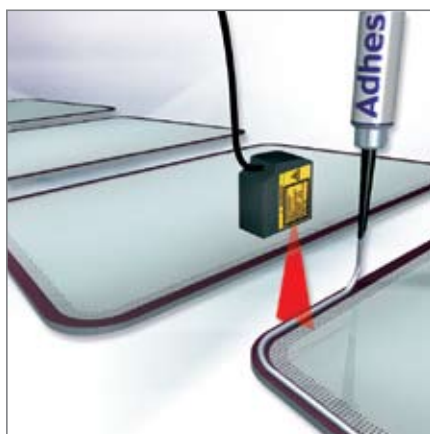

▲ Glue seam inspection



▲ Precise gap measurement in automotive industry



▲ Checking the shape of vehicle structural parts. The wide beam allows the measurement in a single operation.

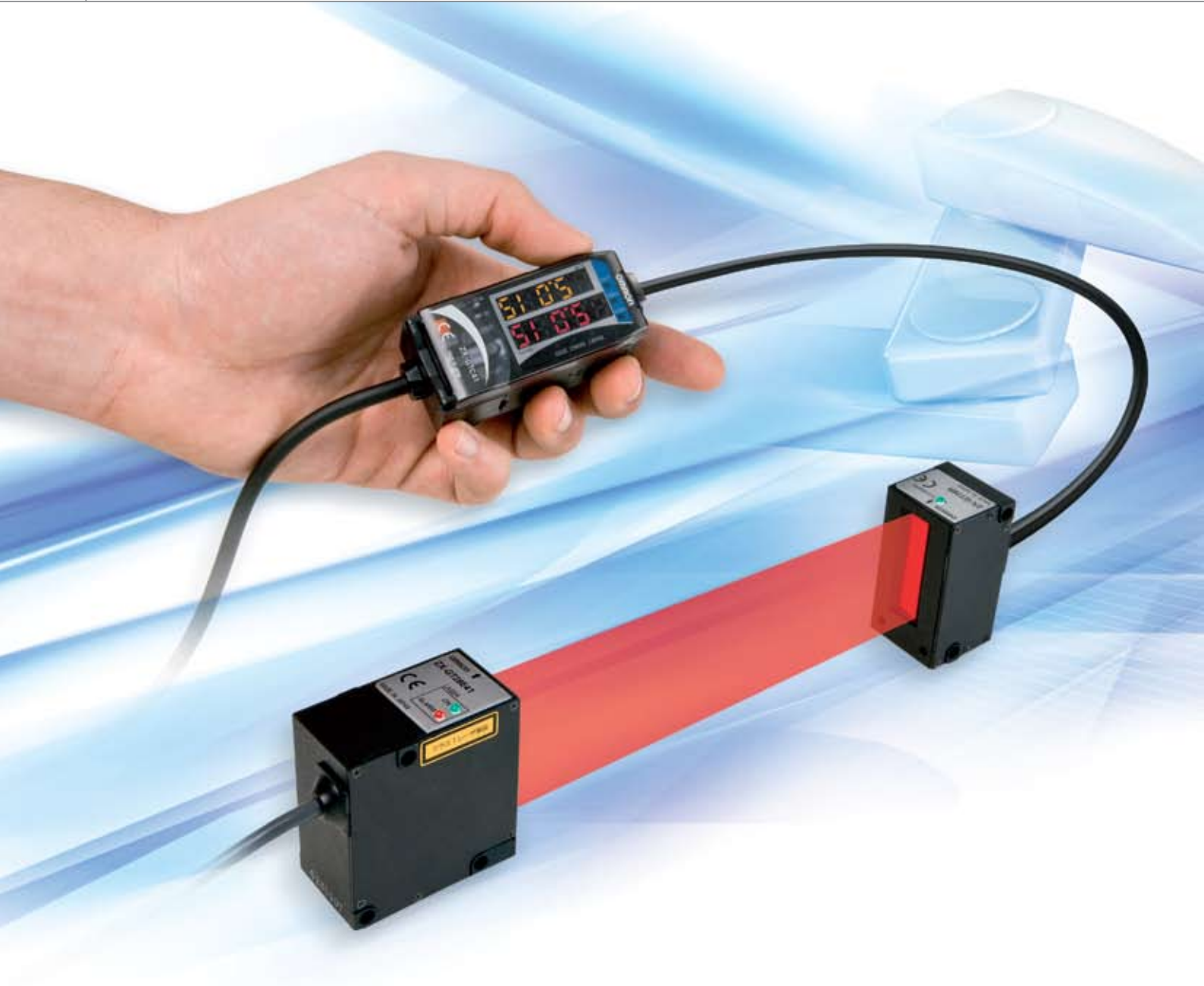

YOUR BENEFITS

- High accuracy: 10 μm
- All surfaces
- Long sensing distance: < 500 mm
- Line width up to 28 mm
- Calculation unit for multiple heads

ZX-GT SMART LASER MICROMETER: ACCURATE AND FAST ON ALL SURFACES

The new ZX-GT smart laser micrometer complements Omron's Smart Laser Measurement platform. ZX-GT is able to detect edges, measure diameters of objects and calculate precisely the position on all kind of materials. Based on CCD technology ZX-GT achieves high accuracy and speed under difficult environmental conditions. Transparent objects, reflective surfaces or different positions do not have an influence on the result. The PC Smart Monitor software helps to easily setup and configure the laser micrometer.

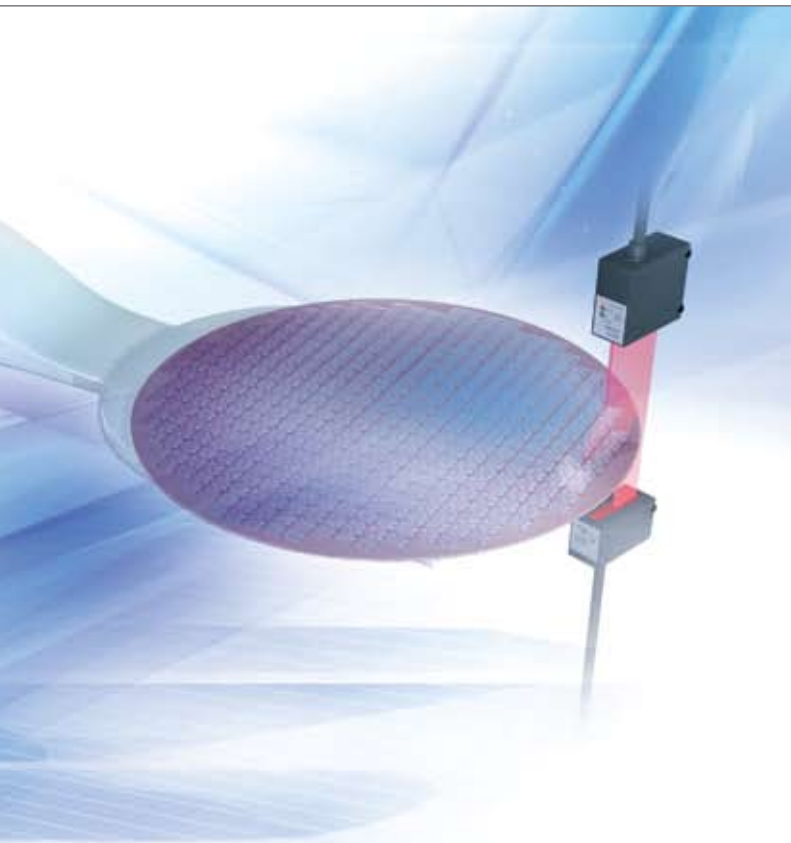

▲ Modular and scalable

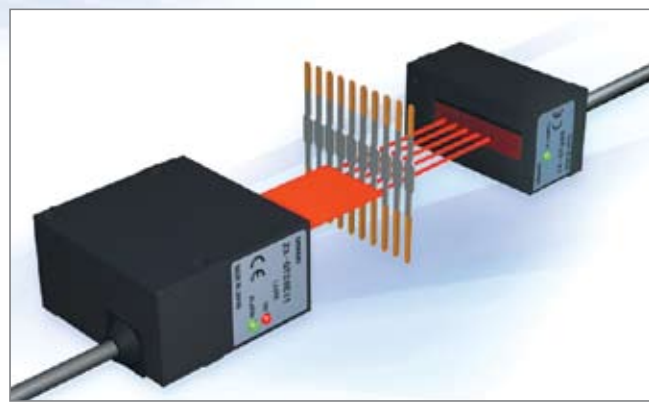

▲ Electronic components - lead-pitch and diameter measurement

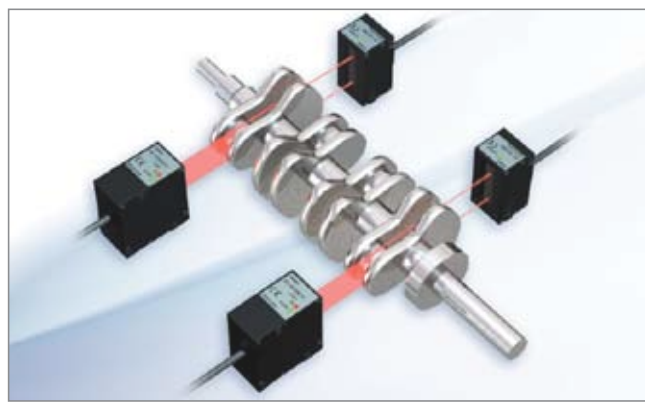

▲ Automotive - diameter inspection of large tubes

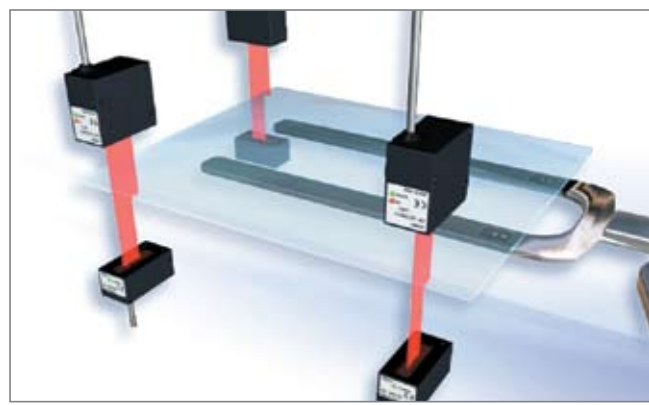

▲ LCD - glass-edge measurement

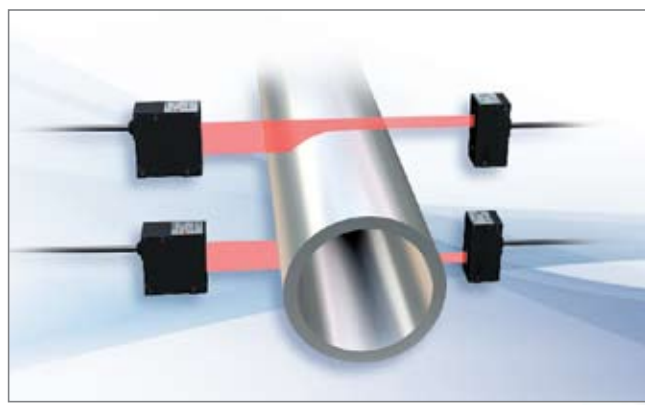

▲ Automotive - diameter measurement of large-scale pipe

OMRON EUROPE B.V. Wegalaan 67-69, NL-2132 JD, Hoofddorp, The Netherlands. Tel: +31 (0) 23 568 13 00 Fax: +31 (0) 23 568 13 88 www.industrial.omron.eu

Austria

Tel: +43 (0) 2236 377 800
www.industrial.omron.at

Belgium

Tel: +32 (0) 2 466 24 80
www.industrial.omron.be

Czech Republic

Tel: +420 234 602 602
www.industrial.omron.cz

Denmark

Tel: +45 43 44 00 11
www.industrial.omron.dk

Finland

Tel: +358 (0) 207 464 200
www.industrial.omron.fi

France

Tel: +33 (0) 1 56 63 70 00
www.industrial.omron.fr

Germany

Tel: +49 (0) 2173 680 00
www.industrial.omron.de

Hungary

Tel: +36 1 399 30 50
www.industrial.omron.hu

Italy

Tel: +39 02 326 81
www.industrial.omron.it

Netherlands

Tel: +31 (0) 23 568 11 00
www.industrial.omron.nl

Norway

Tel: +47 (0) 22 65 75 00
www.industrial.omron.no

Poland

Tel: +48 (0) 22 645 78 60
www.industrial.omron.pl

Portugal

Tel: +351 21 942 94 00
www.industrial.omron.pt

Russia

Tel: +7 495 648 94 50
www.industrial.omron.ru

South-Africa

Tel: +27 (0)11 579 2600
www.industrial.omron.co.za

Spain

Tel: +34 913 777 900
www.industrial.omron.es

Sweden

Tel: +46 (0) 8 632 35 00
www.industrial.omron.se

Switzerland

Tel: +41 (0) 41 748 13 13
www.industrial.omron.ch

Turkey

Tel: +90 216 474 00 40
www.industrial.omron.com.tr

United Kingdom

Tel: +44 (0) 870 752 08 61
www.industrial.omron.co.uk

More Omron representatives
www.industrial.omron.eu

Authorised Distributor:

Control Systems

- Programmable logic controllers • Human-machine interfaces • Remote I/O

Motion & Drives

- Motion controllers • Servo systems • Inverters

Control Components

- Temperature controllers • Power supplies • Timers • Counters • Programmable relays
- Digital panel indicators • Electromechanical relays • Monitoring products • Solid-state relays
- Limit switches • Pushbutton switches • Low voltage switch gear

Sensing & Safety

- Photoelectric sensors • Inductive sensors • Capacitive & pressure sensors
- Cable connectors • Displacement & width-measuring sensors • Vision systems
- Safety networks • Safety sensors • Safety units/relay units • Safety door/guard lock switches