



---

**DS2**



**Instruction Manual**

---



ORIGINAL INSTRUCTIONS (ref. 2006/42/EC)

Datalogic Automation S.r.l.  
Via Lavino, 265  
40050 - Monte S. Pietro  
Bologna - Italy

DS2 Instruction Manual

Ed.: 05/2014

© 2012 Datalogic Automation S.r.l. □ ALL RIGHTS RESERVED. □ Protected to the fullest extent under U.S. and international laws. Copying, or altering of this document is prohibited without express written consent from Datalogic Automation S.r.l.

Datalogic and the Datalogic logo are registered trademarks of Datalogic S.p.A. in many countries, including the U.S.A. and the E.U.

All brand and product names mentioned herein are for identification purposes only and may be trademarks or registered trademarks of their respective owners.

Datalogic shall not be liable for technical or editorial errors or omissions contained herein, nor for incidental or consequential damages resulting from the use of this material.

06/05/14



**Datalogic Automation S.r.l.**

Via Lavino 265

40050 Monte San Pietro

Bologna - Italy

[www.automation.datalogic.com](http://www.automation.datalogic.com)

*declares that the*

**DS2 ; OBJECT DETECTION AND MEASUREMENT LIGHT GRID**

*and all its models*

*are in conformity with the requirements of the European Council Directives listed below:*

**2004 / 108 / EC EMC Directive**

*This Declaration is based upon compliance of the products to the following standards:*

- EN 60947-5-2, Ed.3 DECEMBER 2007:** *LOW-VOLTAGE SWITCHGEAR AND CONTROLGEAR.  
PART 5: CONTROL CIRCUIT DEVICES AND SWITCHING.  
SECTION 2: PROXIMITY SWITCHES  
PRODUCT STANDARD IS IDENTICAL TO: IEC 60947-5-2, OCTOBER 2007*
- EN 61000-6-2, SEPTEMBER 2005:** *ELECTROMAGNETIC COMPATIBILITY (EMC)  
PART 6-2: GENERIC STANDARDS - IMMUNITY FOR INDUSTRIAL ENVIRONMENTS*
- EN 55011 ( CLASS A ISM ), MARCH 2007:** *INDUSTRIAL, SCIENTIFIC AND MEDICAL (ISM) RADIO-FREQUENCY EQUIPMENT -  
ELECTROMAGNETIC DISTURBANCE CHARACTERISTICS - LIMITS AND METHODS  
OF MEASUREMENT*

Monte San Pietro, April, 23th 2010

Paolo Morselli  
Quality Manager



# INDEX

---

|   |           |
|---|-----------|
| <b>1. GENERAL INFORMATION</b> .....   | <b>1</b>  |
| 1.1. General description of the AREAscan™ light grid .....                          | 1         |
| 1.2. Selecting the device .....   | 2         |
| 1.3. Typical applications .....   | 3         |
| <b>2. INSTALLATION MODES</b> .....  | <b>4</b>  |
| 2.1. Precautions to be observed for the choice and installation of the device ..... | 4         |
| 2.2. General information on device positioning .....                                | 4         |
| 2.2.1. <i>Minimum installation distance</i> .....                                   | 4         |
| 2.2.2. <i>Minimum distance from reflecting surfaces</i> .....                       | 5         |
| 2.2.3. <i>Installation of several adjacent light grids</i> .....                    | 6         |
| <b>3. MECHANICAL MOUNTING</b> .....   | <b>7</b>  |
| <b>4. ELECTRICAL connections</b> .....  | <b>8</b>  |
| 4.1. Notes on connections .....   | 9         |
| <b>5. FUNCTIONING MODES</b> .....   | <b>10</b> |
| 5.1. Detection mode .....   | 10        |
| 5.2. Measurement mode .....   | 10        |
| 5.3. Transition detection (number of transitions) .....                             | 11        |
| 5.4. Notes on functioning mode .....  | 11        |
| 5.5. RS485 serial output setting .....  | 12        |
| <b>6. FUNCTION AND PROGRAMMING SELECTION</b> .....                                  | <b>12</b> |
| 6.1. Local programming .....  | 13        |
| 6.1.1. <i>Teach-in with detection</i> .....   | 14        |
| 6.1.2. <i>Absolute detection mode</i> .....   | 15        |
| 6.1.3. <i>Relative detection mode</i> .....   | 16        |
| 6.2. Remote programming .....   | 17        |
| 6.2.1. <i>DS2 user interface – General information</i> .....                        | 18        |
| 6.2.2. <i>Program installation</i> .....  | 18        |
| 6.2.3. <i>Graphic user interface</i> .....  | 19        |
| 6.2.4. <i>Connection with AREAscan™ DS2 series</i> .....                            | 19        |
| 6.2.5. <i>Configuration of the AREAscan™ DS2 series</i> .....                       | 23        |
| 6.2.6. <i>File saving of the configuration options</i> .....                        | 28        |
| 6.2.7. <i>File loading of the configuration options</i> .....                       | 28        |
| <b>7. AREAscan™ DS2 series – communication Protocol</b> .....                       | <b>29</b> |
| 7.1. Packet description .....   | 29        |
| 7.1.1. <i>Binary data packet structure</i> .....                                    | 29        |
| 7.1.2. <i>Short protocol binary data packet structure</i> .....                     | 29        |
| 7.1.3. <i>ASCII data packet structure</i> .....                                     | 29        |
| 7.2. Operating mode: DS2 (master) → Host Interface (slave) .....                    | 30        |
| 7.2.1. <i>Packet description</i> .....  | 30        |
| 7.3. Configuration mode: DS2 (slave) ← Host (master) .....                          | 33        |
| 7.3.1. <i>Host appropriation procedure of the bus</i> .....                         | 33        |
| 7.3.2. <i>Command packet description</i> .....                                      | 34        |
| <b>8. DIAGNOSTIC FUNCTIONS AND LED INTERFACE ERROR SIGNALLING</b> .....             | <b>40</b> |
| 8.1. Device status visualisation .....  | 40        |
| <b>9. CHECKS AND PERIODICAL MAINTENANCE</b> .....                                   | <b>41</b> |
| <b>10. TECHNICAL DATA</b> .....   | <b>42</b> |
| 10.1. Response time .....   | 42        |
| <b>11. LIST OF AVAILABLE MODELS</b> .....   | <b>43</b> |
| <b>12. OVERALL DIMENSIONS</b> .....   | <b>43</b> |

## 1. GENERAL INFORMATION

### 1.1. General description of the AREAscan™ light grid



The AREAscan™ light grids are multibeam optoelectronic devices that can be used to detect objects, including small and transparent targets as well as for measurement detection. The variety of functions implemented make the DS2 a particularly flexible device that suits many different applications.

The AREAscan™ light grids of the DS2 series are manufactured in accordance with the international Standards in force and in particular:

**CEI EN 60947-5-2:** low voltage proximity devices

**CEI EN 50319:** proximity switches: requirements for proximity switches with analogue output

The device, consisting of emitter and receiver units housed inside sturdy aluminium profiles, generates infrared beams that detect any object positioned in the light grid's detection field.

The command and control functions are inside the two units; the connections are made through M12 connectors located in the lower side of the profiles.

The synchronisation between the emitter and the receiver takes place via cable through direct connection between the two units.

The control and management of the emitted and received beams are guaranteed by microprocessors. The operator obtains information relative to the light grid status and error conditions through LEDs located on the device and/or through the control interface of a remote PC.

Some parts or paragraphs of this manual, containing important information for the operator, are preceded by a note:



Notes and detailed descriptions about particular characteristics of the AREAscan™ devices have been added to better explain functioning.

DATALOGIC AUTOMATION Technical Support is available for questions related to the functioning and installation of the DS2 series light grids and for any information and/or suggestions necessary for a correct installation (see section 9 "*Checks and periodical maintenance*").



**AREAscan™ ARE NOT safety devices; the use of the device for safety purposes and operator safeguarding is not conform and dangerous.**

## 1.2. Selecting the device

The selection of the correct device version is linked to the detection area needed, which is considered as the sensitive area height of the device as well as to the maximum operating distance, considered as the distance between the emitter unit (TX) and receiver unit (RX) and optics interaxis.

Versions are available:

|                         | <i>Operating distance</i> | <i>Detection field</i> | <i>interaxis</i> |
|-------------------------|---------------------------|------------------------|------------------|
| <b>DS2-05-07-015-JV</b> | 5m                        | 21 beams; h=150mm      | 6.75mm           |
| <b>DS2-05-07-030-JV</b> | 5m                        | 42 beams; h=300mm      | 6.75mm           |
| <b>DS2-05-07-045-JV</b> | 5m                        | 63 beams; h=450mm      | 6.75mm           |
| <b>DS2-05-07-060-JV</b> | 5m                        | 84 beams; h=600mm      | 6.75mm           |
| <b>DS2-05-07-075-JV</b> | 5m                        | 105 beams; h=750mm     | 6.75mm           |
| <b>DS2-05-07-090-JV</b> | 5m                        | 126 beams; h=900mm     | 6.75mm           |
| <b>DS2-05-07-105-JV</b> | 5m                        | 147 beams; h=1050mm    | 6.75mm           |
| <b>DS2-05-07-120-JV</b> | 5m                        | 168 beams; h=1200mm    | 6.75mm           |
| <b>DS2-05-07-135-JV</b> | 5m                        | 189 beams; h=1350mm    | 6.75mm           |
| <b>DS2-05-07-150-JV</b> | 5m                        | 210 beams; h=1500mm    | 6.75mm           |
| <b>DS2-05-07-165-JV</b> | 5m                        | 231 beams; h=1650mm    | 6.75mm           |
|                         |                           |                        |                  |
| <b>DS2-05-25-045-JV</b> | 10m                       | 18 beams; h=450mm      | 25mm             |
| <b>DS2-05-25-060-JV</b> | 10m                       | 24 beams; h=600mm      | 25mm             |
| <b>DS2-05-25-075-JV</b> | 10m                       | 30 beams; h=750mm      | 25mm             |
| <b>DS2-05-25-090-JV</b> | 10m                       | 36 beams; h=900mm      | 25mm             |



The functions characterising the DS2 **AREAscan™** light grids are available on all the versions that consequently have the same operating modes.

The specific technical characteristics (e.g. resolution, sensitivity etc) remain the same for all the versions, until differently indicated.



For food industry applications, please verify with DATALOGIC AUTOMATION Technical Support the compatibility of the materials of the light grid shell with the eventual chemical agents that are used in the production process.

### 1.3. Typical applications

The following images supply an overview on some main applications.

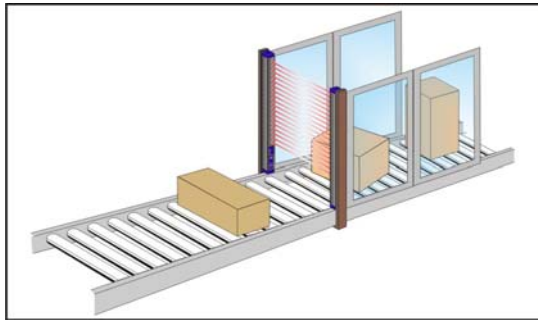

*Object detection and measurement on conveyor belt*

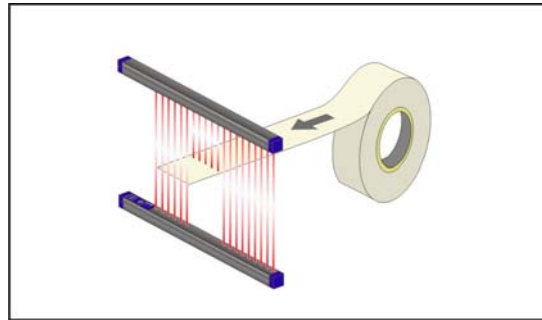

*Control of the correct material positioning (opaque and transparent) during functioning (plastic, metal, paper etc)*

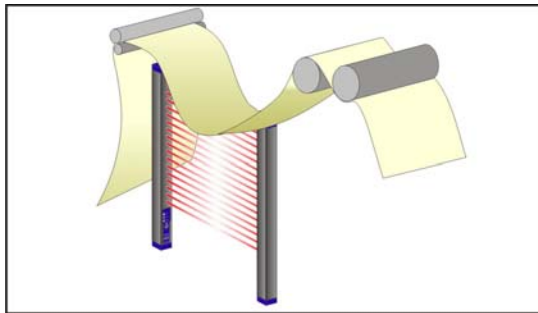

*Loop control and positioning (also transparent material)*

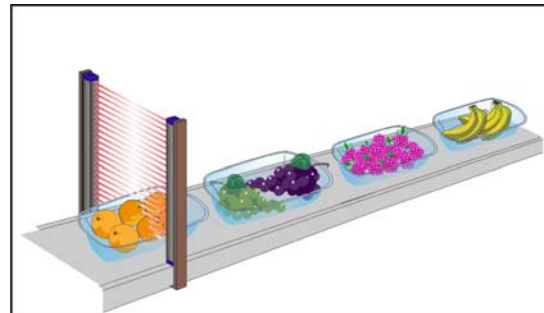

*Detection of objects with different shapes in the food industry*

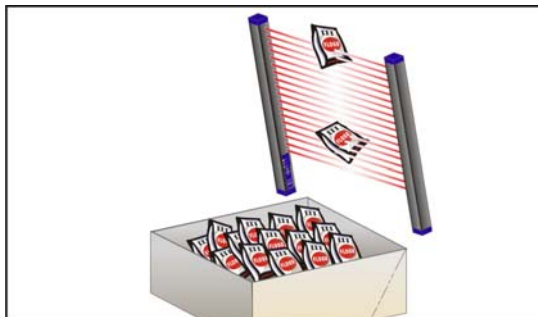

*Detection of objects in different positions (parallel beams)*

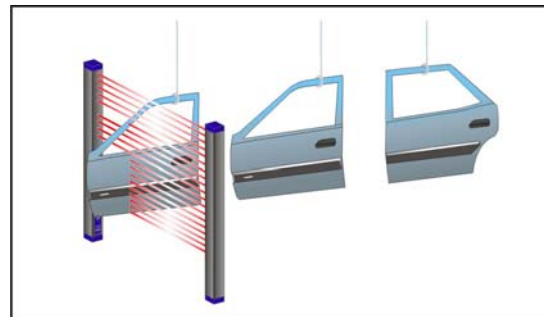

*Detection of slots and holes in different positions*

## 2 INSTALLATION MODES

### 2.1. Precautions to be observed for the choice and installation of the device

- The dimension of the smallest object to be detected should not to be lower than the resolution level of the device.
- The DS2 should be installed in a place compatible with the technical characteristics (see section 10 "*Technical Data*") of the **AREAscan**<sup>™</sup> light grids.

Other considerations:

- avoid installation near very intense and/or flashing light sources, in particular near the receiver unit.
- strong electromagnetic interference can compromise the correct functioning of the device. Please contact DATALOGIC AUTOMATION Technical Service when this problem occurs.
- the operating distance of the device can be reduced in the presence of smog, fog or airborne dust.
- a sudden change in environment temperature, with very low minimum peaks, can generate a small condensation layer on the lenses and jeopardise functioning.
- relevant variations of the power supply can reduce the operating distance of the device.

### 2.2. General information on device positioning

- Place the device near the detection area.
- Align the receiver (RX) and emitter (TX) units in order that they are the most parallel possible. Verify that the green receiver LED is on (stability condition), otherwise slight adjustments of both units have to be made in order to reach the stability position.
- Fix the receiver and emitter units on rigid supports not conditioned by strong vibrations using specific fixing brackets (see section 3 "*Mechanical mounting*")
- Check that the distance between the receiver and emitter units is within the device operating distance (see section 10 "*Technical data*")

#### 2.2.1. *Minimum installation distance*

The minimum installation distance corresponds to the minimum operating distance = 0.3 m.



**2.2.2. Minimum distance from reflecting surfaces**

Reflecting surfaces placed near light beams of the AREAScan™ device (over, under or laterally) may cause passive reflections that can compromise the detection of an object inside the controlled area (see Fig.1).

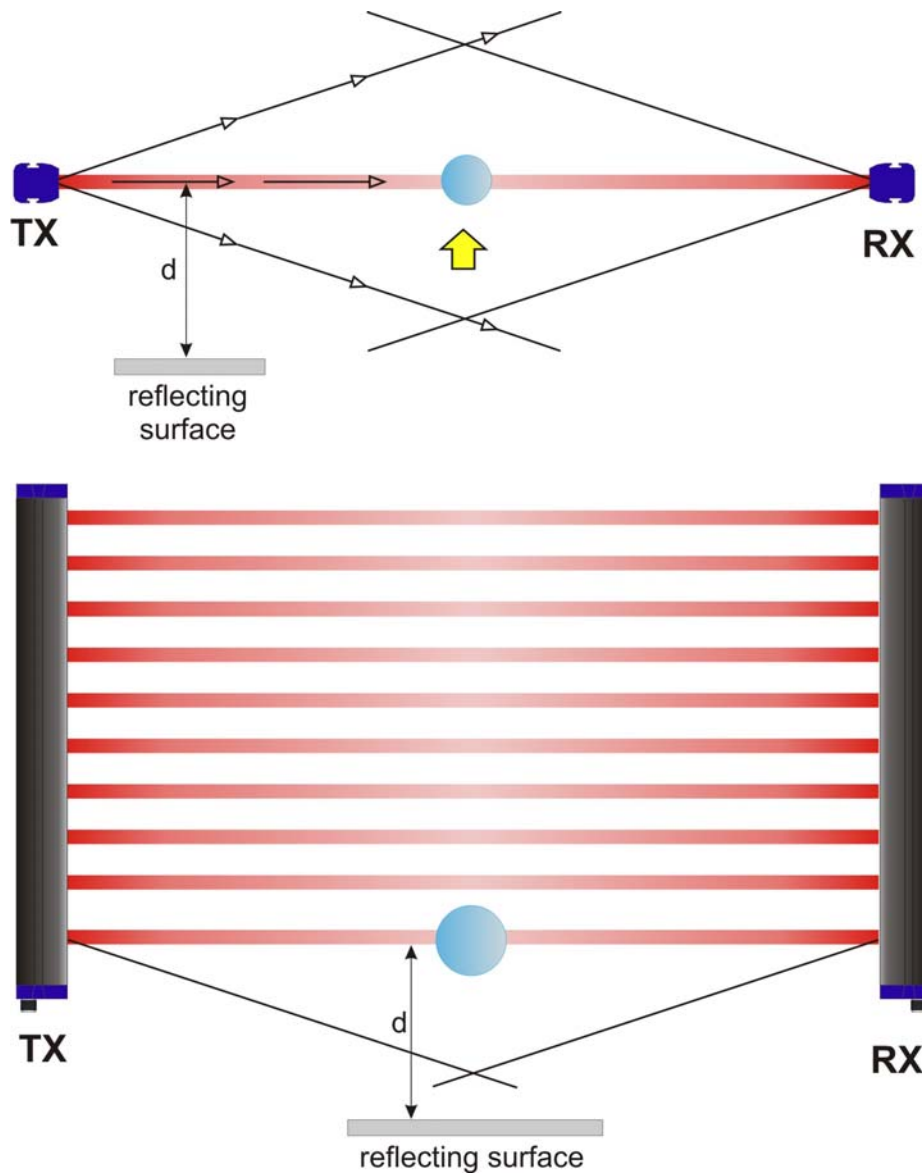

**Fig. 1**

However, the object may not be detected if the receiver detects a secondary beam (reflected by the side-reflecting surface), even if the entering object interrupts the main beam.

It is thus important to position the units at the correct distance from any reflecting surface:

The minimum distance depends on:

- device operating distance
- reflecting surface nature
- position of the object inside the sensitive area

It is necessary to evaluate this distance on the field according to the operating conditions; however a minimum distance from the reflecting surface of about 0.5 m is suggested.

2.2.3. *Installation of several adjacent light grids*

When several devices must be installed in adjacent areas, it is necessary to prevent the interference between the emitter of one device and the receiver of another.

Fig.2 provides an installation example of possible interference between different devices and two possible solutions.

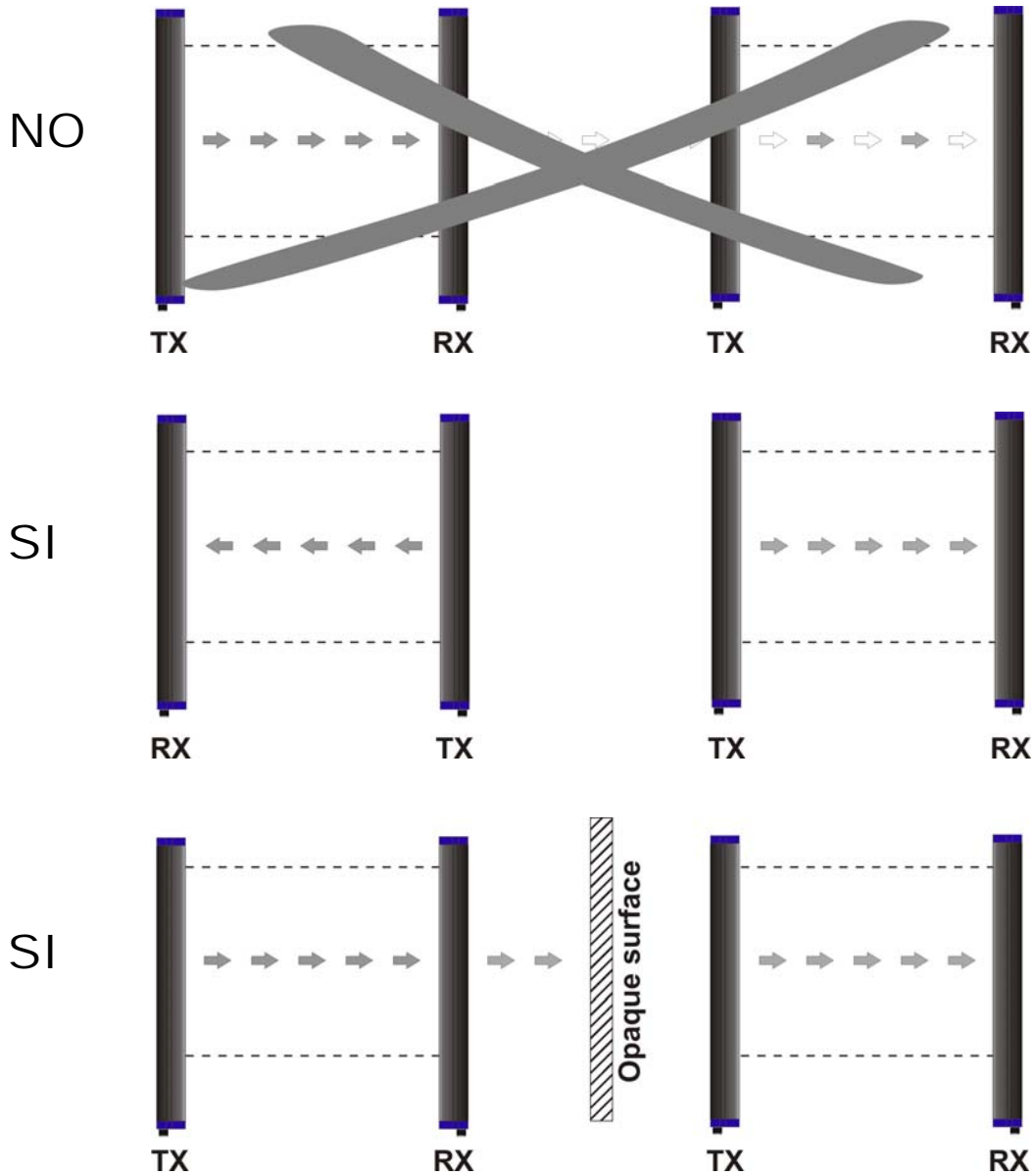

Fig. 2

### 3. MECHANICAL MOUNTING

The emitter and receiver units have to be mounted with the relevant sensitive surfaces facing each other. The connectors must be positioned on the same side and with the operating distance of the model used (see section 10 "Technical data").

The two units must be aligned and parallel as much as possible.

To mount the device, insert the threaded pins supplied (see Fig.3) in the slots present on the two units.

Depending on the particular application and/or type of support, the operator can use the fixing pins or the rigid fixing brackets supplied to mount the two units (see Fig.4).

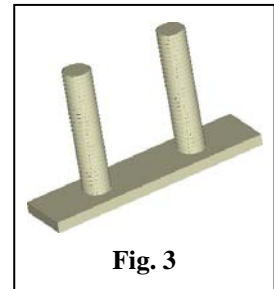

Fig. 3



Fig. 4

Rigid fixing brackets can be used where no big mechanical corrections are required during the alignment operation.

Rotating supports for the correction of the unit inclination of  $\pm 1^\circ$  on the medial transversal axis and of  $\pm 5^\circ$  on the longitudinal axis, are available on request.

In applications with particularly strong vibrations, the use of anti-vibration shock absorbers able to reduce the impact of vibrations together with threaded pins, rigid brackets and/or rotating supports are recommended.

#### 4. ELECTRICAL CONNECTIONS

The electrical connection between the emitting and receiving units is made through a male M12 connector located in the lower part of the light grid.

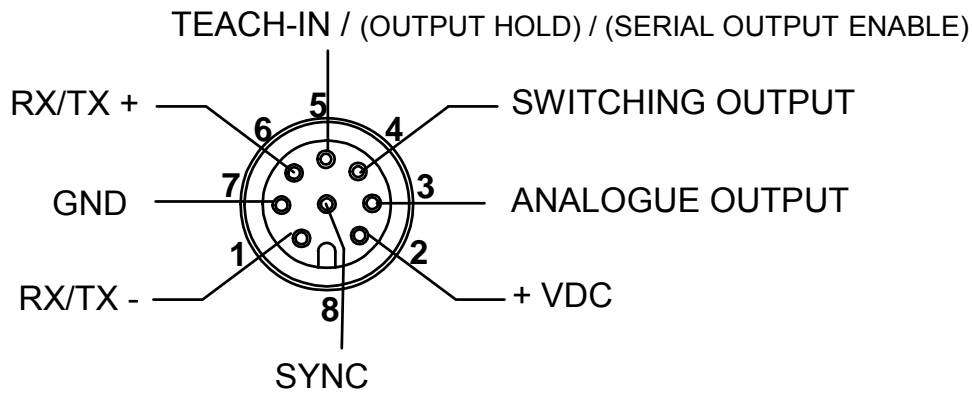

#### **RECEIVER (RX):**

|            |   |
|------------|---|
| 1 = white  | = RX/TX -                                     |
| 2 = brown  | = +VDC  |
| 3 = green  | = ANALOGUE OUT                                |
| 4 = yellow | = SWITCHING OUTPUT                            |
| 5 = grey   | = TEACH-IN / (OUT HOLD) / (SERIAL OUT ENABLE) |
| 6 = pink   | = RX/TX +                                     |
| 7 = blue   | = GND   |
| 8 = red    | = SYNC  |

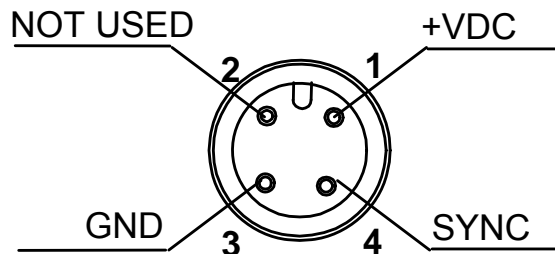

#### **EMITTER (TX):**

|           |            |
|-----------|------------|
| 1 = brown | = +VDC     |
| 2 = white | = NOT USED |
| 3 = blue  | = GND      |
| 4 = black | = SYNC     |

4.1. Notes on connections

The following precautions regarding electrical connections have to be respected for the correct functioning of the **AREAscan™** light grid.



- Shielded cables are not foreseen in the standard connection. However, if necessary, these cables can be used in presence of ground connection of both the unit and cable, as shown in Fig.5.

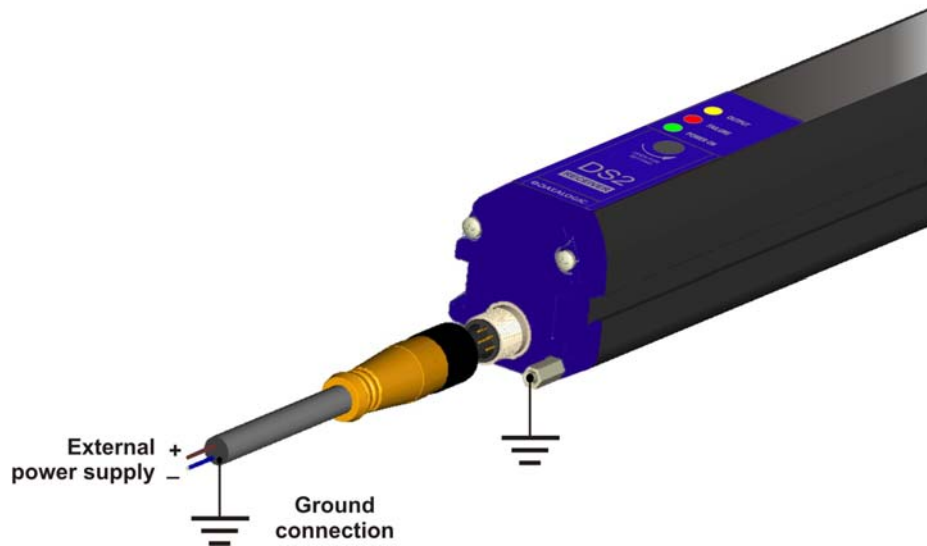

Fig. 5



- In any case, these cables must not be placed in contact with or near any high voltage cables (e.g. motor power supplies, inverters, etc) that, generating strong electromagnetic fields, can compromise the correct functioning of the device.
- Ground connection of the two units is not necessary. However, if required, the connection is possible tightening the specific screw supplied instead of one of the 8 screws that lock the heads of each unit (see Fig.6).
- Follow the connection illustrated in Fig.5 when ground connection of the entire system is used.



Fig. 6

## 5. FUNCTIONING MODES

The DS2 light grids detect and measure objects placed inside the detection area. Hence, beam interruptions can cause output switching, analogue output signal variation and serial output updating. Small objects (up to 12 mm) detection and geometrical measurements determined with approximately 6 mm resolution can be obtained by setting the device according to the different functioning modes. Beam scanning is sequential and the update of all the outputs is made at each scanning, within a period equal to the device response time.

### 5.1. Detection mode

The detection mode is activated whenever at least one beam is interrupted inside the detection area. The activation causes the digital output switching (signalled by the powering of the yellow LED). The DS2 presents many different functions, listed below, that condition the switching output:

- **Switching Output Mode:** indicates if electrical current passes through switching output; the output can be normally closed (**N.C.**) or normally open (**N.O.**).
- **Switching Output Delay:** delays the re-setting of the switching output after detection. The delay time can be selected.
- **Acquisition and detection (Teach-in):** allows a conditioned detection of the object inside the detection area: if the object corresponds (without resolution) to the object detected during the Teach-in phase, the output switches. On the contrary nothing happens. The following modes can be set:
  - **absolute Teach-in detection:** the output switches only if the previously set object is re-detected in the same position.
  - **relative Teach-in detection:** the output switches only if the previously set object (without resolution) is re-detected, independently from the position in the sensing area.

### 5.2. Measurement mode

The measurement mode depends on the number of interrupted beams and causes the switching of the analogue output and of the serial output (and also of the digital output). The DS2 presents many different measurement functions, listed here below:

- **Absolute measurements:** measurement is obtained considering the first photoelement (1) as the reference beam beginning from the connector side. The DS2 light grid has in particular the following functions:
  1. **top beam:** provides the measurement between the reference beam and the obscured beam furthest away from the reference
  2. **bottom beam:** provides the measurement from the reference beam and the obscured beam closest to the reference
  3. **middle beam:** provides the measurement of the beam corresponding to the medium point between the obscured beam furthest away from the reference and the obscured beam closest to the reference
- **Relative measurements:** measurement is obtained not considering absolute references. The measurement depends on the number of obscured beams. The DS2 light grid has in particular the following functions:
  4. **total beams:** supplies the measurement corresponding to the total number of obscured beams
  5. **total contiguous beams:** supplies the measurement corresponding to the maximum number of contiguous beams obscured

**5.3. Transition detection (number of transitions)**

The transition detection counts the number of transitions in the detection area. The number of transition increases each time that an object is detected inside the detection area and decreases each time the objects remain outside (*transition light->dark*).

**5.4. Notes on functioning mode**

- The DS2 light grids can configure the beam reference status, specifically selecting it from the user interface. The default selection is “dark beam”, but the operator can select the complementary situation i.e. “light beam”.
- Not all the functions can be selected using dip-switches. Please refer to the following tables to discover the local programmability of the device.
- The 0-10 V analogue output, supplies limited information if compared to the information that can be obtained from the serial output; some functions are significant only if obtained in a serial ambient. The analogue voltage value is supplied, in these cases, without direct correspondence, as indicated in the tables found in page 12, 24 and 26.  
The formula to determine the voltage is obtained with the following syntax:

$$V_{OUT} = V_{RES} * N_{BEAM} [xxx ; yyy]$$

Where  $V_{OUT}$  = voltage value of the analogue output  
 $V_{RES}$  = 10V/total n° of beams of the device = Voltage value corresponding to the minimum resolution (obtained obscuring only one beam)  
 $N_{BEAM} [xxx ; yyy]$  = Number of beams belonging to the group [XY]  
*(i.e. between “xxx” beam and “yyy” beam)*

*Please note that the longer DS2 is, the less conditioning is  $V_{RES}$ . In the worst case  $V_{RES} = 43 mV$  ! (using the DS2 165 model)*

The first reference beam to select, **by using only dip-switches**, can be the one closest beam (default reference) or the one furthest away from the connector, located at the opposite side of the unit where the analogue voltage is at the minimum level (**positive ramp 0-10 V**) or maximum (**negative ramp 10-0V**) in correspondence of the obscuring of the default reference beam.

Fig. 10 can be used as an example, considering a device with 10 beams, where the obscuring of one beam corresponds to the  $V_{OUT}$  variation of 1V ( $V_{RES} = 1V$ ). At last beam obscuring, the  $V_{OUT}$  reaches 10 V full scale.

If the first beam is selected as the reference, the  $V_{OUT}$  in the example is = 6 V. If the last beam is selected as the reference, the  $V_{OUT}$  in the example is = 7 V (B).

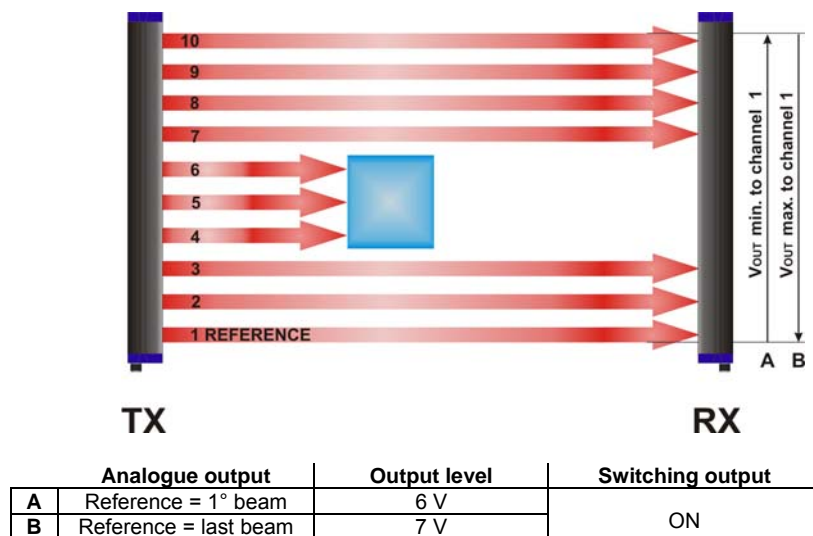

Fig. 7

The information can be obtained from the serial output, setting the top beam and bottom beam measurement modes.

### 5.5. RS485 serial output setting

Serial output data updating is usually made at the end of each scanning cycle. This conditions enormously the response time, as it is depends on the serial baud-rate, data structure and information detail that has to be transmitted on the serial output for the application. Some serial configuration commands have been added to make the device flexible to different applications. The remote user interface completely controls these commands.

- **Baud-rate:** allows the change of the serial switching speed. The 485 standard guarantees excellent disturbance immunity and thus the increase of the transmission speed may compromise the system. The speed has to be evaluated according to the application, plant and cabling.
- **Transmission standard selection:** the *ASCII* or *Binary* data structure transmitted by the serial output can be selected; in applications where time is important, the binary structure is preferred. For details concerning data transmission please see section 7 “*Communication protocol*”.
- **Data partition selection:** allows a partial serial data transmission. In particular, the transmission of the complete beam status array or partial beam status array is distinguished: The two conditions exclude each other (one or the other). If the partial transmission is selected, one of the aforementioned measurement modes has to be chosen. Partial transmission is preferred for applications where time factors are important. Further partial transmission is **short protocol** which transmission is purely binary and extremely fast. Fuction is enable for single measure only. For data transmission details please see section 7 “*Communication protocol*”.
- **Data sending mode selection:** function allows the operator to choose when to send the data from the serial output. The sending can also be inhibited by a specific selection (via “software”, using the specific command, via “hardware” programming the **serial output enable** input – pin 5 RX connector – using the user interface). The sending mode selection can be reached only via remote control. Four options can be selected: **data sending at each machine cycle** which is the default setting, **data sending at each output status change**, **data sending at analogue output value change**, **user sending request**, using the interface command button. This last condition can be requested also by an external command previously programming the device (per details please see section 7 “*Communication protocol*”).

## 6. FUNCTION AND PROGRAMMING SELECTION

The functions implemented in the **AREAscan™** DS2 light grids can be selected using the dip-switches present on the device receiving unit or via remote. The default configurations are given below:

- **Default configuration for receiver unit**

The device is supplied with the standard configuration shown in the figure:



- **Default configuration for emitter unit**

The device is supplied with the maximum emission adjustment setting (minimum sensitivity)



- **Sensitivity adjustment**

Sensitivity adjustment is made using the trimmer located inside the emitter unit lid. This function allows the operator to change the emitter intensity.





6.1. Local programming



The function programming and selection is made using dip-switches located inside the receiver unit lid.

The following table indicates the type of function and relative position of the dip-switches.



| Dip N. | Function                         | Active   | Setting |   | Output  |   |                            |
|--------|----------------------------------|----------|---------|---|---|---|----------------------------|
|        |                                  |          | Pos     | Mode  | Analogue  | Switching                                       | Serial                     |
| 1A     | Programming mode                 | Run Time | ON      | Local   | -   | -   | -                          |
|        |                                  |          | OFF     | Remote  | See remote setting  |   |                            |
| 2A     | Serial output analysis mode      | Start-up | ON      | Complete                                      | -   | -   | Complete Beam Status Array |
|        |                                  |          | OFF     | Partial                                       | -   | -   | Partial ASCII              |
| 3A     | Measurement reference beam       | Start-up | ON      | Reference = First Beam (closest to connector) | $V = V_{Res} * N_{BEAM}$ [Top; ref]<br>Incr. Ramp(0-10V)      | -   | Partial Top Beam           |
|        |                                  |          | OFF     | Reference = Last Beam                         | $V = 10 - V_{Res} * N_{BEAM}$ [Top; ref]<br>Decr. Ramp(10-0V) | -   | Partial Bottom Beam        |
| 4A     | Measurement analysis beam        | Start-up | ON      | Top or Bottom (Absolute Measure)              | -   | -   | -                          |
|        |                                  |          | OFF     | Total (Relative Measure)                      | $V = V_{Res} * N_{BEAM}$ [dark]                               | -   | Partial Total Beam         |
| 1B     | Teach-in detection analysis mode | Start-up | ON      | Inactive Teach-in (Normal mode)               | -   | Presence detection                              | -                          |
|        |                                  |          | OFF     | Active Teach-in                               | -   | Conditional presence detection from Teach-in    | -                          |
| 2B     | Teach-in Mode                    | Start-up | ON      | Absolute pos. detection                       | -   | Positional detection of Teach-in ref. object    | -                          |
|        |                                  |          | OFF     | Relative pos. detection                       | -   | Detection of Teach-in reference object          | -                          |
| 3B     | Switching Output Mode            | Start-up | ON      | Normally Open                                 | -   | Voltage on switching device during detection    | -                          |
|        |                                  |          | OFF     | Normally Closed                               | -   | No voltage on switching device during detection | -                          |
| 4B     | Switching Output Delay           | Start-up | ON      | No Delay                                      | -   | -   | -                          |
|        |                                  |          | OFF     | 100ms   | -   | Restore from detection delay = 100ms            | -                          |

(-) Shows that the state of considered dip-switch does not influence kind of output correlated; output is old setting by state of function of the others dip-switches.

The functions, with the exception of the programming mode, cannot be activated during device functioning. The functions are activated at device powering.

### 6.1.1. Teach-in with detection

The Teach-in mode can be selected using dip-switches and using remote user interface.

For local programming of the Teach-in mode, the Teach-in wire should be connected to a push-button normally open on the 24 V line and proceed as follows:

- Select the **Teach-in enable** mode (dip switch 1B OFF).
- Switching output deactivated
- Place object inside the detection area at the desired position
- Press the push-button.
- Release the push-button only after switching output deactivation (yellow receiver LED on)

The object detection will be signalled by the switching on of the yellow LED in presence of the object.

**The detected object (in the detection position) is stored in a non-volatile memory until a successive detection.**

**The data is memorised also after device turning off and re-powering.**

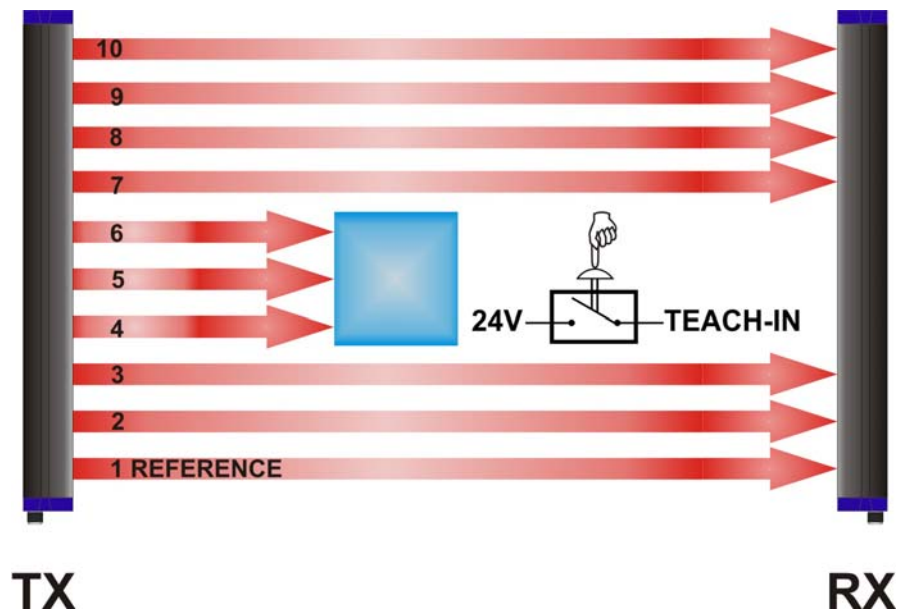

Fig. 8

6.1.2. Absolute detection mode

The digital output switches only if the object, whose dimensions have been previously memorised, passes in the exact position where it has been previously detected (see Fig.9).

The analogue output is always active in this configuration and supplies a voltage value according to the measurement setting.

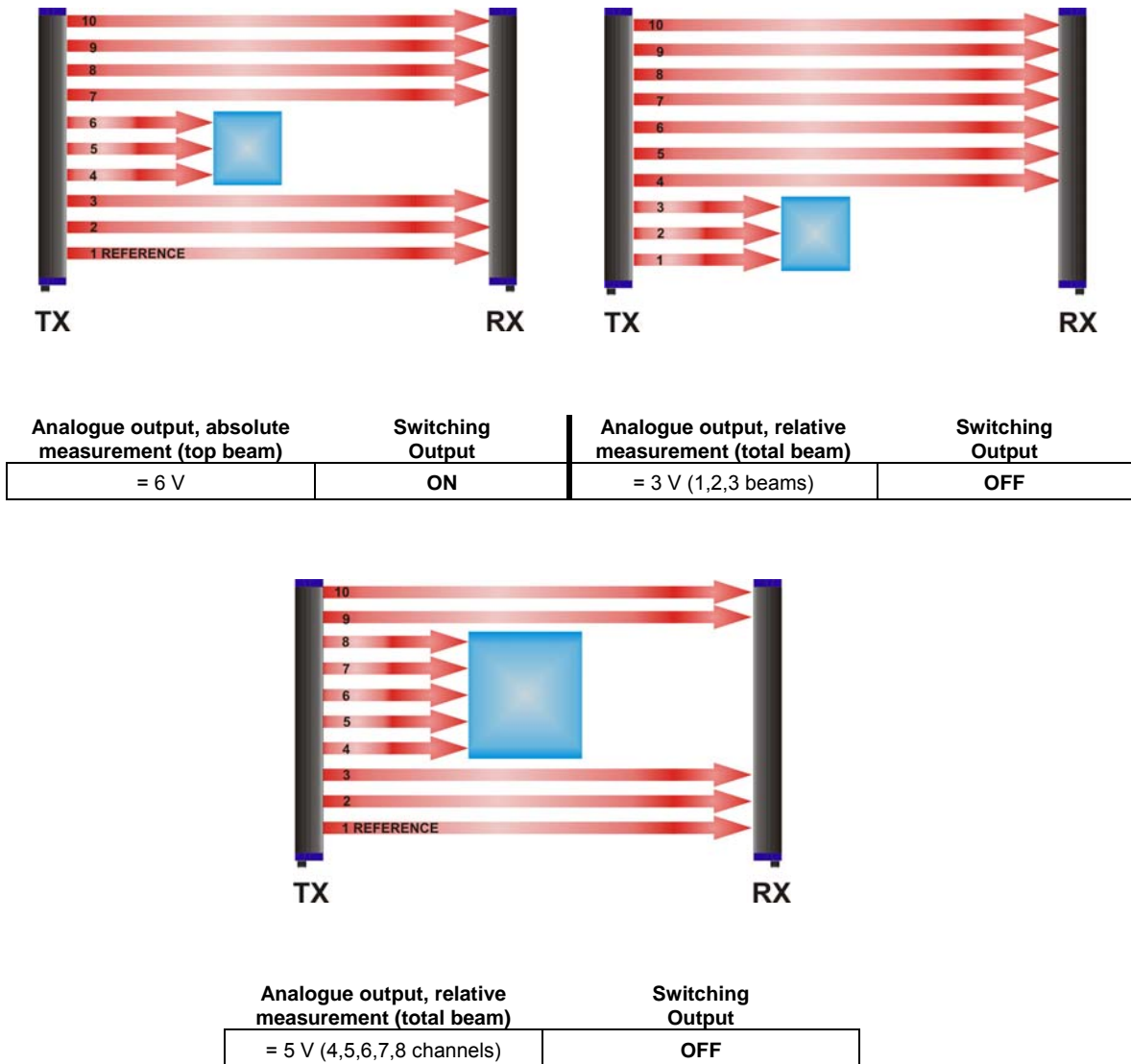

Fig. 9

**6.1.3. Relative detection mode**

The digital PNP output switches each time the sample object passes through the sensitive area, independently from its position (see Fig.10).

The analogue output is always active in this configuration and supplies a voltage value according to the measurement setting.

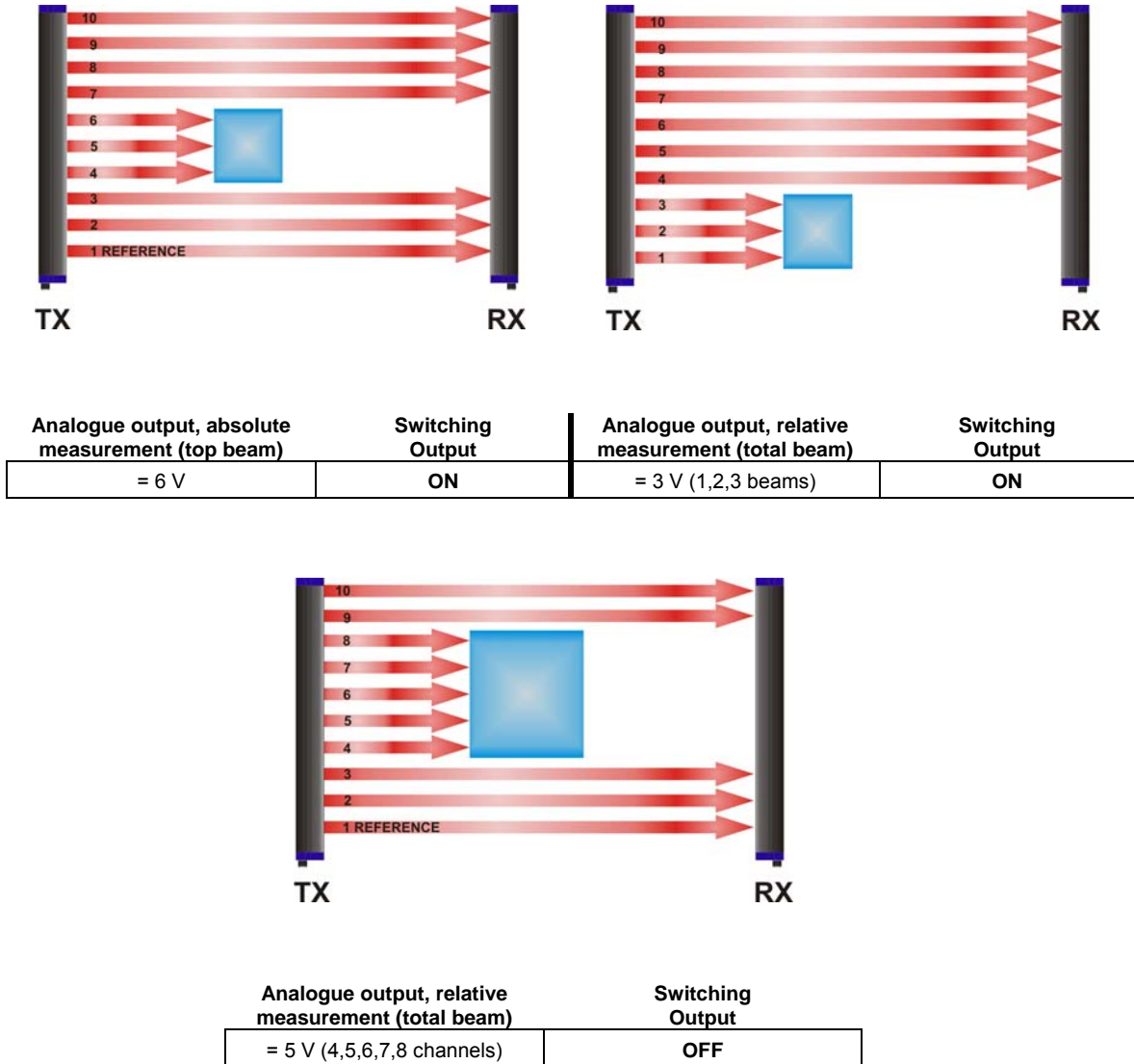

Fig. 10

### 6.2. Remote programming

The function programming and selection is made using an user interface on a remote host, which communicates with DS2 using the standard RS232 serial interface. The interface can be found in the CD supplied with the device packet.

The remote programming function selection is activated only by dip-switches (dip-switch 1Aoff)

**N.B.:** DS2 device fix in memory the last setting configuration from remote user interface. At the first interface startup, DS2 set it self following the factory configuration which is eventually restoring by appropriate push-buton “RESTORE”.

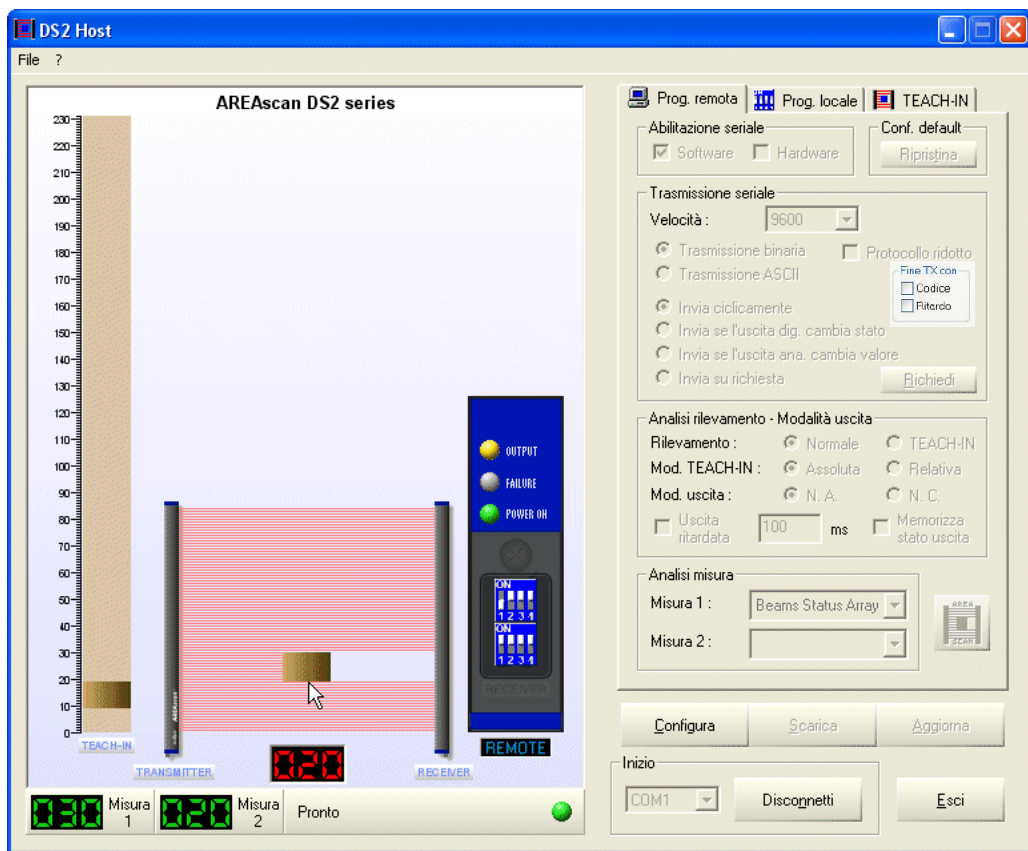

Fig. 11 - DS2 Graphic user interface

### **6.2.1. DS2 user interface – General information**

The DS2 user interface is a Windows program, compatible with 9x/SE/Me/NT/2000/XP versions, that controls the scanning trend and the digital output status of the DS2 **AREAscan**<sup>TM</sup> light grids.

Thanks to the easy and intuitive user interface, the different configuration parameters of the light grid, stored in the non-volatile device memory, can be visualised and modified.

*The number and type of measurements transmitted depend on the local or remote programming.*

*In local programming, a fixed measurement is transmitted for each operating mode.*

*Whereas in remote programming, one or more measurements can be selected amongst those listed in section 5.2 "Measurement mode".*

*Please acknowledge that the same measurements cannot be selected twice.*

*This data can be transmitted either in binary or in ASCII code.*

The communication protocol can be developed according to the Master Slave mode.

The information exchange can be made in the *request-reply* mode: the master sends a data packet to the slave and the slave replies sending another data packet to the master.

The communication line is a *half duplex* (RS485) type and can be used by only one unit a time.

The master always begins the exchange.

### **6.2.2. Program installation**

Insert the CD of the DS2 Host Interface software in the PC reader.

The installation program will begin automatically. Simply follow the indications provided.

6.2.3. *Graphic user interface*

The following window will be visualised at program initialisation:

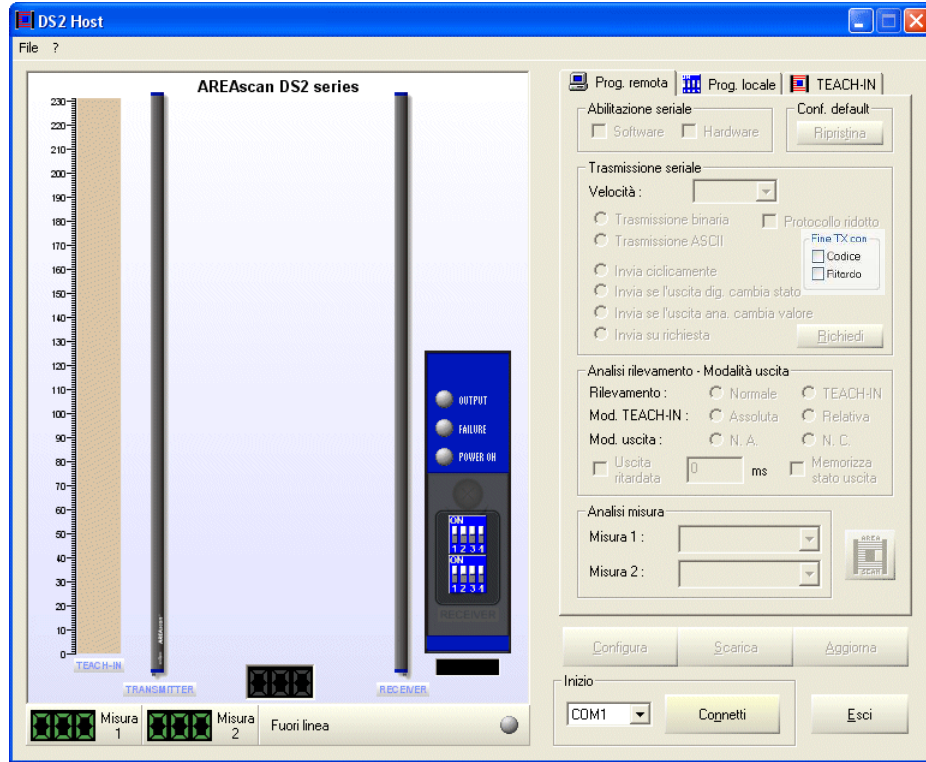

Fig. 12

Two important areas are distinguished: the data control area on the left (graph representing light grid with scanning area, Teach-in status indicated on a measurement bar, a panel with luminous indicators and dip-switch status, various digital indicators for measurement visualisation and a communication status bar). The function selection area is on the right side.

6.2.4. *Connection with AREAscan™ DS2 series*

As mentioned, the DS2 light grid has a RS485 serial communication line (half duplex). As far as the PC is concerned, a RS232/RS485 serial adapter is necessary in order to communicate with the light grid receiver. The program controls the receipt/transmission on the RS485 line using the RTS line present on the RS232 connector. The adapter has to support this characteristic.

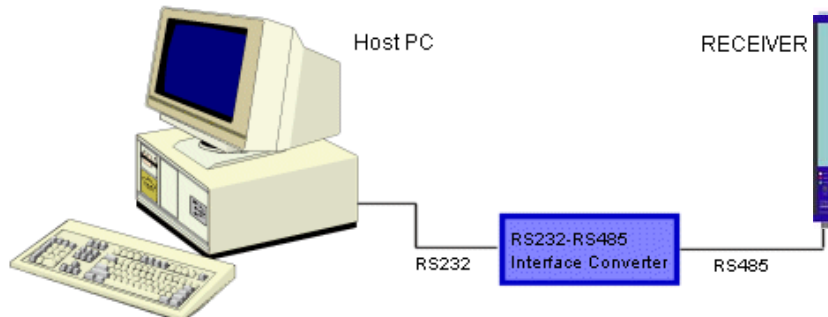
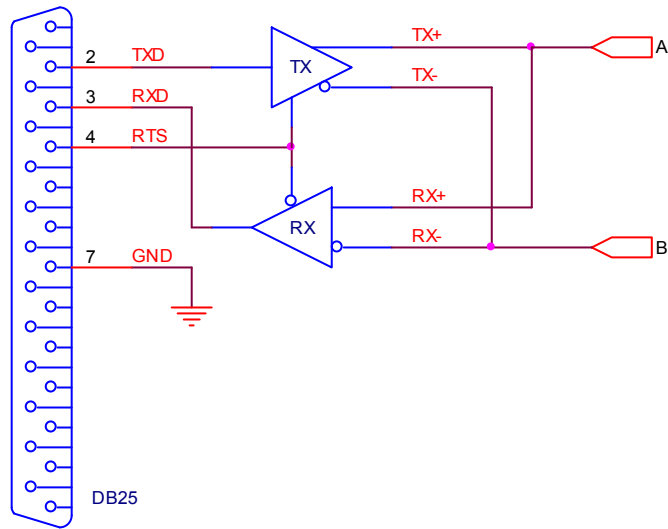

Fig. 13

The following figures show the typical diagram of a RS232/RS485 converter.



| Host PC (DB9) | Converter (RS232-DB25 side) |
|---------------|-----------------------------|
| TXD (3)       | TXD (2)                     |
| RXD (2)       | RXD (3)                     |
| RTS (7)       | RTS (4)                     |
| GND (5)       | GND (7)                     |

| Converter (RS485 side) | DS2    |
|------------------------|--------|
| A                      | D+ (6) |
| B                      | D- (1) |

| Host PC (DB25) | Converter (RS232-DB25 side) |
|----------------|-----------------------------|
| TXD (2)        | TXD (2)                     |
| RXD (3)        | RXD (3)                     |
| RTS (4)        | RTS (4)                     |
| GND (7)        | GND (7)                     |

| Converter (RS485 side) | DS2    |
|------------------------|--------|
| A                      | D+ (6) |
| B                      | D- (1) |

The program is ready to function after connecting the PC to the RS485 serial line and powering the DS2. Select the COM1, COM2, COM3 or COM4 serial communication port and press *Connect*. A small window visualises a “*Wait please...*” message. The program will effect scanning on the serial line testing separately each transmission speed until reaching the set DS2 speed (please consider that this operation requires a few seconds). Once connected, the program will memorize the transmission speed reached on the disk in order to optimise successive connections. This will reduce the connection time, eliminating the initial scanning testing time.

The following window will appear if the connection fails:

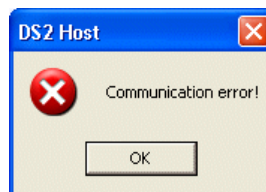

In this case check the electrical connection and device powering.



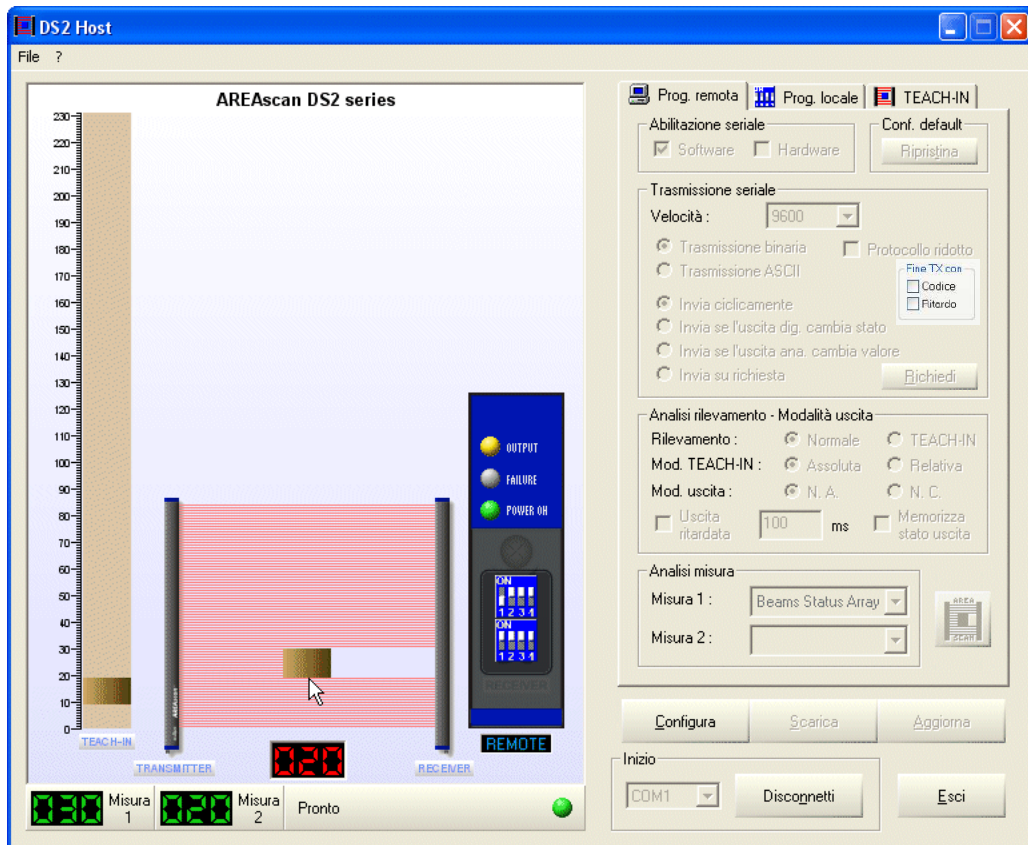

Fig.14

After connection (see previous figure) and according to the local or remote programming, the graphic on the left side of the user interface's main window will visualise the following:

- the beams and object shape
- the Teach-in memorised in the receiver unit
- the indicators of the two measurements according to the programming mode selected
- local and remote configuration status

The bars that represent the light grid are automatically re-sized according the DS2 model connected. The *Configure* button is activated and the *Connect* button becomes *Disconnect*.

Passing the cursor over the scanning area, the digital indicator below lights up showing the position of the beam selected. The same happens in the Teach-in bar.

The current programming mode selected is visualised under the virtual panel. The programming mode can be changed only using the dip-switch located on the DS2 light grid, also during device powering. The dip-switch, corresponding to the programming mode, is the only one decoded in real time. All the other switches require device turning off and re-powering. Misalignments can thus occur between the real dip-switches and the virtual ones of the interface.

Figure 20 shows the windows on the right side of the interface, which is initially deactivated:

- **Remote prog.:** this page visualises the different parameter settings and thus allows their modification in the remote mode.
- **Local prog.:** visualises only the status of the dip-switches present on DS2.
- **Teach-in:** edits the object shape using the Teach-in mode.

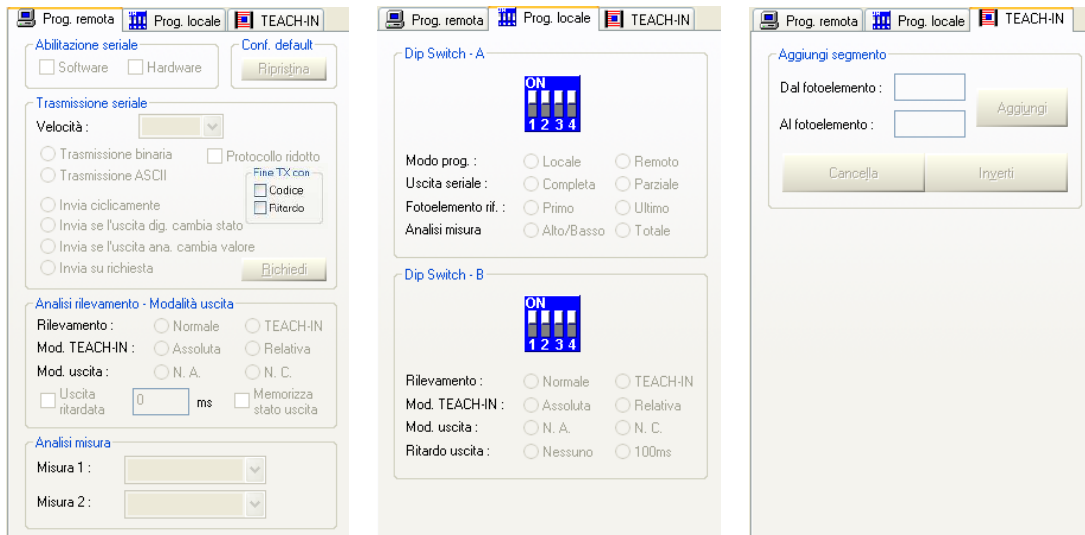

Fig. 15

### 6.2.5. Configuration of the AREAscan™ DS2 series

The configuration session can be accessed selecting the *Configure* button.

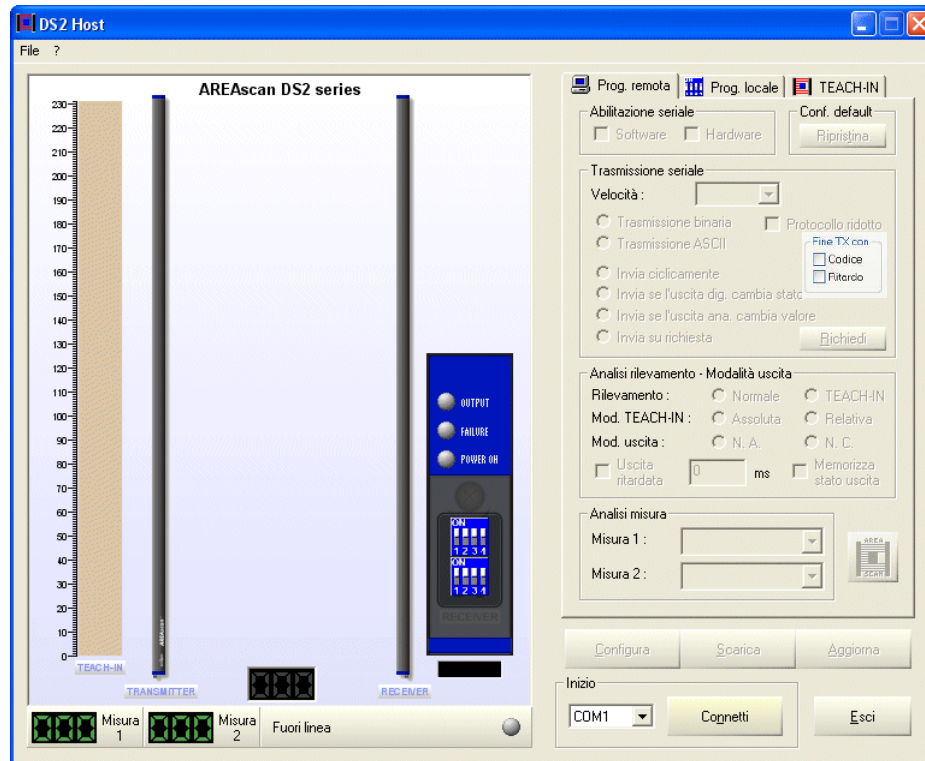

Fig. 16

The access in the configuration mode suspends the scanning during the entire session. A small window visualises a “*Wait please...*” message.

If the command is accepted, the *Configure* button changes and becomes *End*, and the *Download* and *Update* buttons are activated. The data entry fields and the selection buttons are also active.

Three different sections are distinguished in the *Remote prog.* page:

- *Serial transmission*: allows to set the transmission baud-rate, type of data (binary or ASCII) to send periodically at the end of each scanning in case of digital output switching or user request. In the latter, the *Request* button becomes active if the DS is functioning in remote mode, when exiting from the configuration session. The serial transmission can be completely deactivated. It remains active only for communication with host.  
*Short Protocol* is a data transmission mode very simple and it is used for one measure only “Restore” push-button recall default factory configuration.

**Remote configuration from host user interface:** synoptic table showing the output variation with respect to the serial output configuration

| <i>Function</i>                   | <i>Mode</i>                   |                            | <i>Outputs</i> |           |  |
|-----------------------------------|-------------------------------|----------------------------|----------------|-----------|--|
|                                   |                               |                            | Analog         | Switching | Serial   |
| Serial Communication Enable       | SW                            | Enable                     | -              | -         | Comm. Enable   |
|                                   |                               | Disable                    | -              | -         | Comm. Disable  |
|                                   | HW                            | pin5 RX connector on 24Vdc | -              | -         | Comm. Enable   |
|                                   |                               | pin5 RX connector floating | -              | -         | Comm. Disable  |
| Serial Transmission Type          | ASCII                         |                            | -              | -         | Type ASCII   |
|                                   | Binary                        |                            | -              | -         | Type Binary  |
| Baud Rate                         | 9600                          |                            | -              | -         | -  |
|                                   | 19200                         |                            | -              | -         | -  |
|                                   | 38400                         |                            | -              | -         | -  |
|                                   | 57600                         |                            | -              | -         | -  |
| Data Sending Type                 | Cyclical                      |                            | -              | -         | Send every cycle   |
|                                   | Output changes state          |                            | -              | -         | Send when PNP/NPN output changes state   |
|                                   | Analogue output changes state |                            | -              | -         | Send when Analogue output changes state  |
|                                   | On request                    |                            | -              | -         | Send by host request   |
| Short Protocol                    | Binary only                   |                            | -              | -         | Send with short protocol   |
| End of Serial Packet Transmission | Not selected                  |                            | -              | -         | -  |
|                                   | Code                          |                            |                |           | the serial transmission is finished by a fixed sequence of 4-ASCII characters "@EOP"                             |
|                                   | Delay                         |                            |                |           | the serial transmission is delayed by a equivalent time of 40 characters transmissions at the Baud Rate selected |

- *Short Protocol* enables the transmission of one single char in binary code related to one single measure. This protocol is available in remote configuration mode only, binary transmission.
- *Detection analysis and output mode:* allows to set the object detection mode (normal or Teach-in), the normally open or normally closed switching output and any delay after detection. In the latter a delay time ranging from 0 to 200 milliseconds can be selected.
- *End of serial packet transmission:*
  - selecting "Code", the serial transmission is finished by a fixed sequence of 4-ASCII characters "@EOP".
  - selecting "Delay", the serial transmission is delayed by a equivalent time of 40 characters transmissions at the Baud Rate selected.

**Remote configuration from host user interface:** synoptic table showing the output variation with respect to the detection analysis mode configuration

| <i>Function</i>        |               | <i>Mode</i>                           | <i>Outputs</i>   |   |  |
|------------------------|---------------|---------------------------------------|--|---|--|
|                        |               |                                       | Analog   | Switching   | Serial   |
| Normal                 |               |                                       | -  | Presence detection                                | -  |
|                        | TEACH-IN      | Get TEACH-IN from DS2                 | -  | Conditional presence detection from TEACH-IN      | -  |
|                        |               | Set TEACH-IN from User Interface      |  | Conditional presence detection from TEACH-IN      |  |
|                        | TEACH-IN Mode | Absolute Positioning Detection        | -  | Positional detection of TEACH-IN ref. object      | -  |
|                        |               | Relative Positioning Detection        |  | Detection of TEACH-IN reference object            |  |
| Switching Output Mode  |               | Normally Opened                       | -  | Current on switching device during detection      | -  |
|                        |               | Normally Closed                       | -  | No current on switching device during detection   | -  |
| Switching Output Delay |               | No Delay                              | -  | -   | -  |
|                        |               | $0 < T_{\text{DELAY}} < 200\text{ms}$ | -  | Restore from detection delay = $T_{\text{DELAY}}$ | -  |
| Output Hold            |               | Enable                                | It holds analogue and serial output to the higher detected value during enable of "output HOLD" input (pin5 RX connector on 24Vdc) | -   | It holds analogue and serial output to the higher detected value during enable of "output HOLD" input (pin5 RX connector on 24Vdc) |
|                        |               | Disable                               | Normal operation   |   |  |

The local teach-in mode can be emulated through serial interface selecting a group of contiguous beams. Select the first and last photoelements of the segment that have to be added and then press *Add*. The shape is immediately drawn in the Teach-in bar (see Fig.17). This operation can be repeated to set different objects with the most varied shapes. The entire shape can be changed or inverted selecting repetitively the *Cancel* and *Invert* buttons. The object presence is characterised by a dark colour and the object absence by a light colour.

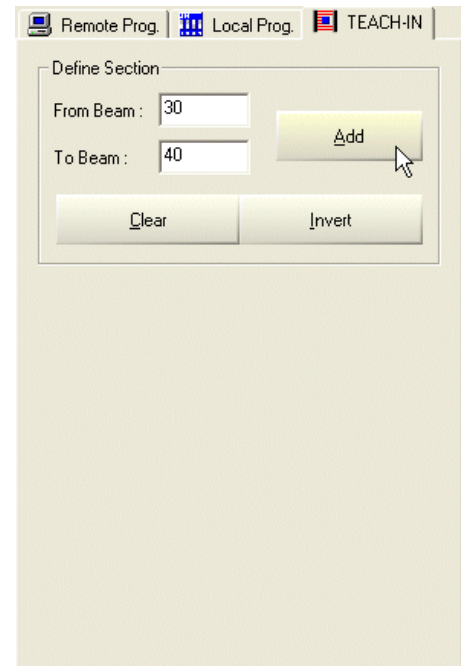
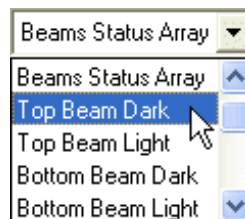

Fig. 17

- *Measurement analysis*: maximum two measurement transmissions can be set in the remote mode according to the *Serial transmission* section.



Different options are available:

- None
- Beam Status Array
- Top Beam (dark or light)
- Bottom Beam (dark or light)
- Middle Beam (dark or light)
- Total Beam (dark or light)
- Total Contiguous Beam (dark or light)
- Transition number (dark or light)

**Remote configuration from host user interface:** synoptic table showing the output variation with respect to the detection analysis mode configuration

| Function                   |                        | Mode   | Outputs                       |                               |                 |
|----------------------------|------------------------|--|-------------------------------|-------------------------------|-----------------|
|                            |                        |  | Analogue                      | Switching                     | Serial          |
| Complete Beam Status Array |                        |  | $V=V_{RES} * N_{BEAM}$ [dark] |                               | ASCII           |
|                            |                        |  |                               |                               | Binary          |
| Top Beam                   | Dark (default)         | $V=V_{RES} * N_{BEAM}$ [Top; reference]                          |                               | Top Beam                      | ASCII<br>Binary |
|                            | Light                  | $V=V_{RES} * N_{BEAM}$ [Top light; reference]                    |                               | Top Beam (light)              | ASCII<br>Binary |
| Bottom Beam                | Dark (default)         | $V=V_{RES} * N_{BEAM}$ [Bottom; reference]                       |                               | Bottom Beam                   | ASCII<br>Binary |
|                            | Light                  | $V=V_{RES} * N_{BEAM}$ [Bottom light; reference]                 |                               | Bottom Beam (light)           | ASCII<br>Binary |
| Middle Beam                | Dark (default)         | $V=V_{RES} * N_{BEAM}$ [0.5*(Top-Bottom); reference]             |                               | Middle Beam                   | ASCII<br>Binary |
|                            | Light                  | $V=V_{RES} * N_{BEAM}$ [0.5*(Top light-Bottom light); reference] |                               | Middle Beam (light)           | ASCII<br>Binary |
| Total Beam                 | Dark (default)         | $V=V_{RES} * N_{BEAM}$ [dark]                                    |                               | Total Beam                    | ASCII<br>Binary |
|                            | Light                  | $V=V_{RES} * N_{BEAM}$ [dark]                                    |                               | Total Beam (light)            | ASCII<br>Binary |
| Total Contiguous Beam      | Dark (default)         | $V=V_{RES} * N_{BEAM}$ [dark]                                    |                               | Total Contiguous Beam         | ASCII<br>Binary |
|                            | Light                  | $V=V_{RES} * N_{BEAM}$ [dark]                                    |                               | Total Contiguous Beam (light) | ASCII<br>Binary |
| Total Beam                 | Light → Dark (default) | $V=V_{RES} * N_{BEAM}$ [dark]                                    |                               | N. Transitions Light → Dark   | ASCII<br>Binary |
|                            | Dark → Light           | $V=V_{RES} * N_{BEAM}$ [dark]                                    |                               | N. Transitions Dark → Light   | ASCII<br>Binary |

Some sections exclude each other (one or the other), i.e. if the *Beam Status Array* has been chosen as measurement 1, all the items of measurement 2 are deactivated. Another example: if *Top Beam Dark* has been chosen as the first measurement, the operator can choose any other measurement excluding the same type as the first and *Beams Status Array*. The items not admitted become grey.

The settings will be memorised in the DS2 non-volatile memory pressing the *Update* button.

The graphic will be restored with the last shape stored in the DS2 memory by selecting the *Download* button.

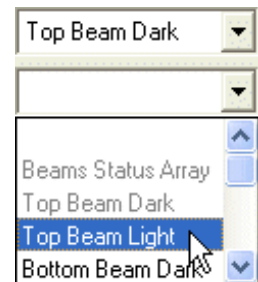

Press *End* to quit configuration session. The system will request the exit confirmation.

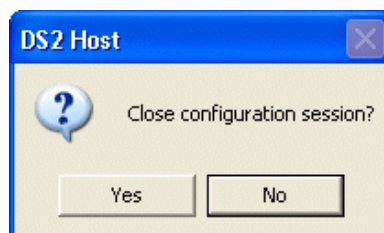



The following windows can appear successively:

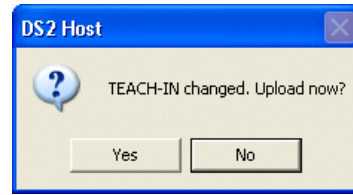
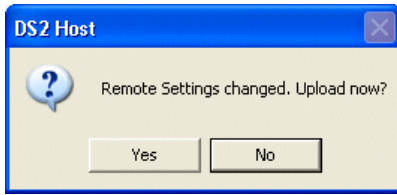

If one or both windows appear, some data have been changed or the operator has forgotten to update DS2 with the changes. Press Yes to confirm, or No to ignore changes.

Lastly, depending on the options selected, a window like this could appear:

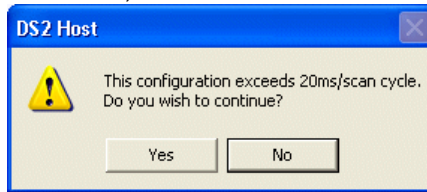

This window warns the operator that the scanning time exceeds the value set in milliseconds per cycle.

**6.2.6. File saving of the configuration options**

The current device configuration can be memorised during the configuration session. Select *File* and then *Save*. The system will request the operator to assign a name to the file with the configuration options.

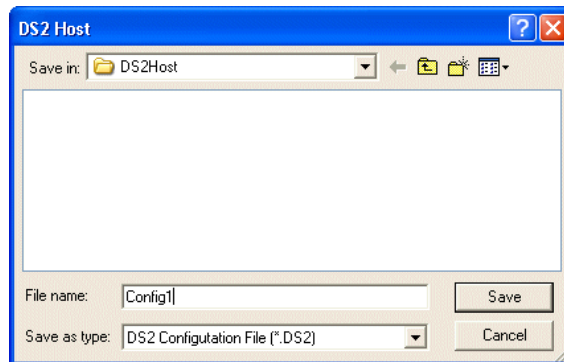
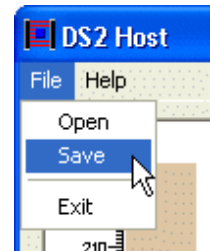

**6.2.7. File loading of the configuration options**

A previously stored device configuration can be loaded from file during the configuration session. Select *File* and then *Open*. Select the desired file.

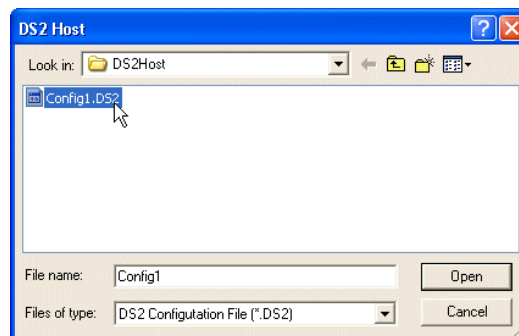

The *Remote prog.* page and the *Teach-in* bar are updated with the values contained in the file. To update the DS2 memory, press *Update*.



## 7. AREAscan™ DS2 SERIES – COMMUNICATION PROTOCOL

### 7.1. Packet description

As mentioned, the communication protocol requires a *master* unit and a *slave* unit. The communication type is *half duplex* (RS485).

The exchange of information is made in the *request-reply mode*: the master sends a data packet to the slave that replies sending another data packet to the master.

#### 7.1.1 Binary data packet structure

A binary data packet is composed of a group of bytes placed in a well-defined sequence, that identifies it univocally. It presents a *heading*, *body* and an *end*.

The heading and the end have a fixed length while the body has a variable length.

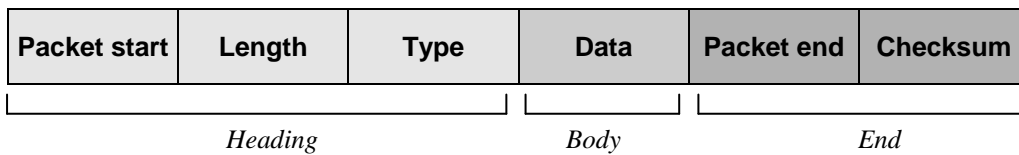

- Packet beginning: 1 byte, STX ASCII code ('0x02')
- Length: 1 byte, length in bytes of the *Type* field plus the *Data* field
- Type: 1 byte, code identifying the packet type ('A', 'B', 'C' ASCII code, etc.)
- Data: variable number of bytes (from 0 to 254) that form the packet information
- Packet end: 1 byte, ETX ASCII code('0x03')
- Checksum: 1 byte, complement to one of the *Length*, *Type* and *Data* field bytes sum.

#### 7.1.2. Short protocol binary data packet structure

There is a binary data packet with reduced protocol composed by one byte. This format is reserved to trasmission of numeric type value only (for example one measure).

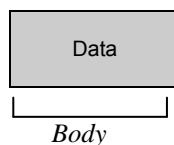

Data: 1 byte with binary data packet

#### 7.1.3. ASCII data packet structure

An ASCII data packet is composed of:

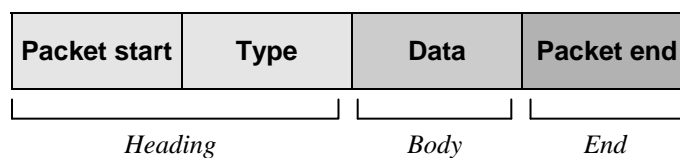

- Packet beginning: 1 byte, '\*' ASCII code (0x2A)
- Type: 1 byte, code identifying the packet type ('A', 'B', 'C' ASCII code, etc.)
- Data: variable number of '0'-'9' 'A'-'Z' ASCII codes (from 0 to 254) that form the packet information
- Packet end: 1 byte, CR ASCII code (0x0D)

**7.2 Operating mode: DS2 (master) → Host Interface (slave)**

At powering the DS2 becomes the *master* and transmits periodically, as previously explained, a packet at each scanning of the measurement information according to the configuration. The host, which is the *slave*, receives the packet and elaborates the data. This is the only case where a response packet is not necessary.

**7.2.1. Packet description**

**a. Complete binary scanning result (Complete beam status array) - 0x41 ('A' ASCII)**

Sends to host the pattern with the binary information relative to each beam.

DS2 sends:

|      |   |             |                         |      |   |
|------|---|-------------|-------------------------|------|---|
| 0x02 | n | <b>0x41</b> | aaa bbb ccc ..... zzz s | 0x03 | x |
|------|---|-------------|-------------------------|------|---|

where:

n = 0x0E (600 mm model), 0x14 (900 mm model), 0x1A (1200 mm model), 0x23 (1650 mm model)

aaa = 3 bytes with information concerning the 01-21 photoelements

bbb = 3 bytes with information concerning the 22-42 photoelements

ccc = 3 bytes with information concerning the 42-63 photoelements

zzz = 3 bytes with information concerning the last 21 photoelements

s = 1 byte indicating scanning status:

bit 0 = Power LED (0 OFF, 1 ON)

bit 1 = Failure LED (0 OFF, 1 ON)

bit 2 = Output LED (0 OFF, 1 ON)

bit 3 = PNP/NPN output (0 deactivated, 1 active)

bit 4 = Short-circuit output (0 no, 1 yes)

bit 5 = Misaligned photoelements or stability (0 no, 1 si)

bit 6 = N/A.

bit 7 = Programming mode (0 local, 1 remote)

x = checksum (complement to one of the *Length*, *Type* and *Data* field bytes sum)

Example:

Supposing to have the following data range:

0x01 0x02 0x03 0x04 0x05 0x06

the length will be 0x07 (one byte of the *Type* field plus six bytes of the *Data* field).

If the packet is a 0x41 type ('A' ASCII), then the checksum will be:

$$\text{checksum} = (0x07 + 0x41 + 0x01 + 0x02 + 0x03 + 0x04 + 0x05 + 0x06) \text{ XOR } 0xFF = \mathbf{0xA2}$$

The correspondence between the photoelements (21) and the bits of a bytes tern is given below:

|              |    |    |    |    |    |    |    |    |    |    |    |    |    |    |    |    |    |    |    |    |    |    |    |    |
|--------------|----|----|----|----|----|----|----|----|----|----|----|----|----|----|----|----|----|----|----|----|----|----|----|----|
| Photoelement | 21 | 20 | 19 | 18 | 17 | 16 | 15 | 14 | 13 | 12 | 11 | 10 | 09 | 08 | 07 | 06 | 05 | 04 | 03 | 02 | 01 |    |    |    |
| Bytes tern   | D7 | D6 | D5 | D4 | D3 | D2 | D1 | D0 | D7 | D6 | D5 | D4 | D3 | D2 | D1 | D0 | D7 | D6 | D5 | D4 | D3 | D2 | D1 | D0 |

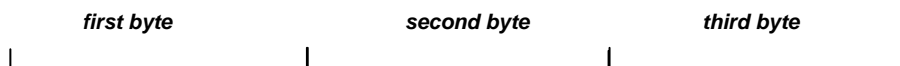

The position of one beam can be identified by the weight of the single bits, and the status from its value from zero or one.

A bit at zero, indicates a non-obscured beam, and a bit at one indicates an obscured beam.

**b. Complete ASCII scanning result (Complete beam status array) - 0x41 ('A' ASCII)**  
 Sends to host the pattern with the ASCII information relative to each beam.

DS2 sends:

|      |             |                                      |      |
|------|-------------|--------------------------------------|------|
| 0x2A | <b>0x41</b> | aaaaaa bbbbbb cccccc ..... zzzzzz ss | 0x0D |
|------|-------------|--------------------------------------|------|

where:

- aaaaaa = 6 ASCII codes (3 bytes) with information concerning the 01-21 photoelements
- bbbbbb = 6 ASCII codes (3 bytes) with information concerning the 22-42 photoelements
- ccccc = 6 ASCII codes (3 bytes) with information concerning the 42-63 photoelements
- zzzzz = 6 ASCII codes (3 bytes) with information concerning the last 21 photoelements
- ss = 2 ASCII codes (1 byte) indicating scanning status (see above)

**c. Partial Binary scanning result (Measurements) - 0x42 ('B' ASCII)**

Sends to host one or due numeric measurements.

DS2 sends (only one measurement):

|      |      |             |       |      |   |
|------|------|-------------|-------|------|---|
| 0x02 | 0x04 | <b>0x42</b> | m a s | 0x03 | x |
|------|------|-------------|-------|------|---|

where:

- m = ASCII char linked to kind of measure (ASCII code linked to kind of measure get as sum of char "A" and numeric value of kind of measure ①).
- a = 1 byte with the (0 – 231)
- x = checksum (complement to one of the *Length, Type* and *Data* field bytes sum)
- s = 1 byte with scan state:
  - bit 0 = Power Led (0 OFF, 1 ON)
  - bit 1 = Failure Led (0 OFF, 1 ON)
  - bit 2 = Output Led (0 OFF, 1 ON)
  - bit 3 = Uscita PNP/NPN (0 disable, 1 enable)
  - bit 4 = short-circuit switching output (0 none, 1 yes)
  - bit 5 = stability (0 none, 1 yes)
  - bit 6 = n. a.
  - bit 7 = Programming Mode (0 local, 1 remote)

DS2 sends (two measurements):

|      |      |             |           |      |   |
|------|------|-------------|-----------|------|---|
| 0x02 | 0x06 | <b>0x42</b> | m a n b s | 0x03 | x |
|------|------|-------------|-----------|------|---|

where:

- m = ASCII char linked to kind of measure (ASCII code linked to kind of measure get as sum of char "A" and numeric value of kind of measure ①).
- a = 1 byte with #1 measurement (0 – 231)
- n = 1 ASCII code with #2 measurement ('A' + numerical value of the measurement type)
- b = 1 byte with #2 measurement (0 – 231)
- x = checksum (complement to one of the *Length, Type* and *Data* field bytes sum)
- s = 1 byte with scan state:
  - bit 0 = Power Led (0 OFF, 1 ON)
  - bit 1 = Failure Led (0 OFF, 1 ON)
  - bit 2 = Output Led (0 OFF, 1 ON)
  - bit 3 = Uscita PNP/NPN (0 disable, 1 enable)
  - bit 4 = short-circuit switching output (0 none, 1 yes)
  - bit 5 = stability (0 none, 1 yes)
  - bit 6 = n. a.
  - bit 7 = Programming Mode (0 local, 1 remote)

**d. Partial Binary scanning result (Measurements) – Short protocol**

Send to host one measure only with reduced binary format (one byte).

DS2 sends (one measurement only):

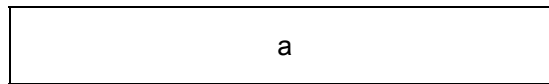

where:

a = 1 byte with measure (0 – 231)

**e. Partial ASCII scanning result (Measurements) - 0x42 ('B' ASCII)**

Sends to host one or due numeric measurements in ASCII (see above).

DS2 sends (one measurement):

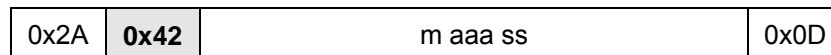

dove:

m = ASCII char linked to kind of measure (ASCII code linked to kind of measure get as sum of char "A" and numeric value of kind of measure ①).

aaa = 3 ASCII codes with measurement ("000" – "231")

ss = 2 ASCII char (1 byte) with scan state:

- bit 0 = Power Led (0 OFF, 1 ON)
- bit 1 = Failure Led (0 OFF, 1 ON)
- bit 2 = Output Led (0 OFF, 1 ON)
- bit 3 = Uscita PNP/NPN (0 disable, 1 enable)
- bit 4 = short-circuit switching output (0 none, 1 yes)
- bit 5 = stability (0 none, 1 yes)
- bit 6 = n. a.
- bit 7 = Programming Mode (0 local, 1 remote)

DS2 sends (two measurements):

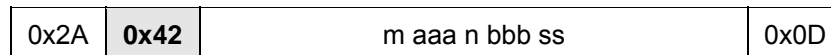

where:

m = ASCII char linked to kind of measure (ASCII code linked to kind of measure get as sum of char "A" and numeric value of kind of measure ①).

aaa = 3 ASCII codes with #1 measurement ("000" – "231")

n = 1 ASCII code with #2 measurement ('A' + numerical value of the measurement type)

bbb = 3 ASCII codes with #2 measurement ("000" – "231")

ss = 2 ASCII char (1 byte) with scan state:

- bit 0 = Power Led (0 OFF, 1 ON)
- bit 1 = Failure Led (0 OFF, 1 ON)
- bit 2 = Output Led (0 OFF, 1 ON)
- bit 3 = Uscita PNP/NPN (0 disable, 1 enable)
- bit 4 = short-circuit switching output (0 none, 1 yes)
- bit 5 = stability (0 none, 1 yes)
- bit 6 = n. a.
- bit 7 = Programming Mode (0 local, 1 remote)

---

① ASCII code linked to kind of measure get as sum of char "A" and numeric value of kind of measure.

'A' = Measure disabled (n. a.)

'F' = Bottom beam light

'K' = Total contiguous beam dark

'B' = Complete beams status array (n. a.)

'G' = Middle beam dark

'L' = Total contiguous beam light

'C' = Top beam dark

'H' = Middle beam light

'M' = N. of transitions dark

'D' = Top beam light

'I' = Total beam dark

'N' = N. of transitions light

'E' = Bottom beam dark

'J' = Total beam light

### 7.3. Configuration mode: DS2 (slave) ← Host (master)

#### 7.3.1 Host appropriation procedure of the bus

To access the configuration mode, the DS2 has to receive a special command that momentary suspends scanning and the control is passed to the host. The host thus becomes the *master* and the DS2 the *slave*. All the outputs are deactivated.

The device remains in this mode until it receives the configuration quit command.

The host controls the bus and becomes the master sending a particular string denominated **synchronism code (ASCII SYN '0x16')**.

The DS2 light grid is normally the master and is set to discharge control only after the following conditions:

Between one scanning and the other, the DS2 is in the receiving mode for a short period (few milliseconds). To discard the control, the DS2 has to receive, 3 synchronism codes within 2.5 seconds from the receipt of the first code, the device will then suspend the data transmission and leaves a larger receiving window open (about 250 milliseconds) where the host can send the command.

If the command is not decoded or exceeds the time available, the DS2 will re-assume the line control and the operation has to be repeated. This technique has to be used before sending any command if the DS2 light grid is the master. **The transmission of the synchronism codes is not necessary if DS2 is already the slave.**

The following figure represents an example of data exchange on the serial communication line using the SYNCHRONISM command.

The transmitted packets are highlighted in black (TXD) by the DS2 at the end of each scanning. When effecting a command, the host begins to send the SYN codes (0x16) in the temporal windows left between the two consecutive scanings (see points 1, 4 and 5). If the host transmits contemporarily the SYN codes to the DS2, the SYN codes will be lost (see points 2 and 3).

The codes have to be continuously sent until the DS2 ends the packet transmission (see point 6).

The Host can now include the 0x43 synchronism command and the DS2 replies with the respond packet (see point 7 and 8). The DS2 effects the scanning immediately after (see point 9).

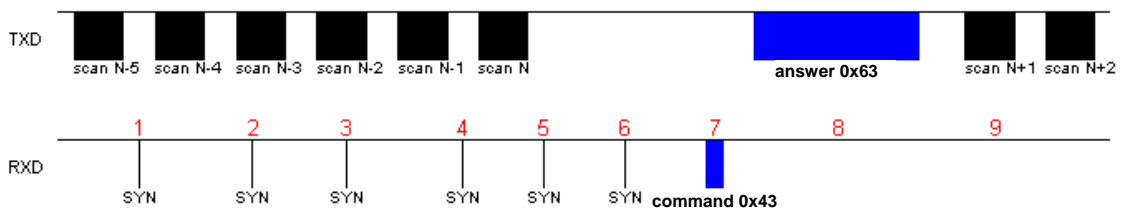

### 7.3.2 Command packet description:

#### a. Synchronism command - 0x43 ('C' ASCII)

The host can use this command when connected to DS2 to obtain the local/remote configuration parameters. If the serial transmission speed is missing, all known baud-rates can be tested until the connection is established.

Host sends:

|      |      |             |      |      |
|------|------|-------------|------|------|
| 0x02 | 0x01 | <b>0x43</b> | 0x03 | 0xBB |
|------|------|-------------|------|------|

DS2 replies:

|      |      |             |             |      |   |
|------|------|-------------|-------------|------|---|
| 0x02 | 0x0A | <b>0x63</b> | n   rrrrrrr | 0x03 | x |
|------|------|-------------|-------------|------|---|

N = 1 byte with photoelement number (84, 126, 168 or 231)

L = 1 byte with the local configuration status (Dip-switch)

|                   |   |
|-------------------|---|
| bit 0 = OutDelay  | 4B - Output Delay (No Delay/100ms Delay)      |
| bit 1 = OutMode   | 3B - Output Mode (NO/NC)                      |
| bit 2 = TeachMode | 2B - Teach-in Mode (Absolute/Relative)        |
| bit 3 = TeachAcc  | 1B - Teach-in active (Inactive/Active)        |
| bit 4 = MeasAna   | 4A - Measurement Analysis Mode (BotTop/Total) |
| bit 5 = MeasRef   | 3A - Measurement Reference Beam (Bottom/Top)  |
| bit 6 = SerMode   | 2A - Serial Output Mode (Binary/ASCII)        |
| bit 7 = ProgMode  | 1A - Programming Mode (Local/Remote)          |

rrrrrr = 7 bytes with the remote configuration status

|                      |   |
|----------------------|---|
| byte 1 = SerComm     | Serial Communication (1 = Active, 0 = Inactive)<br>Short Protocol (bit 7 = 1 ⇒ Enable, bit 7 = 0 ⇒ Disable) |
| byte 2 = BaudRate    | Baud-rate (range 0 = 9600, 1 = 19200, 3 = 38400 4 = 57600)  |
| byte 3 = MeasAna1    | Measurement Analysis Mode 1 (see below) ②   |
| byte 4 = MeasAna2    | Measurement Analysis Mode 1 (see below) ②   |
| byte 5 = SendType    | Data Sending Type (0 = Cyclical, 1 = On Change or 2 = On Request)   |
| byte 6 = DipSw       | Remote setting by virtual dip-switches (only partially applicable) ③  |
| byte 7 = OutputDelay | Output Delay 0-200ms  |

x = checksum (complement to one of the *Length*, *Type* and *Data* field bytes sum)

#### ② Numeric value associated to measurement type:

|    |                               |
|----|-------------------------------|
| 0  | = Measure disabled            |
| 1  | = Complete beams status array |
| 2  | = Top beam dark               |
| 3  | = Top beam light              |
| 4  | = Bottom beam dark            |
| 5  | = Bottom beam light           |
| 6  | = Middle beam dark            |
| 7  | = Middle beam light           |
| 8  | = Total beam dark             |
| 9  | = Total beam light            |
| 10 | = Total contiguous beam dark  |
| 11 | = Total contiguous beam light |
| 12 | = N. of transitions dark      |
| 13 | = N. of transitions light     |

#### ③ Remote configuration state (Virtual Dip Switch)

|       |             |  |
|-------|-------------|--|
| bit 0 | = OutDelay  | 4B - Output Delay (No Delay/Delay)     |
| bit 1 | = OutMode   | 3B - Output Mode (NO/NC)               |
| bit 2 | = TeachMode | 2B - Teach-In Mode (Absolute/Relative) |
| bit 3 | = TeachEna  | 1B - Teach-In Enable (Disable/Enable)  |
| bit 4 | = MeasAna   | 4A - n. a.                             |
| bit 5 | = MeasRef   | 3A - n. a.                             |
| bit 6 | = SerMode   | 2A - Serial Output Mode (Binary/ASCII) |
| bit 7 | = ProgMode  | 1A - n. a.                             |

**b. Scanning suspension command - 0x44 ('D' ASCII)**

Momentary suspends the scanning and passes the control to the host.

Host sends:

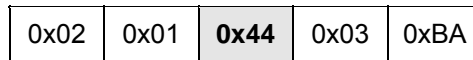

DS2 responds:

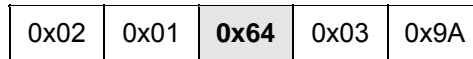

The following figure is similar to the previous one with the difference that the scanning now does not re-start automatically after receiving the command (see point 9).

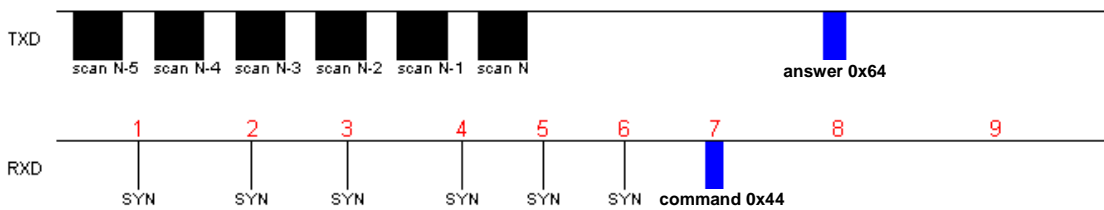

**c. Scanning re-start command - 0x45 (ASCII 'E' )**

Informs DS2 to re-start the normal scanning mode and the host loses the line control.

Host sends:

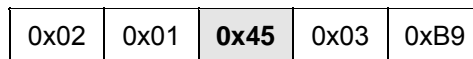

DS2 replies:

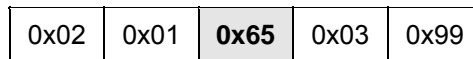

In this case the SYN codes do not have to be sent as the scanning is suspended. The command is accepted immediately. After the exchange of the packets (see points 1 and 2), DS2 re-starts the scanning (see point 3).

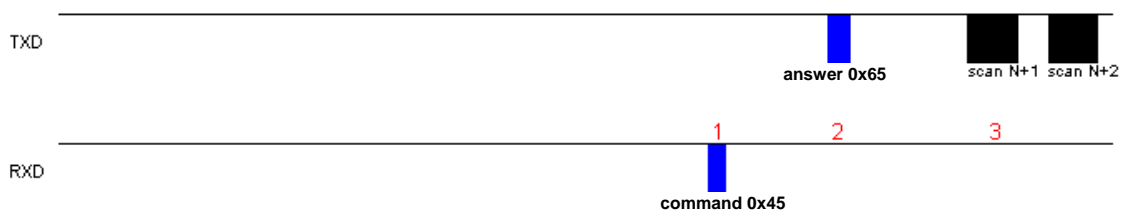

**d. Scanning command on request (Data sending on request) - 0x46 (ASCII 'F')**

When DS2 is programmed in Remote Mode – Data Sending On Request, the host sends this special command to request the information packet relative to each single beam or partial scanning information in the form of one or two numeric measurements of the following type:

- Top Beam (dark or light)
- Bottom Beam (dark or light)
- Middle Beam (dark or light)
- Total Beam (dark or light)
- Total Contiguous Beam (dark or light)
- Transition number (dark or light)

Host sends:

|      |             |
|------|-------------|
| 0x1B | <b>0x46</b> |
|------|-------------|

DS2 replies:

The DS2 replies with one of the following packets according to the selected programming mode:

- Complete Binary Scanning (Beam Status Array) - 0x41 ('A' ASCII)
- Complete ASCII Scanning (Beam Status Array) - 0x41 ('A' ASCII)
- Partial Binary Scanning (Measurements) - 0x42 ('B' ASCII)
- Partial ASCII Scanning (Measurements) - 0x42 ('B' ASCII)

For the description of these packets, see section “*Scanning modes*”.

**e. Remote configuration reading command - 0x47 ('G' ASCII)**

Reads the binary information relative to the remote configuration.

Host sends:

|      |      |             |      |      |
|------|------|-------------|------|------|
| 0x02 | 0x01 | <b>0x47</b> | 0x03 | 0xB7 |
|------|------|-------------|------|------|

DS2 replies:

|      |      |             |         |      |   |
|------|------|-------------|---------|------|---|
| 0x02 | 0x08 | <b>0x67</b> | rrrrrrr | 0x03 | x |
|------|------|-------------|---------|------|---|

where:

rrrrrrr = 7 bytes with the remote configuration status (see *Synchronism* packet)

x = checksum (complement to one of the *Length*, *Type* and *Data* field bytes sum)



**f Remote configuration writing - 0x48 ('H' ASCII)**

Saves in the DS2 non-volatile memory the binary information of the remote configuration.

Host sends:

|      |      |             |         |      |   |
|------|------|-------------|---------|------|---|
| 0x02 | 0x08 | <b>0x48</b> | rrrrrrr | 0x03 | x |
|------|------|-------------|---------|------|---|

DS2 replies:

|      |      |             |      |      |
|------|------|-------------|------|------|
| 0x02 | 0x01 | <b>0x68</b> | 0x03 | 0x96 |
|------|------|-------------|------|------|

where:

rrrrrrr = 7 bytes with the remote configuration status (see *Synchronism* packet)

x = checksum (complement to one of the *Length*, *Type* and *Data* field bytes sum)

**g. Teach-in 0x49 reading command ('I' ASCII)**

Reads the pattern with the binary information relative to the shape of the object used in the Teach-in mode.

Host sends:

|      |      |             |      |      |
|------|------|-------------|------|------|
| 0x02 | 0x01 | <b>0x49</b> | 0x03 | 0xB5 |
|------|------|-------------|------|------|

DS2 replies:

|      |      |             |                       |      |   |
|------|------|-------------|-----------------------|------|---|
| 0x02 | 0x22 | <b>0x69</b> | aaa bbb ccc ..... zzz | 0x03 | x |
|------|------|-------------|-----------------------|------|---|

where:

aaa = 3 bytes with Teach-in of the 01-21 photoelements

bbb = 3 bytes with Teach-in of the 22-42 photoelements

ccc = 3 bytes with Teach-in of the 42-63 photoelements

zzz = 3 bytes with Teach-in of the 211-231 photoelements

x = checksum (complement to one of the *Length*, *Type* and *Data* field bytes sum)

The correspondence between the photoelements (21) and the bits of a bytes tern is similar to the *Scanning Result* packet.

**h. Writing command 0x4A Teach-in ('J' ASCII)**

Saves in the DS2 non-volatile memory the new pattern with the binary information relative to the shape of the object to use in the Teach-in mode.

Host sends:

|      |      |             |                       |      |   |
|------|------|-------------|-----------------------|------|---|
| 0x02 | 0x22 | <b>0x4A</b> | aaa bbb ccc ..... zzz | 0x03 | x |
|------|------|-------------|-----------------------|------|---|

DS2 replies:

|      |      |             |      |      |
|------|------|-------------|------|------|
| 0x02 | 0x01 | <b>0x6A</b> | 0x03 | 0x94 |
|------|------|-------------|------|------|

where:

aaa = 3 bytes with Teach-in of the 01-21 photoelements

bbb = 3 bytes with Teach-in of the 22-42 photoelements

ccc = 3 bytes with Teach-in of the 42-63 photoelements

zzz = 3 bytes with Teach-in of the 211-231 photoelements

x = checksum (complement to one of the *Length*, *Type* and *Data* field bytes sum)

The correspondence between the photoelements (21) and the bits of a bytes tern is similar to the *Scanning Result* packet.

**i. Firmware release reading command - 0x4B (ASCII 'K')**

Reads the firmware release.

Host sends:

|      |      |             |      |      |
|------|------|-------------|------|------|
| 0x02 | 0x01 | <b>0x4B</b> | 0x03 | 0xB3 |
|------|------|-------------|------|------|

DS2 replies:

|      |      |             |            |      |   |
|------|------|-------------|------------|------|---|
| 0x02 | 0x0B | <b>0x6B</b> | vvvvvvvvvv | 0x03 | x |
|------|------|-------------|------------|------|---|

where:

vvvvvvvvvv = 10 ASCII codes with the firmware version

x = checksum (complement to one of the *Length*, *Type* and *Data* field bytes sum)

**j. Dip-switch reading command - 0x4C (ASCII 'L')**

Reads the dip-switch status.

Host sends:

|      |      |             |      |      |
|------|------|-------------|------|------|
| 0x02 | 0x01 | <b>0x4C</b> | 0x03 | 0xB2 |
|------|------|-------------|------|------|

DS2 replies:

|      |      |             |   |      |   |
|------|------|-------------|---|------|---|
| 0x02 | 0x02 | <b>0x6C</b> | l | 0x03 | x |
|------|------|-------------|---|------|---|

L = 1 byte with the local configuration status (Dip-switch)

- bit 0 = OutDelay      4B - Output Delay (No Delay/100ms Delay)
- bit 1 = OutMode     3B - Output Mode (NO/NC)
- bit 2 = TeachMode   2B - Teach-in Mode (Absolute/Relative)
- bit 3 = TeachEna    1B - Teach-in Active (Inactive/Active)
- bit 4 = MeasAna     4A - Measurement Analysis Mode (BotTop/Total)
- bit 5 = MeasRef     3A - Measurement Reference Beam (Bottom/Top)
- bit 6 = SerMode     2A - Serial Output Mode (Binary/ASCII)
- bit 7 = ProgMode    1A - Programming Mode (Local/Remote)

x = checksum (complement to one of the *Length*, *Type* and *Data* field bytes sum)

**k. LEDs piloting command - 0x4D ('M' ASCII)**

Turns on and/or turns off the panel LEDs.

Host sends:

|      |      |             |       |      |   |
|------|------|-------------|-------|------|---|
| 0x02 | 0x04 | <b>0x4D</b> | p f o | 0x03 | x |
|------|------|-------------|-------|------|---|

DS2 replies:

|      |      |             |      |      |
|------|------|-------------|------|------|
| 0x02 | 0x01 | <b>0x6D</b> | 0x03 | 0x91 |
|------|------|-------------|------|------|

where:

p = 1 byte with the Power LED status (0 off, 1 on)

f = 1 byte with the Failure LED status (0 off, 1 on)

o = 1 byte with Output LED status (0 off, 1 on)

x = checksum (complement to one of the *Length*, *Type* and *Data* field bytes sum)

**l. PNP/NPN output piloting command - 0x4E ('N' ASCII)**

Turns on and/or turns off the PNP/NPN output.

Host sends:

|      |      |             |   |      |   |
|------|------|-------------|---|------|---|
| 0x02 | 0x02 | <b>0x4E</b> | o | 0x03 | x |
|------|------|-------------|---|------|---|

DS2 replies:

|      |      |             |      |      |
|------|------|-------------|------|------|
| 0x02 | 0x01 | <b>0x6E</b> | 0x03 | 0x90 |
|------|------|-------------|------|------|

where:

o = 1 byte with the PNP/NPN output status (0 off, 1 on)

x = checksum (complement to one of the Length, Type and Data field bytes sum)

**m. Analogue output piloting command - 0x4F ('O' ASCII)**

Sets the analogue output level.

Host sends:

|      |      |             |   |      |   |
|------|------|-------------|---|------|---|
| 0x02 | 0x02 | <b>0x4F</b> | p | 0x03 | x |
|------|------|-------------|---|------|---|

DS2 replies:

|      |      |             |      |      |
|------|------|-------------|------|------|
| 0x02 | 0x01 | <b>0x6F</b> | 0x03 | 0x8F |
|------|------|-------------|------|------|

where:

p = 1 byte with the analogue output percentage (0 = 0V, 100 = 10V)

x = checksum (complement to one of the Length, Type and Data field bytes sum)

**n. A/D Photoelement Conversion Reading Command - 0x50 ('P' ASCII)**

Reads the result of the A/D conversion for an expansion of 21 photoelements.

Host sends:

|      |      |             |   |      |   |
|------|------|-------------|---|------|---|
| 0x02 | 0x02 | <b>0x50</b> | e | 0x03 | x |
|------|------|-------------|---|------|---|

DS2 replies:

|      |      |             |           |      |   |
|------|------|-------------|-----------|------|---|
| 0x02 | 0x16 | <b>0x70</b> | a ..... n | 0x03 | x |
|------|------|-------------|-----------|------|---|

where:

e = 1 byte with the expansion number to read (1 to 21)

a = 1 byte with the result in bit of the conversion for the photoelement 1

n = 1 byte with the result in bit of the conversion for the photoelement 21

x = checksum (complement to one of the *Length, Type and Data* field bytes sum)

The result of a conversion can be interpreted as follows:

$$V_{\text{Photoelement}} [ \text{mV} ] = \text{Bit}_{\text{Photoelement}} * 5000 / 255$$

Note: the 3 less important bits of a conversion [2-0] have to be zeroed before the calculation.

The scanning times vary and depend on different factors such as the number of photoelements, the serial transmission speed, the measurement type selected and the binary or ASCII data format. The values can vary from a minimum of 8 reaching a maximum of 90 milliseconds.

The serial transmission parameters are:







| Baud-rate | Equity | Data bits | Stop bits |
|-----------|--------|-----------|-----------|
| 9600      | None   | 8         | 1         |
| 19200     |        |           |           |
| 38400     |        |           |           |
| 57600     |        |           |           |

## 8. DIAGNOSTIC FUNCTIONS AND LED INTERFACE ERROR SIGNALLING

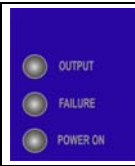
### 8.1. Device status visualisation

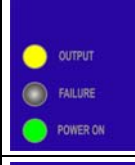
The operator can verify the device functioning status using the three LEDs present the receiver unit and the one present on the emitter unit.

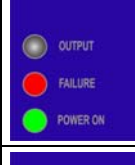
The meaning of the LEDs present of the receiver unit (RX) depends on the light grid operating mode.

| <b>RECEIVING UNIT (RX)</b>  |  |
|---|--|
| Signalling  | Status   |
|    | - No power supply.<br>- Microprocessor in the reset condition.       |
|    | - Normal RX functioning  |
|   | - Presence of object inside sensitive area or units misaligned.      |
|  | - Short-circuit signalling on switching output                       |
|  | - Generic anomaly on RX unit   |
|  | - Critical alignment of the TX and RX units or weak received signal. |

### **EMITTER UNIT (TX)**

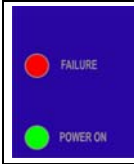
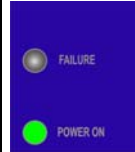
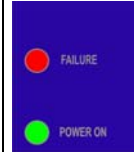
| Signalling  | Status   | Signalling  | Status                                   |
|---|--|---|--|
|  | - No power supply.<br>- Microprocessor in the reset condition. |  | - Generic anomaly of the TX unit         |
|  | Normal TX functioning  |  | - No synchronism between RX and TX units |

## 9. CHECKS AND PERIODICAL MAINTENANCE

The following is a list of recommended check and maintenance operations that should be periodically carried out by qualified personnel.

Check that:

- The operating distance and the alignment of the two units conforms to the indications given in section 2 "Installation mode" and section 10 "Technical data".
- The DS2 device and external electrical connections are not damaged.

The frequency of the checks depends on the particular application and operating conditions of the light grid.



The **AREAscan™** devices of the DS2 series do not require particular maintenance, with the exception of the cleaning of the protective surfaces of the optics.

Use a cotton cloth dampened with water for cleaning.

**Do not use under any circumstances:**

- **alcohol or solvents**
- **wool cloths of synthetic fabric**



Disturbances that generate power supply shifts or lacks can open temporarily the outputs but do not compromise the functioning of the light grid.

All appliances are under a 36 month guarantee from the manufacturing date. DATALOGIC AUTOMATION will not be liable for any damages to persons and things caused by the non-observance of the correct installation modes and device use.

The warranty will not cover damages caused by incorrect installation, incorrect use and accidental causes such as bumps or falls.



In presence of problems, please contact the DATALOGIC AUTOMATION Technical Support:

**Technical Support**

Tel.: +39 051 6765611

Fax.: +39 051 6759324

## 10. TECHNICAL DATA

|  | DS2-05-07-xxx-JV   | DS2-05-25-xxx-JV |
|--|--|------------------|
| Power supply:  | 24 Vdc $\pm$ 20%   |                  |
| Consumption of emitter unit:   | 250 mA max without load  |                  |
| Outputs:   | 1 switching output; load max 10 k $\Omega$<br>load min 100 $\Omega$<br>1 analogue output ; 0-10 V ( $\Delta V_{max}$ 2%) |                  |
| Output current on switching output:  | 100 mA; short-circuit protection   |                  |
| Output voltage on switching output:  | -1.5 Vmax of the power supply<br>at T=25°C   |                  |
| Response time:   | See table "Response time" below  |                  |
| Emission type:   | Infrared (880 nm)  |                  |
| Resolution:  | 12 mm  | 35 mm            |
| Relative measurement precision:  | $\pm$ 6 mm   | $\pm$ 22.5 mm    |
| Absolute measurement precision:  | 6 mm   | 22.5 mm          |
| Dimensional difference between objects<br>equally detected in absolute Teach-in: | $\pm$ 6 mm   | $\pm$ 22.5 mm    |
| Dimensional difference between objects<br>equally detected in relative Teach-in: | $\Delta$ = 12 mm   | $\Delta$ = 45 mm |
| Operating distance:  | 0.3 $\pm$ 5 m  | 0.3 $\pm$ 10 m   |
| Available functions:   | See previous sections  |                  |
| Operating temperature:   | 0 ... + 50 °C  |                  |
| Storage temperature:   | - 25...+ 55 °C   |                  |
| Electrical protection:   | Class I  |                  |
| Mechanical protection:   | IP 65 (EN 60529)   |                  |
| Vibrations:  | 0.5 mm width, 10 ... 55 Hz frequency,<br>(EN 60068-2-6)  |                  |
| Shock resistance:  | 11 ms (30 G) 6 shock for each axis (EN 60068-2-27)   |                  |
| Housing material:  | Painted aluminium (Pulverit 5121/0085 Black)   |                  |
| Lens material:   | PMMA   |                  |
| Connections:   | M12 4-poles connector for TX<br>M12 8-poles connector for RX   |                  |
| Weight:  | Min. 1.9 kg – Max. 4.6 kg  |                  |

### 10.1. Response time

|                  | Tmin<br>(msec)                   |                                 |                                 |                                |                                       |                                       |                                      | Tmax<br>(msec)                       |
|------------------|----------------------------------|---------------------------------|---------------------------------|--------------------------------|---------------------------------------|---------------------------------------|--------------------------------------|--------------------------------------|
|                  |                                  | T2                              | T3                              | T4                             | T5                                    | T6                                    | T7                                   |                                      |
| Model            | Configuration                    |                                 |                                 |                                |                                       |                                       |                                      |                                      |
|                  | Top beam<br>57600 baud<br>binary | Top beam<br>9600 baud<br>binary | Top beam<br>57600 baud<br>ASCII | Top beam<br>9600 baud<br>ASCII | Complete<br>Beams<br>Status<br>binary | Complete<br>Beams<br>Status<br>Binary | Complete<br>Beams<br>Status<br>ASCII | Complete<br>Beams<br>Status<br>ASCII |
| DS2-05-07-015-JV | 5.5                              | 12.5                            | 5.5                             | 13                             | 5.5                                   | 15                                    | 6.5                                  | 10                                   |
| DS2-05-07-030-JV | 7                                | 14                              | 7                               | 14.5                           | 7                                     | 18                                    | 8.5                                  | 21                                   |
| DS2-05-07-045-JV | 8.5                              | 15.5                            | 8.5                             | 16                             | 8.5                                   | 21                                    | 10                                   | 24                                   |
| DS2-05-07-060-JV | 10                               | 17                              | 10                              | 18                             | 10                                    | 26                                    | 12                                   | 38                                   |
| DS2-05-07-075-JV | 11.5                             | 18.5                            | 11.5                            | 19                             | 11.5                                  | 31                                    | 15                                   | 44                                   |
| DS2-05-07-090-JV | 13                               | 20                              | 13                              | 20                             | 13                                    | 36                                    | 17                                   | 54                                   |
| DS2-05-07-105-JV | 14.5                             | 21.5                            | 14.5                            | 22                             | 14.5                                  | 40                                    | 19                                   | 62                                   |
| DS2-05-07-120-JV | 17                               | 24                              | 17                              | 24                             | 17                                    | 44                                    | 21                                   | 70                                   |
| DS2-05-07-135-JV | 18.5                             | 25                              | 19                              | 26                             | 19                                    | 48                                    | 23                                   | 80                                   |
| DS2-05-07-150-JV | 20                               | 26.5                            | 21                              | 28                             | 21                                    | 53                                    | 25                                   | 84                                   |
| DS2-05-07-165-JV | 22                               | 28                              | 23                              | 30                             | 23                                    | 56                                    | 28                                   | 91                                   |
| DS2-05-25-045-JV | 5                                | 11                              | 5                               | 11                             | 5                                     | 13                                    | 6                                    | 18                                   |
| DS2-05-25-060-JV | 5.5                              | 12                              | 5.5                             | 12.5                           | 5.5                                   | 14.5                                  | 6.5                                  | 19.5                                 |
| DS2-05-25-075-JV | 6                                | 13                              | 6                               | 13.5                           | 6                                     | 16                                    | 7                                    | 21                                   |
| DS2-05-25-090-JV | 6.5                              | 13.5                            | 6.5                             | 14.5                           | 6.5                                   | 17.5                                  | 7.5                                  | 22.5                                 |

### 11. LIST OF AVAILABLE MODELS

| Model            | Optics interaxis (mm) | h1 Length of controlled area (mm) | a x b (mm) | h (mm) | N°. beams |
|------------------|-----------------------|-----------------------------------|------------|--------|-----------|
| DS2-05-07-015-JV | 6.75                  | 147                               | 35 x 40    | 256    | 21        |
| DS2-05-07-030-JV | 6.75                  | 294                               | 35 x 40    | 403    | 42        |
| DS2-05-07-045-JV | 6.75                  | 441                               | 35 x 40    | 550    | 63        |
| DS2-05-07-060-JV | 6.75                  | 588                               | 35 x 40    | 697    | 84        |
| DS2-05-07-075-JV | 6.75                  | 735                               | 35 x 40    | 844    | 105       |
| DS2-05-07-090-JV | 6.75                  | 882                               | 35 x 40    | 991    | 126       |
| DS2-05-07-105-JV | 6.75                  | 1029                              | 35 x 40    | 1138   | 147       |
| DS2-05-07-120-JV | 6.75                  | 1176                              | 35 x 40    | 1285   | 168       |
| DS2-05-07-135-JV | 6.75                  | 1323                              | 35 x 40    | 1432   | 189       |
| DS2-05-07-150-JV | 6.75                  | 1470                              | 35 x 40    | 1579   | 210       |
| DS2-05-07-165-JV | 6.75                  | 1617                              | 35 x 40    | 1726   | 231       |
| DS2-05-25-045-JV | 25                    | 453                               | 35 x 40    | 562    | 18        |
| DS2-05-25-060-JV | 25                    | 604                               | 35 x 40    | 713    | 24        |
| DS2-05-25-075-JV | 25                    | 755                               | 35 x 40    | 864    | 30        |
| DS2-05-25-090-JV | 25                    | 912                               | 35 x 40    | 1015   | 36        |

### 12. OVERALL DIMENSIONS

All the values are in mm.

