

**ebm-papst St. Georgen GmbH & Co. KG**

Hermann-Papst-Str. 1

D-78112 St. Georgen

Phone +49 (0) 7724 81-0

Fax +49 (0) 7724 81-1309

info2@de.ebmpapst.com

www.ebmpapst.com

Nominal data

Type	414 F	
Nominal voltage	VDC	24
Nominal voltage range	VDC	20 .. 28
Speed (rpm)	min ⁻¹	5400
Power consumption	W	0.8
Min. ambient temperature	°C	-20
Max. ambient temperature	°C	70
Air flow	m ³ /h	8
Sound power level	B	4.4
Sound pressure level	dB(A)	22.1

ml = Max. load · me = Max. efficiency · fa = Free air · cs = Customer specification · ce = Customer equipment
Subject to change



Technical description

Weight	0.017 kg
Dimensions	40 x 40 x 10 mm
Impeller material	Glass-fiber reinforced PA plastic
Housing material	Glass-fiber reinforced PBT plastic
Airflow direction	Exhaust over struts
Direction of rotation	Counterclockwise, viewed toward rotor
Storage	Sintec sleeve bearing system
Service life L10 at 20 °C	45000 h
Service life L10 at 60 °C	17500 h
Cable	Leads AWG 28, TR 64, stripped and tin-plated.
Motor protection	Protection against reverse polarity and blocked rotor.
Approval	VDE, CSA, UL
Option	Possible custom designs: Speed signal Go / No-go alarm Moisture protection



Product drawing

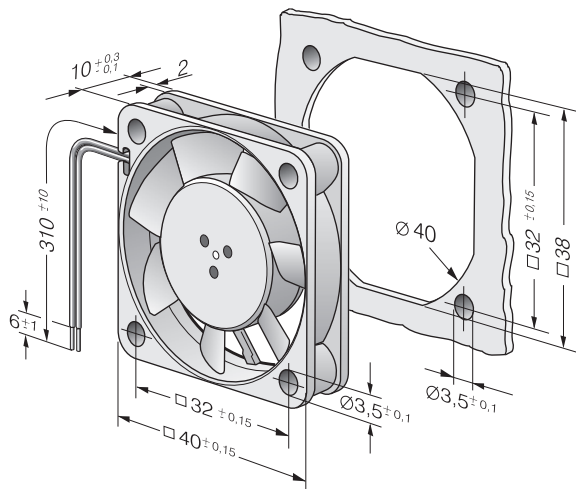

Curves: Air performance

