

**ebm-papst St. Georgen GmbH & Co. KG**

Hermann-Papst-Str. 1

D-78112 St. Georgen

Phone +49 (0) 7724 81-0

Fax +49 (0) 7724 81-1309

info2@de.ebmpapst.com

www.ebmpapst.com

Nominal data

Type	8550 A	
Phase		1~
Nominal voltage	VAC	230
Frequency	Hz	50
Speed (rpm)	min ⁻¹	2700
Power consumption	W	12.0
Min. ambient temperature	°C	-10
Max. ambient temperature	°C	70
Air flow	m ³ /h	48
Sound power level	B	5.0
Sound pressure level	dB(A)	36

ml = Max. load · me = Max. efficiency · fa = Free air · cs = Customer specification · ce = Customer equipment
Subject to change



Technical description

Weight	0.490 kg
Dimensions	80 x 80 x 38 mm
Impeller material	Metal
Housing material	Metal
Part no.	9244014602
Airflow direction	Intake over struts
Direction of rotation	Clockwise, viewed toward rotor
Storage	Sintec sleeve bearing system
Service life L10 at 40 °C	52500 h
Service life L10 at maximum temperature	25000 h
Cable	2 flat plugs 2.8 x 0.5 mm
Motor protection	Protected from overload by impedance protection
Approval	VDE, CSA, UL, CE
Option	Optionally available with electrical hookup to leads. Optionally available with exhaust over struts and clockwise rotation.

Product drawing

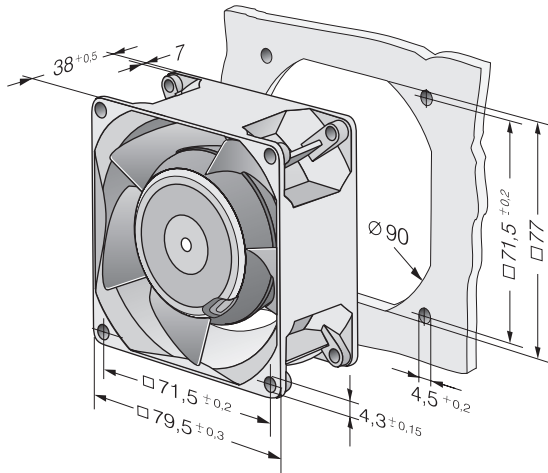

Curves: Air performance

