

SG4-FINGER SERIES

The series of **SAFEasy™ SG4-B FINGER** safety light curtains widens the existing **SG** range, whilst representing an evolution of the **SE4-PLUS** line, offering a Type 4 safety light device for finger protection with base functions. Ideal for applications that do not require complementary functions such as Muting, Cascade and blanking.

The **SG4-B** series has been especially developed to simplify:

- installation (new rotating TOP-BOTTOM fixing brackets to ease alignment);
- connection (use of standard connectors, no connection between emitter and receiver necessary);
- configuration (no external control units and / or supplementary cables necessary);
- use (alignment guided by a 7 segment double display on both units).

Improved response time and operating distance, respect to the **SE4-PLUS** series distinguish this series and make it one of the best performing light curtains available today on the market.



HIGHLIGHTS

- Integrated light curtain for FINGER PROTECTION (14 mm resolution)
- Maximum operating distance reaching 6 m
- Controlled heights ranging from 150 to 1800 mm
- Compact 32x37 mm profile
- Selectable EDM and Manual/ Automatic Restart

APPLICATIONS

- Automatic machines;
- Packaging and cutting machines;
- Textile, wood-working and ceramic machines;
- Automatic assembling lines;
- Milling, lathe and shearing machines;
- Bending and metal-working machines.



The main characteristics of the SG4-B FINGER are:

- Operating distance reaching 6 m
- Response time from 11 to 50 msec
- Controlled heights ranging from 150 to 1800 mm
- New sturdy and more functional profile
- Compatibility with the entire SE accessory range
- Selectable EDM and Manual/Automatic Restart
- User interface equipped with a 7 segment display on both TX and RX units
- Alignment aid function

DIMENSIONS

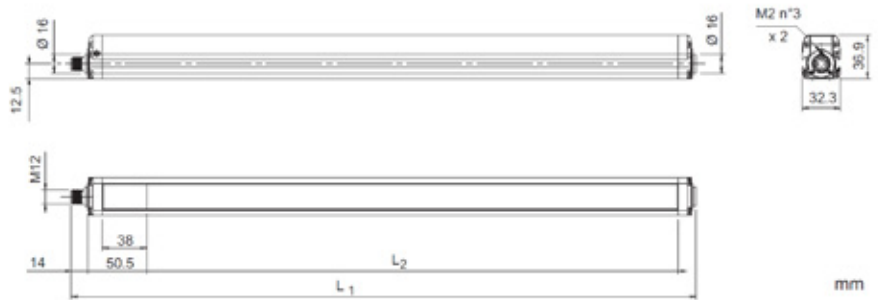

VERSION	L ₁	L ₂
SG4-14-015-OO-E	233.3	153.3
SG4-14-030-OO-E	383.2	303.2
SG4-14-045-OO-E	533.2	453.3
SG4-14-060-OO-E	683.2	603.2
SG4-14-075-OO-E	833.2	753.3
SG4-14-090-OO-E	983.2	903.2
SG4-14-105-OO-E	1133.2	1053.2
SG4-14-120-OO-E	1283.3	1203.3
SG4-14-135-OO-E	1433.2	1353.2
SG4-14-150-OO-E	1583.3	1503.3
SG4-14-165-OO-E	1733.3	1653.3
SG4-14-180-OO-E	1883.3	1803.3

INDICATORS AND SETTINGS

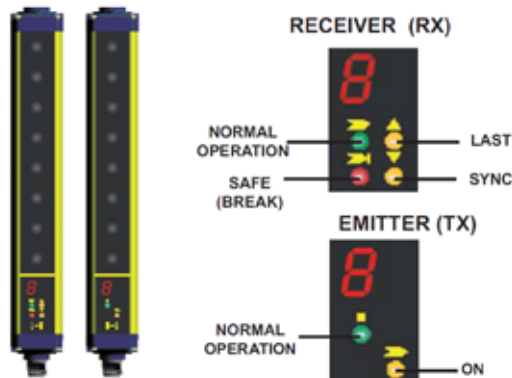

CONNECTIONS

RX: M12 8-POLE CONNECTOR

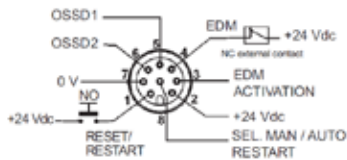

- | | |
|------------|----------------------------|
| 1 = white | = RESET (*) |
| 2 = brown | = +24 Vdc |
| 3 = green | = EDMACTIVATION (**) |
| 4 = yellow | = EDM |
| 5 = grey | = OSSD1 |
| 6 = pink | = OSSD2 |
| 7 = blue | = 0 V |
| 8 = red | = SEL. MAN. / AUTO RESTART |

*Automatic RESTART - RESET function
Manual RESTART - RESET/RESTART function
**Refer to "SG4-B: functions"

NOTE: For MANUAL RESTART CONNECT TOGETHER Pin8 with Pin6.
For Automatic Restart connect together Pin8 with Pin5

TX: M12 4-POLE CONNECTOR

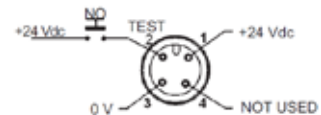

- | | |
|-----------|------------|
| 1 = brown | = +24 Vdc |
| 2 = white | = TEST |
| 3 = blue | = 0 V |
| 4 = black | = NOT USED |

SG4-B: FUNCTIONS

EDM

The **EDM** function allows to connect the light barrier to a couple of simple forced-guided safety relays instead to a Type 4 safety relay and thus guaranteeing an enormous economical advantage.

Connection with EDM function

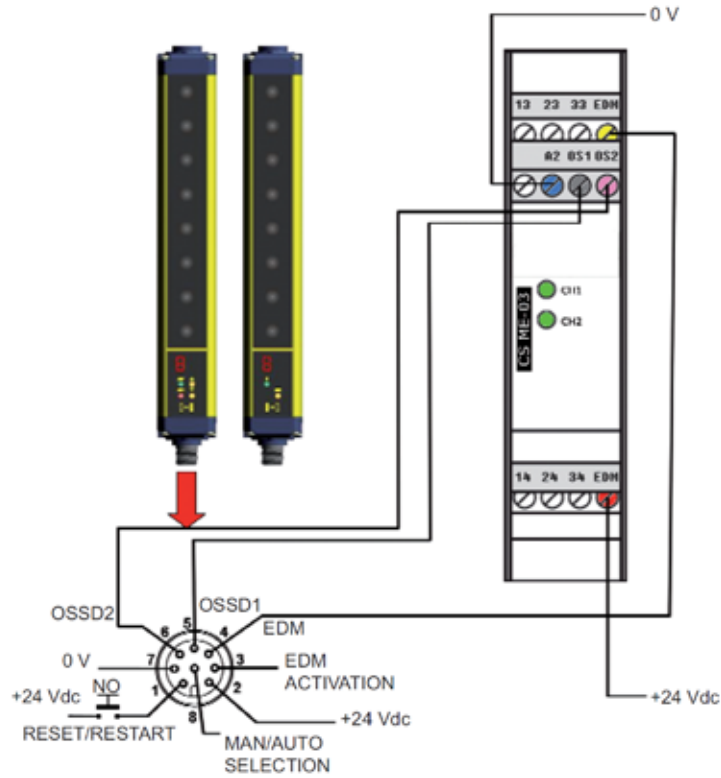

Connection without EDM function

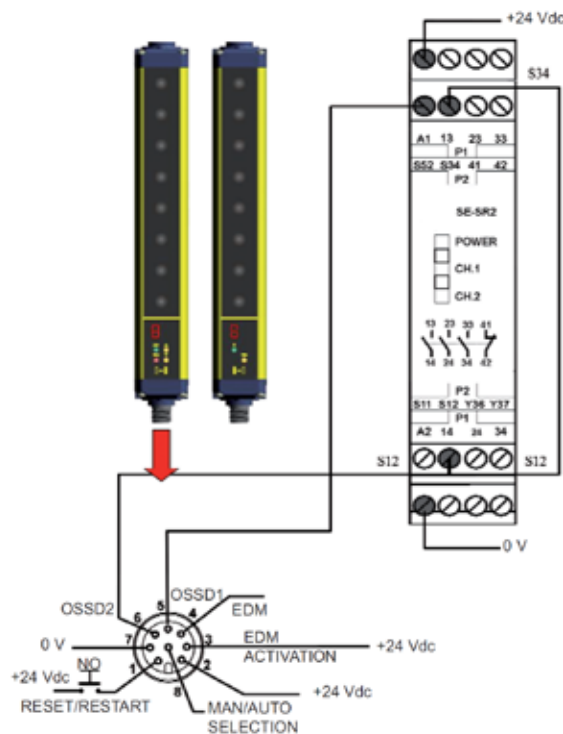

TECHNICAL DATA

Electrical Data	
Power supply (Vdd)	24 Vdc ± 20%
Consumption (TX):	2.5 W max
Consumption (RX):	4 W max (without load)
OSSD outputs:	2 PNP
Short-circuit protection:	1.4 A max
Output current:	0.5 A max on each output
Output voltage – ON status:	Vdd-1 V
Output voltage – OFF status:	0.2 V
Leakage current:	< 1mA
Capacitive load:	2.2 uF @ 24Vdc (*)
Response time:	Refer to table
Controlled height:	150 ... 1800 mm
Safety category:	Type 4
Auxiliary functions:	Reset/Test
	Selectable Man./ Auto. Restart
	Selectable EDM
Electrical protection:	Class I / Class III
Connections:	M12 4-pole for emitter
	M12 8-pole for receiver
Cable length (for powering)	50 m. max (*)
OPTICAL DATA	
Light emission:	Infrared LED (950 nm)
Resolution:	14 mm
Operating distance:	0.2...6 m
Aperture angle (EAA):	±2.5°
Ambient light rejection:	IEC 61496-2
MECHANICAL AND ENVIRONMENTAL DATA	
Operating temperature:	0...55°C
Storage temperature:	-25...+ 70 °C
Temperature class:	T6
Humidity:	15...95 % (non condensating)
Mechanical protection:	IP65 (EN 60529)
Vibrations:	Width 0.35 mm
	Frequency 10 ... 55 Hz 20 sweep per axis, 1 octave/min (EN 60068-2-6)
Shock resistance:	16 ms (10g) 1.000 shock per axis (EN 60068-2-29)
Housing material:	Painted aluminium (yellow RAL 1003)
Protective shield material:	PMMA
Cap material:	PC MAKROLON
Weight:	1.3 Kg / m

*If a longer cable has to be used, please verify that the capacitive load specifications are respected

TABLES

MODEL	
SG4 height 150	16
SG4 height 300	32
SG4 height 450	48
SG4 height 600	64
SG4 height 750	80
SG4 height 900	96
SG4 height 1050	112
SG4 height 1200	128
SG4 height 1350	144
SG4 height 1500	160
SG4 height 1650	176
SG4 height 1800	192

Table 1: NUMBER OF CONTROLLED BEAMS

MODEL	
SG4 height 150	150
SG4 height 300	300
SG4 height 450	450
SG4 height 600	600
SG4 height 750	750
SG4 height 900	900
SG4 height 1050	1050
SG4 height 1200	1200
SG4 height 1350	1350
SG4 height 1500	1500
SG4 height 1650	1650
SG4 height 1800	1800

Table 2: CONTROLLED HEIGHT (mm)

MODEL	
SG4 height 150	11
SG4 height 300	15
SG4 height 450	18
SG4 height 600	22
SG4 height 750	25
SG4 height 900	29
SG4 height 1050	33
SG4 height 1200	36
SG4 height 1350	40
SG4 height 1500	43
SG4 height 1650	47
SG4 height 1800	50

Table 3: RESPONSE TIME (ms)



FIXING BRACKET

Rotating fixing bracket¹

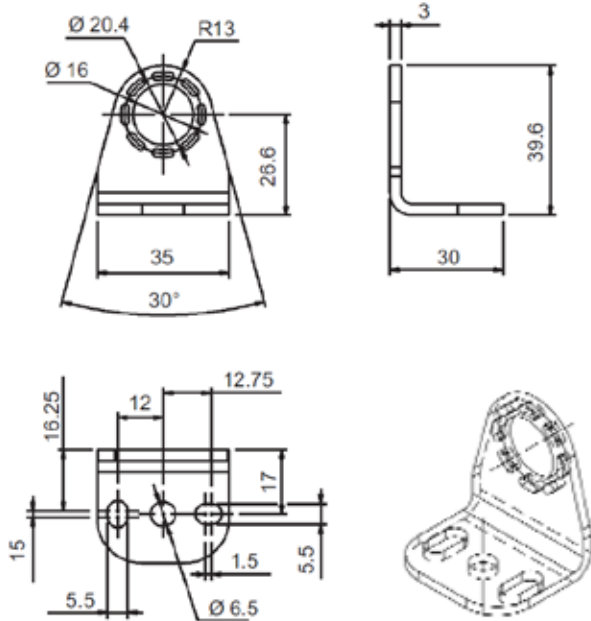

¹ Accessory sold separately

Angled fixing bracket²

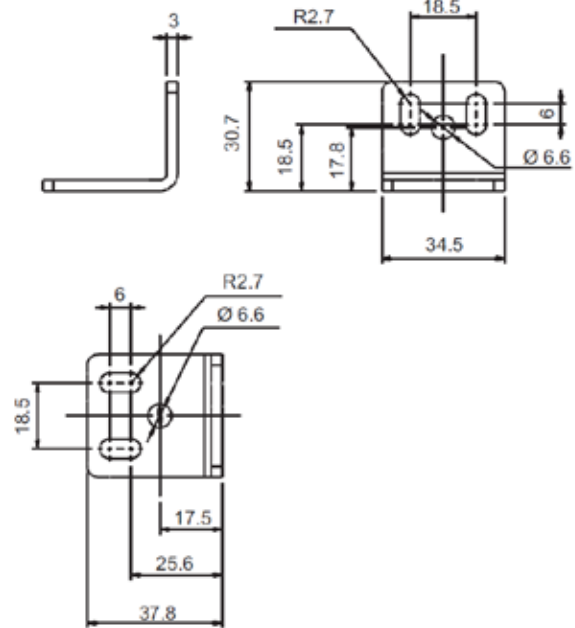

² Supplied in the package

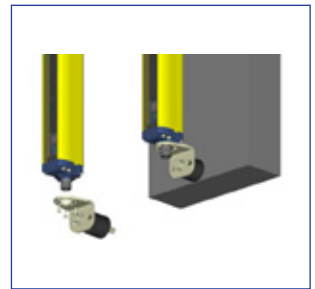
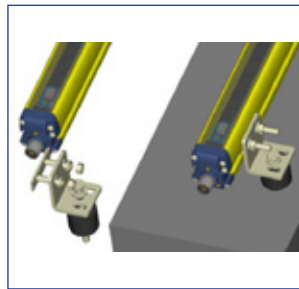
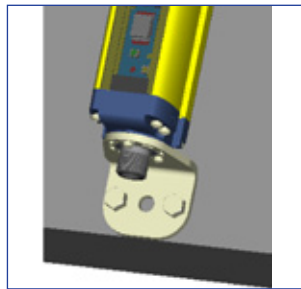

Installation with anti-vibration supports

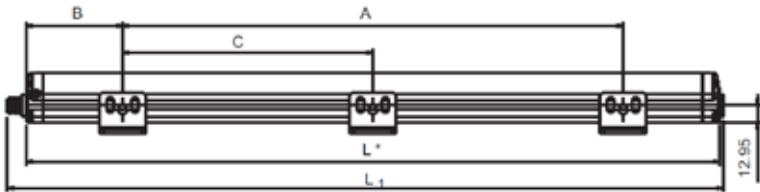

MODELS	L (mm)	A (mm)	B (mm)	C (mm)
SG4-14-015-OO-E	216.3	108	54	-
SG4-14-030-OO-E	366.2	216	75	-
SG4-14-045-OO-E	516.3	316	100	-
SG4-14-060-OO-E	666.2	366	150	-
SG4-14-075-OO-E	816.3	466	175	-
SG4-14-090-OO-E	966.2	566	200	-
SG4-14-105-OO-E	1116.2	666	225	-
SG4-14-120-OO-E	1266.3	966	150	483
SG4-14-135-OO-E	1416.2	1066	175	533
SG4-14-150-OO-E	1566.3	1166	200	583
SG4-14-165-OO-E	1716.3	1266	225	633
SG4-14-180-OO-E	1866.3	1366	250	683

RELIABILITY DATA SG4-B

PL (Ref. EN ISO 13849-1)	e
CAT (Ref. EN 954-1)	4
SIL (Ref. EN IEC 61508)	3
SIL CL (Ref. EN IEC 62061)	3
PFHD – Probability of Danger Failure (1/h)	2,64E-09
T1 – Life Time (Years)	20
MTTFD - Mean Time to Danger Failure (Years)	444
DC – Diagnostic Coverage (%)	98,80%
SFF – Safe Failure Fraction (%)	99,30%
HFT – Hardware Fault Tolerance	1

MODEL SELECTION AND ORDER INFORMATION

Model	Description	Order N°
SG4-14-015-OO-E	Type 4 safety light curtain h=150 mm	957901000
SG4-14-030-OO-E	Type 4 safety light curtain h=300 mm	957901010
SG4-14-045-OO-E	Type 4 safety light curtain h=450 mm	957901020
SG4-14-060-OO-E	Type 4 safety light curtain h=600 mm	957901030
SG4-14-075-OO-E	Type 4 safety light curtain h=750 mm	957901040
SG4-14-090-OO-E	Type 4 safety light curtain h=900 mm	957901050
SG4-14-105-OO-E	Type 4 safety light curtain h=1050 mm	957901060
SG4-14-120-OO-E	Type 4 safety light curtain h=1200 mm	957901070
SG4-14-135-OO-E	Type 4 safety light curtain h=1350 mm	957901080
SG4-14-150-OO-E	Type 4 safety light curtain h=1500 mm	957901090
SG4-14-165-OO-E	Type 4 safety light curtain h=1650 mm	957901100
SG4-14-180-OO-E	Type 4 safety light curtain h=1800 mm	957901110

ACCESSORY SELECTION AND ORDER INFORMATION

Model	Description	Order N°
CS-A1-02-U-03	M12 4-pole unshielded axial 3 m connector, UL 2464	95ASE1120
CS-A1-02-U-05	M12 4-pole unshielded axial 5 m connector, UL 2464	95ASE1130
CS-A1-02-U-10	M12 4-pole unshielded axial 10 m connector, UL 2464	95ASE1140
CS-A1-02-U-15	M12 4-pole unshielded axial 15 m connector, UL 2464	95ASE1150
CS-A1-02-U-25	M12 4-pole unshielded axial 25 m connector, UL 2464	95ASE1160
CS-A1-06-U-03	M12 8-pole unshielded axial 3 m connector, UL 2464	95ASE1220
CS-A1-06-U-05	M12 8-pole unshielded axial 5 m connector, UL 2464	95ASE1230
CS-A1-06-U-10	M12 8-pole unshielded axial 10 m connector, UL 2464	95ASE1240
CS-A1-06-U-15	M12 8-pole unshielded axial 15 m connector, UL 2464	95ASE1250
CS-A1-06-U-25	M12 8-pole unshielded axial 25 m connector, UL 2464	95ASE1260
ST-KSTD	Angled fixing brackets (4 pc kit)	95ACC1670
ST-K4AV	Anti-vibration supports (4 pc kit)	95ACC1700
ST-K6AV	Anti-vibration supports (6 pc kit)	95ACC1710
ST-K4ROT	Top-Bottom rotating fixing brackets (4 pc kit)	95ASE1280

Please refer also to **Safety Device Accessories**



The company endeavours to continuously improve and renew its products; for this reason the technical data and contents of this catalogue may undergo variations without prior notice. For correct installation and use, the company can guarantee only the data indicated in the instruction manual supplied with the products.