

Smart Power Supply

S8AS

CSM_S8AS_DS_E_6_1

A New Type of Power Supply That Provides Safety and Maintainability



- 240- and 480-W power supplies with and digital circuit protectors in a single package.
- Each branch output tripping current value can be easily set at 0.1-A increments.
- Startup and shutdown sequence control included.
- Various monitor displays and alarms (output voltage, output current, maintenance forecast monitor, temperature).
- Conforms to UL Class 2
- Mounts to DIN Rail.



Refer to *Safety Precautions for All Power Supplies* and *Safety Precautions* on page 23.

Model Number Structure

Model Number Legend

S8AS-
 1 2 3

1. Capacity

240: 240 W
 480: 480 W

2. Number of Output Branches

06: 6 branch outputs
 08: 8 branch outputs

3. Additional Functions

Blank: Changeable parameter settings with no communications
 N: Unchangeable parameter settings with no communications
 R: Changeable parameter settings with communications (RS-485)

Ordering Information

S8AS

Capacity	Input voltage	Output voltage	Maximum cutoff output current (per branch)	Total output current	Number of output branches	Communications functions	Parameter settings	Model
240 W	100 to 240 VAC	24 V	3.8 A	10 A	6 branch outputs	None	Changeable	S8AS-24006
						None	Not changeable	S8AS-24006N
						RS-485	Changeable	S8AS-24006R
480 W	100 to 240 VAC	24 V	3.8 A	20 A	8 branch outputs	None	Changeable	S8AS-48008
						None	Not changeable	S8AS-48008N
						RS-485	Changeable	S8AS-48008R

Be sure to read and fully understand the content of the *S8AS User's Manual (Cat. No. Z269)* before changing settings on the S8AS.

Specifications

S8AS-24006□

Item	Model	S8AS-24006	S8AS-24006N	S8AS-24006R	
Efficiency (Typ.)		80% min.			
Input conditions	Voltage range *1		100 to 240 VAC (85 to 264 VAC)		
	Frequency *1		50/60 Hz (47 to 63 Hz)		
	Current	100-V input	3.8 A max.		
		200-V input	2.0 A max.		
	Power factor		0.95 min.		
	Harmonic current		EN61000-3-2		
	Leakage current	100-V input	0.5 mA max.		
		200-V input	1.0 mA max.		
Inrush current *2	100-V input	25 A max. (for a cold start at 25°C)			
	200-V input	50 A max. (for a cold start at 25°C)			
Output conditions	Number of branches		6		
	Maximum cutoff output current (per branch)		3.8 A		
	Total output current		10 A		
	Allowable voltage range *3		±10% (with V.ADJ)		
	Ripple noise voltage		2.0% [P-P] max. (for rated input and output voltage) *4		
	Output leakage current		10 mA max.		
	Input fluctuation		0.5% max. (Input: 85 to 264 VAC, 100% load) *5		
	Load fluctuation (rated input voltage)		4.0% max. (rated input, 0% to 100% load) *5		
	Temperature fluctuation		0.05%/°C max.		
	Startup time *2		3,000 ms max. (for rated input and output voltage) *4		
Output hold time *2		20 ms max. (for rated input and output voltage) *4			
Functions	Tripping functions	Abnormal voltage tripping		28.8 V (Cannot be changed.)	
		Abnormal current tripping *2		Setting range: 0.5 to 3.8 A (in 0.1-A increments) 3.8 A (Cannot be changed.) Setting range: 0.5 to 3.8 A (in 0.1-A increments)	
		Abnormal total current tripping		Branch outputs are cut off when the total output current is more than 17 A for 2 s, 15 A for 5 s, 13 A for 10 s, or 12 A for 20 s.	
		Tripping alarm output		Photoswitch output 30 VDC max. and 50 mA max., Leakage current: 0.1 mA max., Residual voltage: 2 V max.	
	Undervoltage detection functions	Undervoltage detection		Setting range: 18.0 to 26.4 V (in 0.1-V increments) 20.0 V (Cannot be changed.) Setting range: 18.0 to 26.4 V (in 0.1-V increments)	
		Undervoltage detection output		Photoswitch output 30 VDC max. and 50 mA max., Leakage current: 0.1 mA max., Residual voltage: 2 V max.	
	Maintenance forecast monitor function	Maintenance forecast monitor		Setting range: 0.0 to 5.0 yr (in 0.5-yr increments) 0.5 yr (Cannot be changed.) Setting range: 0.0 to 5.0 yr (in 0.5-yr increments)	
		Maintenance forecast monitor output		Photoswitch output 30 VDC max. and 50 mA max., Leakage current: 0.1 mA max., Residual voltage: 2 V max.	
	Over-temperature detection function	Over-temperature		Setting range: 25 to 90°C (in 1°C increments) 90°C (Cannot be changed.) Setting range: 25 to 90°C (in 1°C increments)	
		Over-temperature output		Photoswitch output 30 VDC max. and 50 mA max., Leakage current: 0.1 mA max., Residual voltage: 2 V max.	
	Display functions	Output voltage display		Display range: 17.0 to 30.0 V Display accuracy: 2% rdg ±1 digit max.	
		Output current display		Branch output display range: 0.0 to 4.0 A Peak output current display range: 0.0 to 20.0 A Total current display range: 0.0 to 40.0 A Display accuracy: 5% FS (4 A) ±1 digit max.	
		Maintenance forecast monitor display		Display range: FUL (Full)/HLF (Half)/0.0 to 5.0 yr	
		Temperature display		Display range: -20 to 100°C Display accuracy: 2°C ±1 digit max.	
	External Tripping Input		The input can be enabled or disabled for each branch output. 19.2 to 30.0 VDC, minimum signal width: 10 ms, tripping after input within 20 ms + the shutdown sequence set time	All branch outputs: Enabled (Cannot be changed.) 19.2 to 30.0 VDC, minimum signal width: 10 ms, tripping after input within 20 ms + the shutdown sequence set time	The input can be enabled or disabled for each branch output. 19.2 to 30.0 VDC, minimum signal width: 10 ms, tripping after input within 20 ms + the shutdown sequence set time
	Startup sequence		Setting range: 0.0 to 99.9 s in 0.1-s increments	Branch output 1: 0.0 s (Cannot be changed.) Branch output 2: 0.4 s (Cannot be changed.) Branch output 3: 0.8 s (Cannot be changed.) Branch output 4: 1.2 s (Cannot be changed.) Branch output 5: 1.6 s (Cannot be changed.) Branch output 6: 2.0 s (Cannot be changed.)	Setting range: 0.0 to 99.9 s in 0.1-s increments
Shutdown sequence		Setting range: 0.0 to 99.9 s in 0.1-s increments	All branch outputs: 0.0 s (Cannot be changed.)	Setting range: 0.0 to 99.9 s in 0.1-s increments	
Communications		Not supported		Supported (RS-485)	
Sampling period		1 ms			
Parallel connection		Not supported			
Series connection		Not supported			

Note: Refer to the next page for information on *1 to *5.

Item	Model	S8AS-24006	S8AS-24006N	S8AS-24006R
Others	Ambient operating temperature	Refer to the derating curve (no icing or condensation). *2		
	Storage temperature	-25 to 65°C		
	Ambient operating humidity	25% to 85% (storage: 25% to 90%)		
	Withstand voltage	3.0 kVAC for 1 min between all input terminals collectively and all branch output, all I/O signal, and all communications terminals collectively (Detection current: 20 mA) 2.0 kVAC for 1 min between all inputs and protective earth (Detection current: 20 mA) 1.0 kVAC for 1 min between protective earth and all branch output, all I/O signal, and all communications terminals collectively (Detection current: 20 mA) 500 VAC for 1 min between all branch output and all I/O signal/communications terminals collectively (Detection current: 20 mA) 500 VAC for 1 min between all I/O signal terminals collectively and communications terminals collectively (Detection current: 20 mA) 500 VAC for 1 min between all I/O signal terminals collectively and all output signal terminals collectively (detection current: 20 mA)		
	Insulation resistance	100 MΩ min. at 500 VDC between the protective earth terminal or all input terminals collectively and all branch output, all I/O signal, and all communications terminals collectively		
	Vibration resistance	No abnormality after 10 to 55 Hz at 0.375-mm single amplitude for 2 h each in 3 directions.		
	Shock resistance	No abnormality after 150 m/s ² 3 times each in 6 directions.		
	Output indicator	Provided (Color: green)		
	Conducted EMI	Conforms to EN 61204-3 Class A and FCC Class A.		
	Radiated EMI	Conforms to EN 61204-3 Class A.		
	Safety standards	cULus: UL508 (Listing, Class2: Per UL1310), CSA C22.2 No.107.1 (Class2: Per CSA C22.2 No.22.3) cURus: UL60950-1, CSA C22.2 No.60950-1 EN: EN50178, EN60950-1 VDE: VDE0160, VDE0805 Teil1		
	SEMI standard	SEMI F47-0706 (200 VAC input)		
	Weight	1,600 g max.		

*1. Do not use an inverter output for the Power Supply. Inverters with an output frequency of 50/60 Hz are available, but the rise in the internal temperature of the Power Supply may result in ignition or burning.

*2. Refer to *Engineering Data* on page 8 for details.

*3. If the output voltage adjuster (V. ADJ) is turned, the voltage will increase by more than 10% of the voltage adjustment range. When adjusting the output voltage, confirm the actual output voltage from the Power Supply and be sure that the load is not damaged. If the output voltage exceeds 28.8 V, all branch outputs will be cut off.

*4. Rated input and output conditions: Rated input voltage, rated frequency, rated output voltage, rated total output current, and maximum cutoff output current.

*5. 100% load conditions: Rated output voltage, rated total output current, and maximum cutoff output current.

S8AS-48008□

Item	Model	S8AS-48008	S8AS-48008N	S8AS-48008R	
Efficiency (Typ.)		80% min.			
Input conditions	Voltage range *1	100 to 240 VAC (85 to 264 VAC)			
	Frequency *1	50/60 Hz (47 to 63 Hz)			
	Current	100-V input	7.4 A max.		
		200-V input	3.9 A max.		
	Power factor	0.95 min.			
	Harmonic current	EN61000-3-2			
	Leakage current	100-V input	0.5 mA max.		
		200-V input	1.0 mA max.		
Inrush current *2	100-V input	25 A max. (for a cold start at 25°C)			
	200-V input	50 A max. (for a cold start at 25°C)			
Output conditions	Number of branches	8			
	Maximum cutoff output current (per branch)	3.8 A			
	Total output current	20 A			
	Allowable voltage range *3	±10% (with V.AD.J)			
	Ripple noise voltage	2.0%[P-P] max. (for rated input and output voltage) *4			
	Output leakage current	10 mA max.			
	Input fluctuation	0.5% max. (Input: 85 to 264 VAC, 100% load) *5			
	Load fluctuation (rated input voltage)	4.0% max. (rated input, 0% to 100% load) *5			
	Temperature fluctuation	0.05%/°C max.			
	Startup time *2	3,000 ms max. (for rated input and output voltage) *4			
Output hold time *2	20 ms min. (for rated input and output voltage) *4				
Functions	Tripping functions	Abnormal voltage tripping	28.8 V (Cannot be changed.)		
		Abnormal current tripping *2	Setting range: 0.5 to 3.8 A (in 0.1-A increments)	3.8 A (Cannot be changed.)	Setting range: 0.5 to 3.8 A (in 0.1-A increments)
		Abnormal total current tripping	Branch outputs are cut off when the total output current is more than 27 A for 1 s, 25 A for 2 s, or 22.5 A for 5 s.		
		Tripping alarm output	Photoswitch output 30 VDC max. and 50 mA max., Leakage current: 0.1 mA max., Residual voltage: 2 V max.		
	Undervoltage detection functions	Undervoltage detection	Setting range: 18.0 to 26.4 V (in 0.1-V increments)	20.0 V (Cannot be changed.)	Setting range: 18.0 to 26.4 V (in 0.1-V increments)
		Undervoltage detection output	Photoswitch output 30 VDC max. and 50 mA max., Leakage current: 0.1 mA max., Residual voltage: 2 V max.		
	Maintenance forecast monitor function	Maintenance forecast monitor	Setting range: 0.0 to 5.0 yr (in 0.5-yr increments)	0.5 yr (Cannot be changed.)	Setting range: 0.0 to 5.0 yr (in 0.5-yr increments)
		Maintenance forecast monitor output	Photoswitch output 30 VDC max. and 50 mA max., Leakage current: 0.1 mA max., Residual voltage: 2 V max.		
	Over-temperature detection function	Over-temperature	Setting range: 25 to 90°C (in 1°C increments)	90°C (Cannot be changed.)	Setting range: 25 to 90°C (in 1°C increments)
		Over-temperature output	Photoswitch output 30 VDC max. and 50 mA max., Leakage current: 0.1 mA max., Residual voltage: 2 V max.		
	Display functions	Output voltage display	Display range: 17.0 to 30.0 V Display accuracy: 2% rdg ±1 digit max.		
		Output current display	Branch output display range: 0.0 to 4.0 A Peak output current display range: 0.0 to 20.0 A Total current display range: 0.0 to 40.0 A Display accuracy: 5% FS (4 A) ±1 digit max.		
		Maintenance forecast monitor display	Display range: FUL (Full)/HLF (Half)/0.0 to 5.0 yr		
		Temperature display	Display range: -20 to 100°C Display accuracy: 2°C ±1 digit max.		
	External Tripping Input	The input can be enabled or disabled for each branch output. 19.2 to 30 VDC, minimum signal width: 10 ms, tripping after input within 20 ms + the shutdown sequence set time	All branch outputs: Enabled (Cannot be changed.) 19.2 to 30 VDC, minimum signal width: 10 ms, tripping after input within 20 ms + the shutdown sequence set time	The input can be enabled or disabled for each branch output. 19.2 to 30 VDC, minimum signal width: 10 ms, tripping after input within 20 ms + the shutdown sequence set time	
	Startup sequence	Setting range: 0.0 to 99.9 s in 0.1-s increments	Branch output 1: 0.0 s (Cannot be changed.) Branch output 2: 0.4 s (Cannot be changed.) Branch output 3: 0.8 s (Cannot be changed.) Branch output 4: 1.2 s (Cannot be changed.) Branch output 5: 1.6 s (Cannot be changed.) Branch output 6: 2.0 s (Cannot be changed.) Branch output 7: 2.4 s (Cannot be changed.) Branch output 8: 2.8 s (Cannot be changed.)	Setting range: 0.0 to 99.9 s in 0.1-s increments	
Shutdown sequence	Setting range: 0.0 to 99.9 s in 0.1-s increments	All branch outputs: 0.0 s (Cannot be changed.)	Setting range: 0.0 to 99.9 s in 0.1-s increments		
Communications	Not supported		Supported (RS-485)		
Sampling period	1 ms				
Parallel connection	Not supported				
Series connection	Not supported				

Note: Refer to the next page for information on *1 to *5.

Item	Model	S8AS-48008	S8AS-48008N	S8AS-48008R
Others	Ambient operating temperature	Refer to the derating curve (no icing or condensation). *2		
	Storage temperature	-25 to 65°C		
	Ambient operating humidity	25% to 85% (storage: 25% to 90%)		
	Withstand voltage	3.0 kVAC for 1 min between all input terminals collectively and all branch output, all I/O signal, and all communications terminals collectively (Detection current: 20 mA) 2.0 kVAC for 1 min between all inputs and protective earth (Detection current: 20 mA) 1.0 kVAC for 1 min between protective earth and all branch output, all I/O signal, and all communications terminals collectively (Detection current: 30 mA) 500 VAC for 1 min between all branch output and all I/O signal/communications terminals collectively (Detection current: 20 mA) 500 VAC for 1 min between all I/O signal terminals collectively and communications terminals collectively (Detection current: 20 mA) 500 VAC for 1 min between all I/O signal terminals collectively and all output signal terminals collectively (detection current: 20 mA)		
	Insulation resistance	100 MΩ min. at 500 VDC between the protective earth terminal or all input terminals collectively and all branch output, all I/O signal, and all communications terminals collectively		
	Vibration resistance	No abnormality after 10 to 55 Hz at 0.375-mm single amplitude for 2 h each in 3 directions.		
	Shock resistance	No abnormality after 150 m/s ² 3 times each in 6 directions.		
	Output indicator	Provided (Color: green)		
	Conducted EMI	Conforms to EN 61204-3 Class A and FCC Class A.		
	Radiated EMI	Conforms to EN 61204-3 Class A.		
	Safety standards (pending)	cULus: UL508 (Listing, Class2: Per UL1310), CSA C22.2 No.107.1 (Class2: Per CSA C22.2 No.22.3) cURus: UL60950-1, CSA C22.2 No.60950-1 EN: EN50178, EN60950-1 VDE: VDE0160, VDE0805 Teil1		
	SEMI standard	SEMI F47-0706 (200 VAC input)		
Weight	2,400 g max.			

- *1. Do not use an inverter output for the Power Supply. Inverters with an output frequency of 50/60 Hz are available, but the rise in the internal temperature of the Power Supply may result in ignition or burning.
- *2. Refer to *Engineering Data* on page 8 for details.
- *3. If the output voltage adjuster (V. ADJ) is turned, the voltage will increase by more than 10% of the voltage adjustment range. When adjusting the output voltage, confirm the actual output voltage from the Power Supply and be sure that the load is not damaged. If the output voltage exceeds 28.8 V, all branch outputs will be cut off.
- *4. Rated input and output conditions: Rated input voltage, rated frequency, rated output voltage, rated total output current, and maximum cutoff output current.
- *5. 100% load conditions: Rated output voltage, rated total output current, and maximum cutoff output current.

Connections

Block Diagrams

S8AS-24006

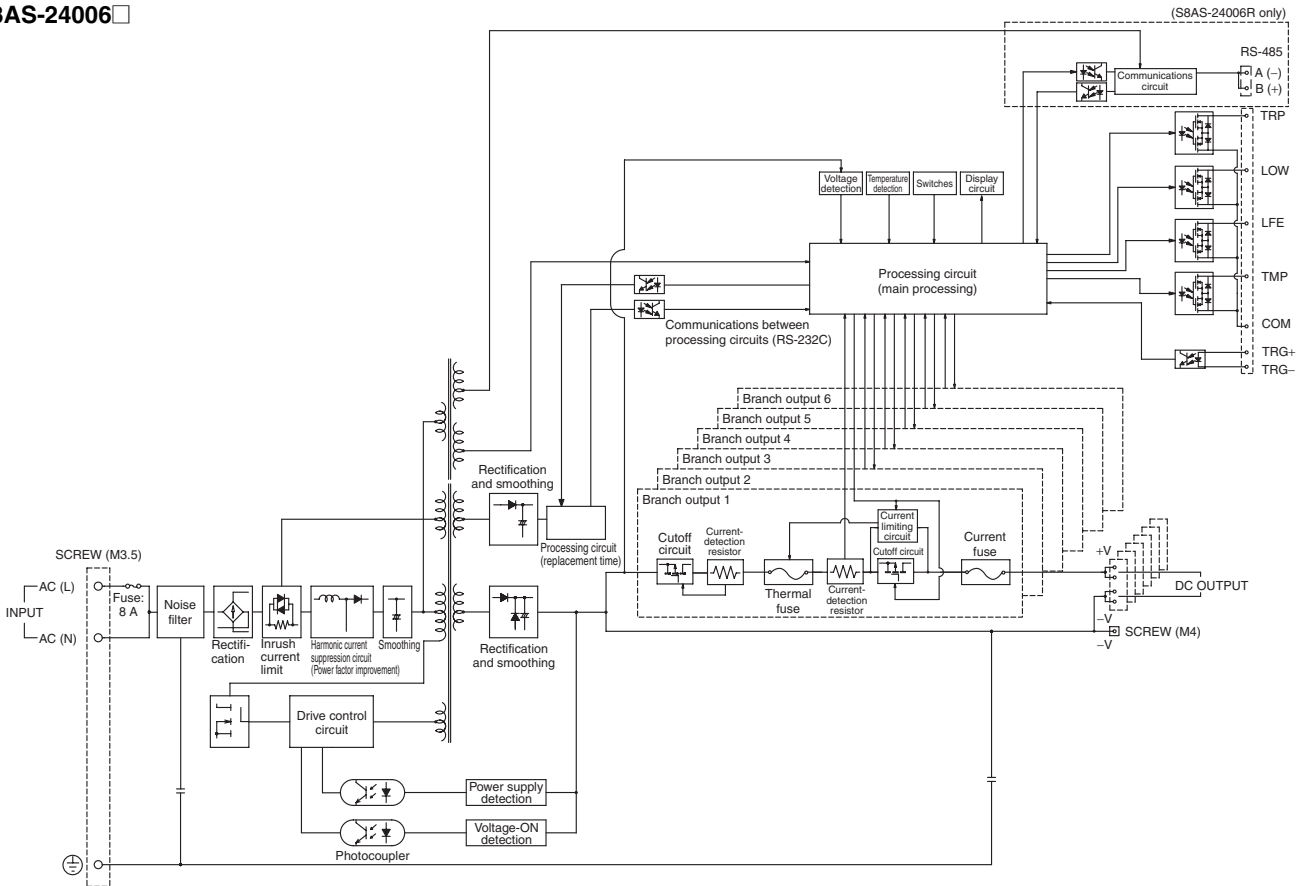

S8AS-48008

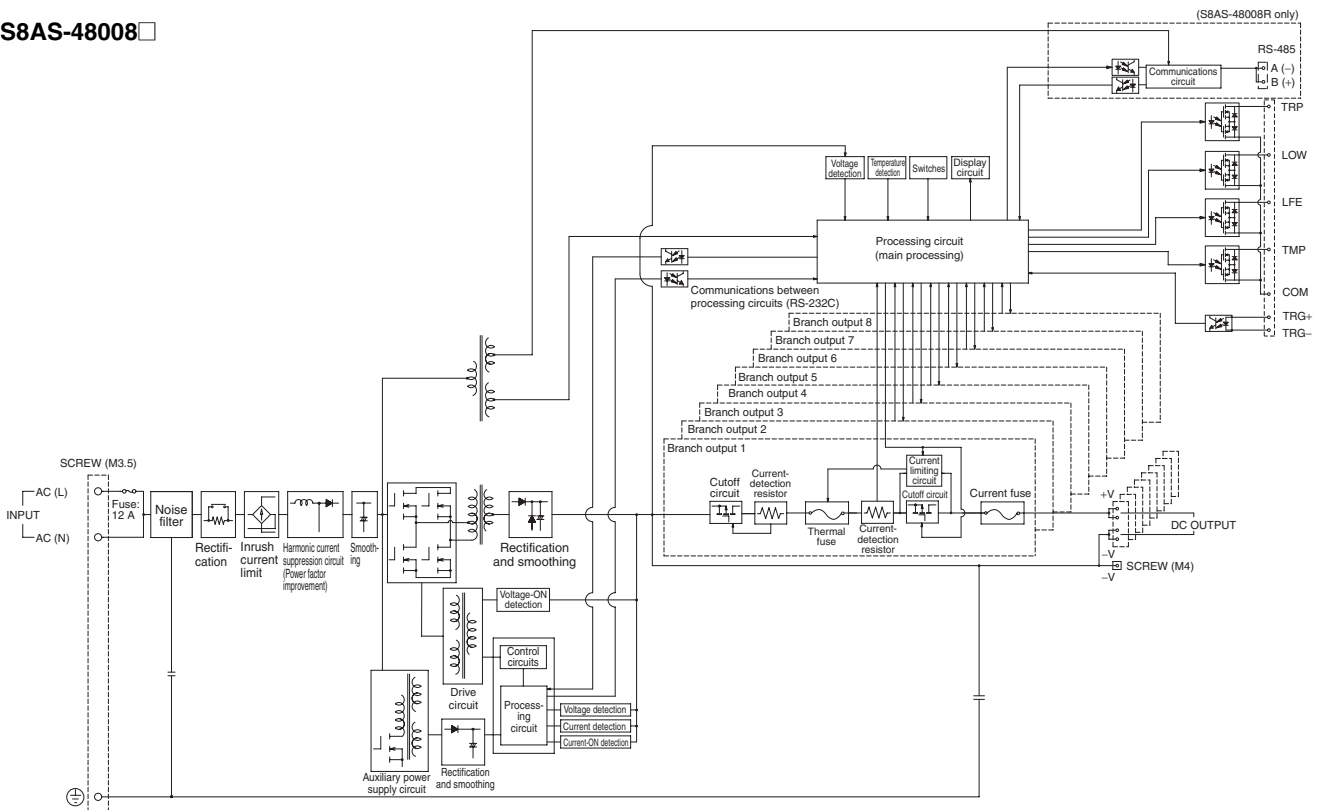

Constructions and Nomenclature

Nomenclature

S8AS-24006

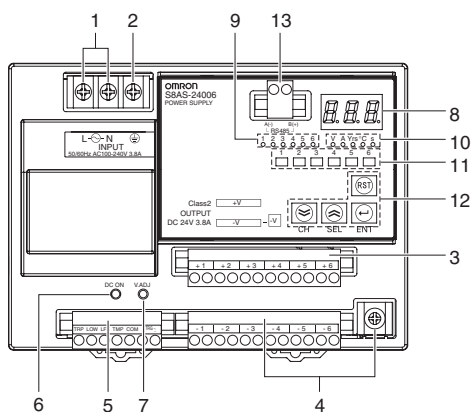

S8AS-48008

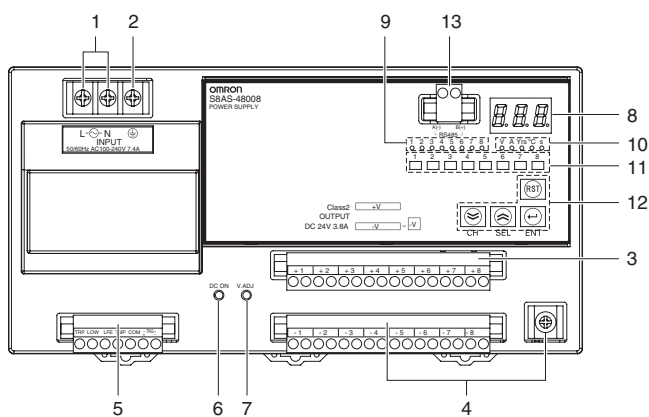

5. I/O Signal Terminal Internal Circuit Configuration

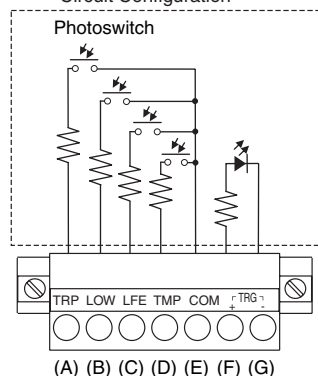

No.	Name	Functions	
1	AC Input Terminals (L and N)	Connects the input power supply (100 to 240 VAC, 50/60 Hz) (commercial power supply). *1	
2	Protective Earth (PE) Terminal (⊕)	Connects to the ground wire. *2	
3	Positive Branch Output Terminals (+)	Screwless terminals with 2-pole terminals for each branch output.	
4	Negative Branch Output Terminals (-)	Screwless terminals with 2-pole terminals for each branch output and screw terminal shared by the negative branch output terminals.	
5	I/O Signal Terminals	(A) Tripping Alarm Output (TRP) *3	Turns ON to indicate when an abnormal voltage or current was detected and the output was cut off. (The photoswitch output will turn OFF.)
		(B) Undervoltage Detection Output (LOW)	Turns ON to indicate when the 24-VDC output voltage of the S8AS falls below the threshold due to decrease in input voltage or other factors. (The photoswitch output will turn OFF.)
		(C) Maintenance Forecast Monitor Output (LFE)	Turns OFF to indicate when the number of years to the set replacement time has been reached. (The photoswitch output will turn OFF.)
		(D) Over-temperature Output (TMP)	Turns ON to indicate that the temperature exceeded the over-temperature output threshold. (The photoswitch output will turn OFF.)
		(E) Negative Common Terminal (COM) (no polarity)	Negative common shared by the four alarm outputs ((A) to (D)) above.
		(F) Positive External Tripping Input (TRG+)	Can be used to send an input signal from an external device to cut off a branch output. *4
		(G) Negative External Tripping Input (TRG-)	
6	Output Indicator (DC ON (Green))	Indicates whether there is output voltage supplied.	
7	Output Voltage Adjuster (V.ADJ)	Adjusts the output voltage.	
8	Seven-segment Display (Red)	Displays measured values or set values.	
9	Branch Output Indicators (Orange)	Light or flash when there is a display related to branch output (outputs 1 to 6 and 8). *5	
10	Unit Indicators (Orange)	Light or flash when there is a unit (e.g., V, A, Yrs, °C, s) related to the value shown on the 7-segment display.	
11	Status indicators (Red/Green)	Indicate the status of the branch outputs: Cutoff: red, Connected: green. *6	
12	Operation Keys	Reset (RST) Key	Used to clear the error status when a branch output was cut off by an error or there was an alarm output.
		Enter (ENT) Key	Used to switch the display item, enter or execute settings, etc.
		Up (SEL) Key	Used to change the display item forward or to increase a set value.
		Down (CH) Key	Used to switch the branch output or to decrease a set value. The branch output number that is set remains the same in other modes.
13	Communications Terminals (A (-), B (+)) (Only for Models That Support Communications)	Used to connect to the RS-485 communications line.	

Note: The noise value depends on the wiring method and other factors. Insert a clamp filter (recommended: E04SR301334 manufactured by SEIWA) on the communications wiring as a countermeasure against noise.

- *1. The fuse is located on the (L) side.
- *2. This is the protective earth terminal specified in the safety standards. Always ground this terminal.
- *3. In Test Mode, the tripping alarm output (TRP) will operate even if one or more of the branch outputs is set to OFF. This error output, however, will not be held when operation moves to another operating mode.
- *4. Wire the polarity of the external tripping input correctly. After completing wiring, confirm that the input operates correctly.
- *5. The branch output indicators are OFF when current is not used.
- *6. Information on procedures for detailed displays is given in *Status Indicators* on page 16.

Engineering Data

Derating Curve

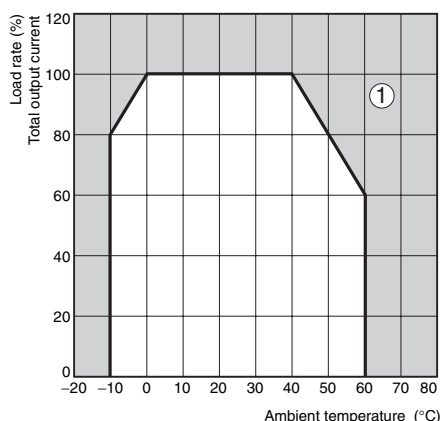

- Note: 1.** Internal parts may occasionally be deteriorated or damaged. Do not use the S8AS in areas outside the derating curve (i.e., in the area shown by shading ① in the above graph).
- 2.** Use forced cooling if necessary to satisfy the derating curve.
- 3.** For 480-W models, reduce the load to 80% or less for long-term use at an input voltage of 95 VAC or less.

Abnormal Current Tripping

Standard Detection

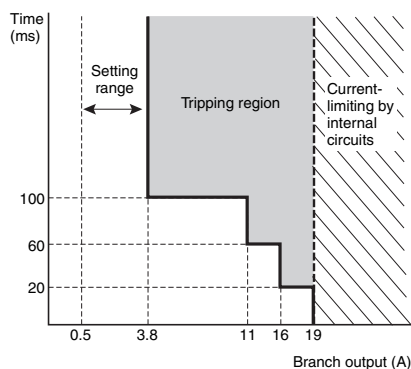

Instantaneous Detection

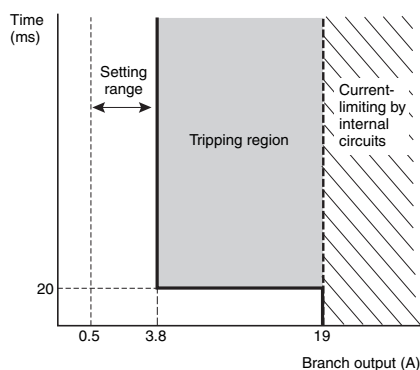

Extended Detection

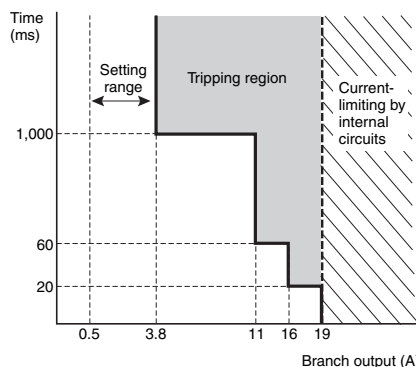

Tripping Performance

The S8AS detects the current of branch outputs as digital values and numeric processing is performed to execute cutoff operations. Refer to *Abnormal Current Tripping* for the tripping performance. The following cutoff functions are also provided.

Judgment Type Selection

Standard, instantaneous, or extended can be set as the method for detecting the tripping current. With the S8AS-24006N/48008N, only the extended detection is supported. Refer to the *S8AS User's Manual (Cat. No. Z269)* for the setting method.

Current Limit

This function is provided to limit excessive short currents, such as those that can flow for equipment short faults.

Startup Delay

This function is provided to disable cutoff operations for 40 ms after the branch outputs turn ON so that cutoff operations will not occur for large inrush currents.

Safety Circuits

Temperature fuses and current fuses are provided for each branch output to ensure safety even in the unusual event of an internal failure.

Mounting

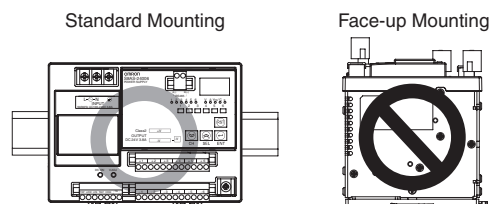

- Note: 1.** The above illustration shows a 240-W model.
- 2.** Poor heat dissipation resulting from improper installation conditions may occasionally deteriorate or damage internal parts and also cause the maintenance forecast monitor function to not operate properly. Do not use any mounting orientation other than a standard one.

Inrush Current, Startup Time, Output Hold Time

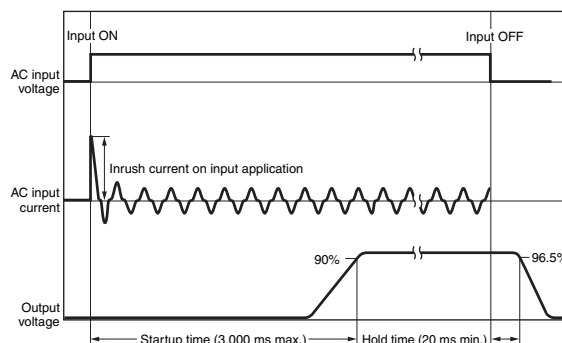

Functions

Functions

Alarm	Alarm output	Output status	Alarm display
Abnormal voltage tripping	TRP output: OFF (normally ON)	All branch outputs cut off.	A10
Abnormal current tripping	TRP output: OFF (normally ON)	Relevant branch output cut off.	A11
Abnormal total current tripping (240-W models only)	TRP output: OFF (normally ON)	All branch outputs cut off.	A12
Undervoltage detection	LOW output: OFF (normally ON)	ON	A21
Maintenance forecast monitor	LFE output: OFF (normally ON)	ON	A23
Overheating alarm	LFE output: OFF (normally ON)	ON	A23/HOT
Over-temperature	TMP output: OFF (normally ON)	ON	A30

Tripping Functions

Function	Operation
Abnormal voltage tripping Refer to Chart 1 . *1, *2, *3	The output voltage is monitored and all branch outputs are cut off if the detection voltage is reached. Notification of the status is provided using the alarm display and the tripping alarm output (TRP). The alarm display will alternate between the voltage and the alarm code (A10). Detection voltage: 28.8 V (fixed)
Abnormal current tripping Refer to Chart 2 . *1, *2	The output current is monitored and the branch output that is abnormal is cut off if the preset current is reached. Notification of the status is provided using the alarm display and the tripping alarm output (TRP). The alarm display will alternate between the current and the alarm code (A11). Setting range: 0.5 to 3.8 A (in 0.1-A increments). The S8AS-24006N and S8AS-48008N are set to 3.8 A. (Cannot be changed.) <u>One of the following three abnormal current tripping types can be set.</u> With the S8AS-24006N/48008N, only the standard detection is supported. Standard Detection: Tripping within 100 ms. (Abnormal current will be detected and the output will be cut off within 20 ms if current continuously exceeds the set value for more than 80 ms.) Instantaneous Detection: Tripping within 20 ms. (Abnormal current will be detected and the output will be cut off within 10 ms if current continuously exceeds the set value for more than 10 ms.) Extended Detection: Tripping within 1,000 ms. (Abnormal current will be detected and the output will be cut off within 20 ms if current continuously exceeds the set value for more than 980 ms.)
Abnormal total current tripping *1, *2	Using the abnormal total current tripping function, the S8AS monitors the total output current and when the total output current exceeds the set value, all branch outputs are cut off. Notification of the status is provided using the alarm display and the tripping alarm output (TRP). The error code A12 will be shown on the display. There are a number of conditions for the tripping current and time. If even one of these conditions is detected, the abnormal total current tripping function will be activated. 240 W: Branch outputs are cut off when the total output current is more than 17 A for 2 s, 15 A for 5 s, 13 A for 10 s, or 12 A for 20 s. 480 W: Branch outputs are cut off when the total output current is more than 27 A for 1 s, 25 A for 2 s, or 22.5 A for 5 s.
External tripping input *1	The output can be cut off by inputting a voltage to the external tripping input (TRG terminal). If a shutdown sequence has been set, outputs will be cut off according to the shutdown sequence. Each branch output can be enabled or disabled individually. On the S8AS-24006N/S8AS-48008N, all branch outputs are enabled. (Cannot be changed.) External input signal width: 10 ms min. Input signal levels High level: 19.2 to 30 VDC Low level: 0 to 2.5 VDC Tripping can also be performed by using communications (S8AS-24006R/S8AS-48008R only). Refer to the <i>S8AS User's Manual (Cat. No. Z269)</i> for information on tripping using communications.

Note: Three abnormal current tripping types with different tripping current characteristics are supported: standard detection, instantaneous detection, and extended detection. Select the required tripping type.

*1. Outputs are cut off using semiconductor relays and electrical insulation is not provided.

*2. With the default settings, the alarm display and alarm output can be cleared using one of the following methods.

- Clear using the reset operation.
- Clear by turning the supply power OFF and ON again.

*3. The voltage detection is performed on the voltage after AC/DC conversion in the internal circuits. The displayed voltage will be somewhat different from the value at the output terminals of the power source due to internal voltage drop. To confirm correct output voltages, measure the voltages at the branch output terminals.

Chart 1: Operation Timing

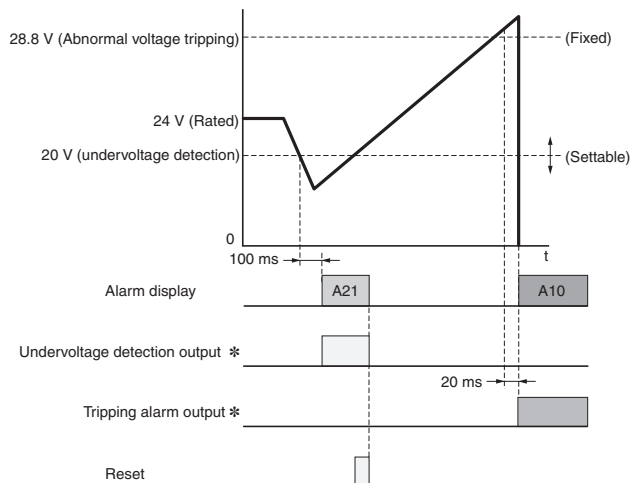

* The undervoltage detection output and tripping alarm output are both photoswitch outputs. The output is normally ON and turns OFF when an alarm is detected.

Chart 2: Operation Timing

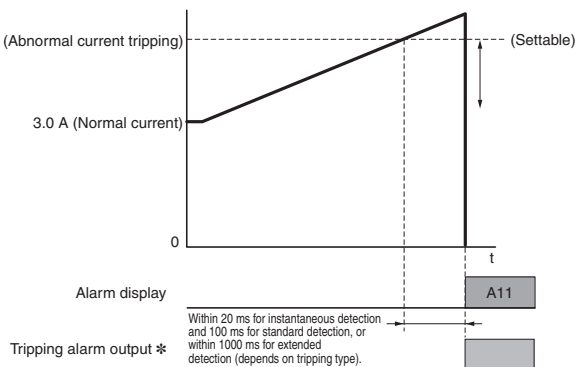

* The tripping alarm output is a photoswitch output. The output is normally ON and turns OFF when an alarm is detected.

Alarm Functions

Function	Operation
Undervoltage detection output (Refer to Chart 1.) *1, *2	The voltage is monitored and notification is provided using the alarm display and output (LOW) if the preset voltage is exceeded for more than 80 ms. The alarm display will alternate between the voltage and the alarm code (A21). Undervoltage detection threshold setting range: 18.0 to 26.4 V in 0.1-V increments. The S8AS-24006N and S8AS-48008N are set to 20.0 V. (Cannot be changed.)
Maintenance forecast monitor *1	The time that the power is ON is calculated as the S8AS run time and notification is provided using the alarm display and maintenance forecast monitor output (LFE) if the preset time is reached. The alarm display will alternate between the run time and the alarm code (A23). Display range: FUL (Full), HLF (Half), or 0.0 to 5.0 years.
Over-temperature (Refer to Chart 3.) *1	The internal temperature of the S8AS is monitored using a built-in temperature sensor and notification is provided using the alarm display and over-temperature output (TMP) if the preset temperature is exceeded for more than 1 s. The alarm display will alternate between the temperature and the alarm code (A30). The over-temperature output is convenient for control operations, such as operating a cooling fan to suppress temperature increased in the control panel. Note: The alarm display and over-temperature output are automatically cleared if the temperature falls below the set temperature. Display range: -20 to 100°C in 1°C increments. Temperature setting range: 25 to 90°C in 1°C increments.

- Note: 1.** Branch outputs are not cut off for the alarm functions
2. The voltage detection is performed on the voltage after AC/DC conversion in the interval circuits. The displayed voltage will be somewhat different from the value at the output terminals of the power source due to internal voltage drop. To confirm correct output voltages, measure the voltages at the branch output terminals.

Chart 3: Operation Timing

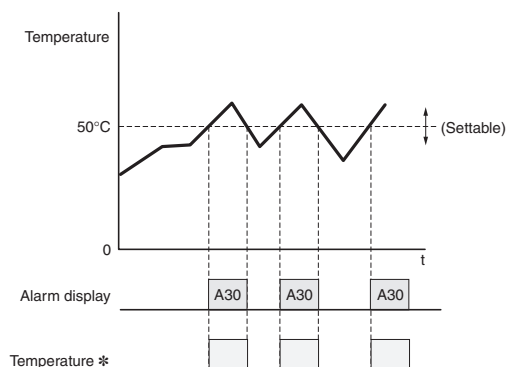

* The alarm display and over-temperature output are automatically cleared (with hysteresis). The over-temperature output is a photoswitch output. It is normally ON and turns OFF when an alarm is detected.

Maintenance Forecast Monitor Function

Indication and Output

When the Product is purchased, "FUL" will be displayed. As the electrolytic capacitors deteriorate, the display will change to "HLF" (Refer to *Maintenance Forecast Monitor Function*). "FUL" will be displayed for the maintenance forecast display for approximately one month after the Power Supply is first turned ON. The accumulated value will then be displayed depending on the ambient conditions. (However, the "HLF" display may not appear, depending on the application environment and the set value for maintenance forecast.) If the maintenance forecast setting L (which can be set to 0.0 to 5.0 years in 0.5-year increments) is set to a value larger than two years, the display automatically changes to a value (L - 0.5) after the remaining time to maintenance is reduced to the set number of years, and an alarm (A23) and the remaining time will be displayed alternately.

If the setting is less than 2.0 years, the display changes to a value (1.5) after the remaining time becomes less than two years, and after the remaining time becomes less than the set time, an alarm (A23) and the remaining time (L - 0.5) will be displayed alternately.

If the alarm (A23) and a numeric value are displayed alternately, the transistor (maintenance forecast output terminal (Yrs)) will turn OFF to indicate the need for maintenance., i.e., there will be no continuity at the maintenance forecast output terminals.

(The LEF output will turn OFF when the maintenance time has been reached.)

Example: Display When the Time Remaining to the Maintenance Time Is Less Than 0.5 yr

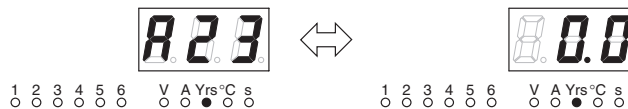

- Note: 1.** The time remaining to maintenance is based on continuous operation, not including the time when the power supply is turned OFF.
- 2.** "FUL" will be displayed until approximately one month of time has passed to enable estimating the speed of deterioration. The output will remain ON (i.e., there will be continuity at the maintenance forecast output terminal (Yrs)).
- 3.** For details on the display, refer to *Relationship between Displayed Values and Output of Set Values*.

Maintenance Forecast Monitor Function

The Power Supply is equipped with electrolytic capacitors. The electrolyte inside the electrolytic capacitors penetrates the sealing rubber and evaporates as time passes after it is manufactured. This causes deterioration of characteristics, such as decreasing the capacitance. Due to this deterioration of the characteristics of the electrolytic capacitor, the Power Supply decreases its performance as time passes.

The maintenance forecast monitor function shows an approximate period left for maintenance of the Power Supply due to deterioration of electrolytic capacitors. When the period left for maintenance that the power supply forecasts reaches the set value, an alarm is indicated and an output signal is triggered. Use this function to know the approximate replacement timing of the Power Supply.

Note: The maintenance forecast monitor function indicates an approximate period left for maintenance, based on deterioration of the electrolytic capacitors. It does not predict failures resulting from other causes.

Relationship between Displayed Values and Output of Set Values

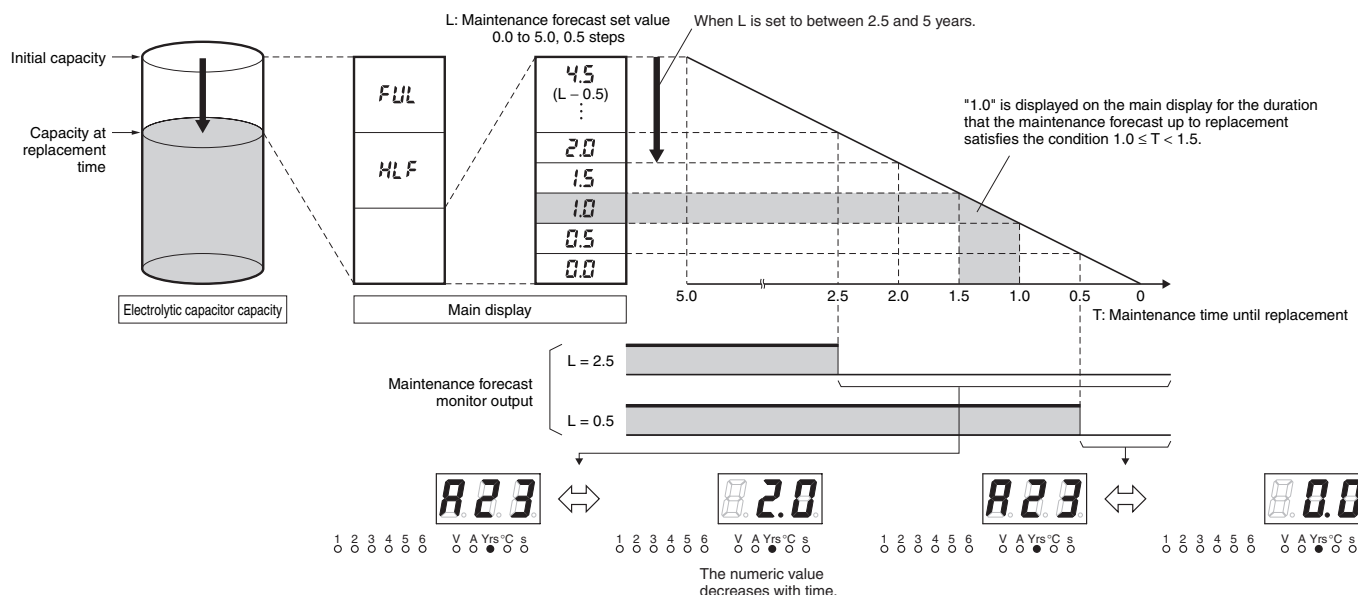

Principle of Operation

The deterioration speed of the electrolytic capacitors varies considerably with the ambient temperature. (Generally the speed follows the Arrhenius Law, i.e., for every 10°C increase in the temperature, the rate of degradation doubles.) The S8AS monitors the temperature inside the Power Supply, and calculates the amount of deterioration according to the operating hours and internal temperature.

Based on this amount of deterioration, the Power Supply will provide an alarm indication and output when the period left for maintenance reaches the set value.

- Note: 1.** Due to degradation of internal electronic parts, replace the Power Supply approximately 15 years after purchase even if the maintenance forecast monitor indication and output do not appear.
- 2.** The maintenance forecast is accelerated or decelerated according to operating conditions. Periodically check the display.
- 3.** Acceleration or deceleration of the maintenance forecast may cause the output to repeatedly go ON and OFF.
- 4.** The accuracy of the maintenance forecast function may be adversely affected by applications in which the AC input is frequently turned ON and OFF.

Difference between Expected Life and Replacement Time

OMRON calculates the expected life based on the following conditions.

1. Rated input voltage
2. Load rate: 50%
3. Ambient temperature: 40°C
4. Standard Mounting

Note: The expected life is calculated by performing a temperature rise test using an aluminum electrolytic capacitor, and therefore is not a guaranteed value.

The expected life span of the S8AS is 10 years.

The maintenance forecast is the service life (the Power Supply's internal temperature is monitored at all times) of the internal electrolytic capacitors in actual operating conditions, and depends on the customer's operating conditions. The maximum period of the maintenance forecast is taken as 15 years.

Other Functions

Function	Operation
Startup sequence (Refer to Chart 5 .)	The connection timing for branch outputs 1 to 6 and 8 can be set individually to offset the connection timing to the load devices. Creating time delays between starting loads enables safer load operation. It also reduces total inrush current so that power supply capacity can be optimized. Setting range: 0.0 to 99.9 s in 0.1-s increments. For the S8AS-24006N and S8AS-48008N, the settings are 0.0 s for branch output 1, 0.4 s for branch output 2, 0.8 s for branch output 3, 1.2 s for branch output 4, 1.6 s for branch output 5, 2.0 for branch output 6, 2.4 s for branch output 7, and 2.8 s for branch output 8. (Cannot be changed.) *
Shutdown sequence (Refer to Chart 6 .)	The cutoff timing for branch outputs 1 to 6 and 8 can be set individually to offset the cutoff timing of load devices for the external tipping input or to enable an emergency stop. Setting range: 0.0 to 99.0 s in 0.1-s increments. For the S8AS-24006N and S8AS-48008N, all branch outputs have a setting of 0.0 s. (Cannot be changed.) *
Startup Delay	A delay function is provided so that the abnormal current tripping function or overcurrent alarm function will not be triggered by large initial inrush currents, e.g., for capacitive loads or lamp loads. The abnormal current tripping function will function once the set time has elapsed. (Note: The delay is 40 ms and cannot be changed.)

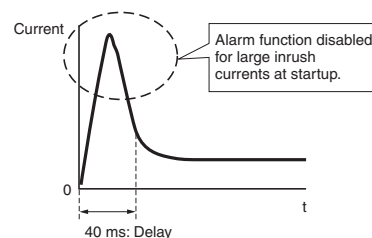

* The sequencing functions are designed for the six branch outputs of one S8AS. There is no synchronization processing between S8AS Power Supplies when more than one S8AS is used. Sequencing functions for branch outputs 7 and 8 are available only with the S8AS-48008N.

Chart 5: Operation Timing

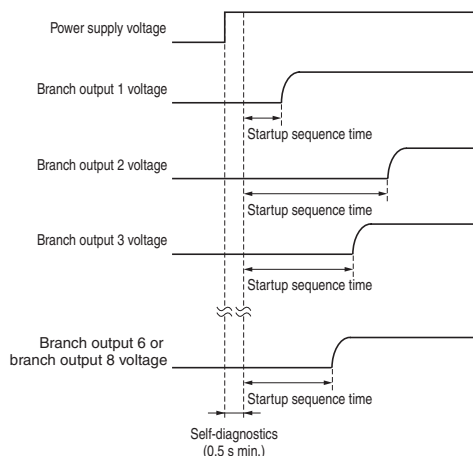

Note: For the S8AS-24006N and S8AS-48008N, the settings are 0.0 s for branch output 1, 0.4 s for branch output 2, 0.8 s for branch output 3, 1.2 s for branch output 4, 1.6 s for branch output 5, 2.0 s for branch output 6, 2.4 s for branch output 7, and 2.8 s for branch output 8. (Cannot be changed.) (Branch outputs 7 and 8 are available only with the S8AS-48008N.)

Chart 6: Operation Timing

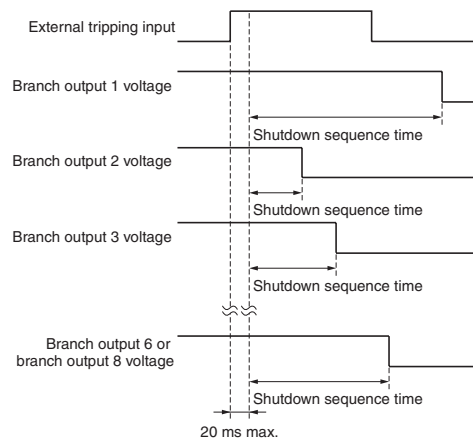

- Note: 1.** Cut off simultaneously for tripping for abnormal voltages (28.8 V or higher).
- 2.** For the S8AS-24006N and S8AS-48008N, all branch outputs have a setting of 0.0 s. (Cannot be changed.)

Key Operations and Displays in Each Mode

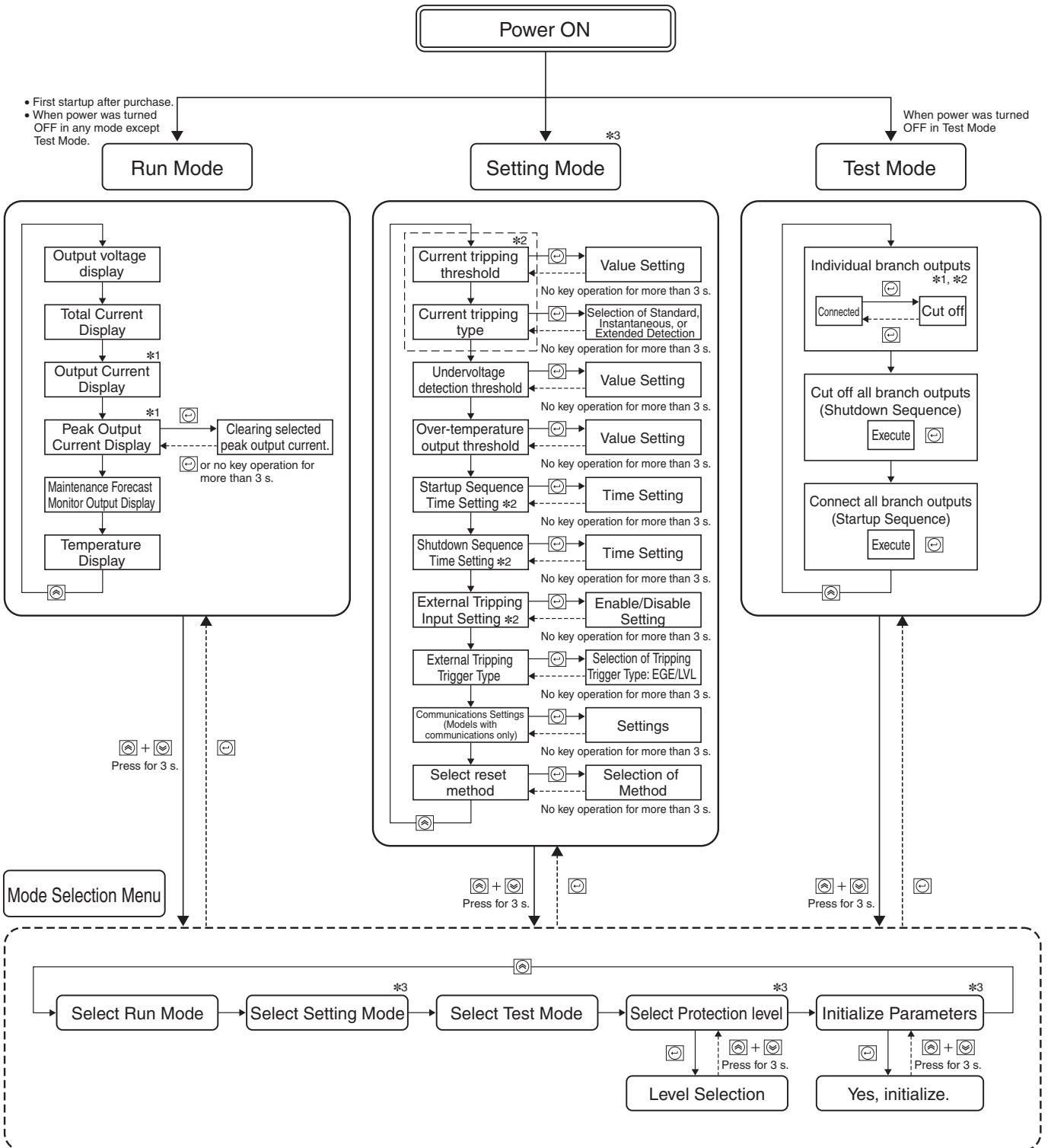

*1. Branch outputs can be changed using the Down (⏴) Key. The changes to the branch outputs will be retained in other displays as well.
 *2. Settings are displayed in order for branch outputs. Specific branch output settings have been omitted.
 *3. Not displayed for the S8AS-24006N/48008N.

Mode Descriptions

The S8AS supports a Run Mode, Setting Mode, and Test Mode.

Run Mode	Used for normal operation. The measurements for the output voltage, output current, replacement time, and internal temperature can be read on the seven-segment display.
Setting Mode *	Used to set or change S8AS parameters.
Test Mode	Used to test operation for devices connected to the S8AS.

Note: Refer to the *S8AS User's Manual* (Cat. No. Z269) for details.
 * The S8AS-24006N and S8AS-48008N do not have a Setting Mode.

Initial Setting Procedure after Purchase

The following diagram illustrates mode transitions for the S8AS. When the S8AS is turned ON for the first time, it will enter Setting Mode. After changing to Setting Mode, set the initial setting for each parameter, and then switch to Test Mode or Run Mode.

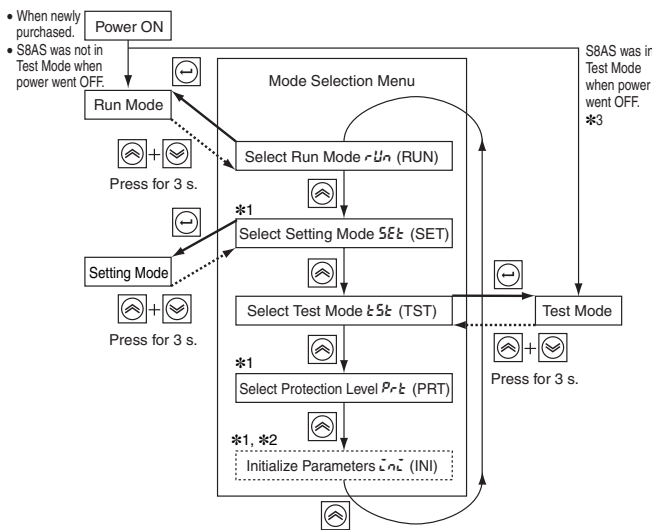

*1. Not displayed for the S8AS-24006N/48008N.
 *2. Initialize Parameters is displayed only in protection level 0.
 *3. If the Mode Selection Menu is entered in Test Mode and then the power is turned OFF before entering another operating mode, the S8AS will start in Test Mode the next time it is started.

Mode Selection Menu

- (1) Run Mode (RUN)**
 (1) In Run Mode, the current for each branch output, the total output current, the output voltage, the replacement time, the internal temperature, and other values can be displayed. Use this mode for operation once initial settings and system adjustments have been completed.
 - (2) Setting Mode (SET)**
 (2) Setting Mode is used to set parameters.
 - (3) Test Mode (TST)**
 (3) Test Mode enables forcing branch outputs ON and OFF. Connections and cutoffs can be manipulated for all outputs for each branch output. By default, all outputs will be ON (connected). Use this mode to set unused branch outputs to OFF (not connected).
 - (4) Protection Level (PRT)**
 (4) Protection Level can be used to set restrictions for setting parameters. Three levels, levels 0, 1, and 2, are available. The default is level 1. Refer to the User's Manual for the parameters that are protected in each level.
 - (5) Initialize Parameters (INI)**
 (5) Parameters can be initialized to return all parameters to their default settings. The Initialize Parameters is not displayed in the default protection level (level 1).
- ((1) Switches to RUN Mode display.)

Go to Setting Mode to change any of the default parameter settings. Operation may be restricted by the protection level, preventing changes to some parameters. If necessary, change the protection level.

Refer to the *User's Manual* for details on parameters and restrictions for the protection levels.

Run Mode

Run Mode is used for normal operation. When the power is turned ON and the mode was Run Mode or Setting Mode the last time the input power was turned OFF, the S8AS will start in Run Mode and connecting the branch outputs will be started. Monitoring of voltages, currents, replacement time, and temperature can be confirmed using the Up Key and Down Key (▲/▼).

(1) Output Voltage 

1 2 3 4 5 6 V A Yrs °C s

(2) Total Output Current 

1 2 3 4 5 6 V A Yrs °C s

(3) Present Output Current for Branch Output 1 *1 

1 2 3 4 5 6 V A Yrs °C s

(Select the branch output with the Down (CH) Key.)

(4) Peak Current for Branch Output 2 

1 2 3 4 5 6 V A Yrs °C s

(Select the branch output with the Down (CH) Key.)

(5) Replacement Time 

1 2 3 4 5 6 V A Yrs °C s

(6) Internal Temperature 

1 2 3 4 5 6 V A Yrs °C s

(1) Switches to output voltage display.)

(1) When Run Mode is entered, the parameter that was displayed the last time Run Mode was used will be displayed. The voltage output display is shown at the left as an example.

(2) The total current for all outputs is displayed.

(3) The output current of the last branch output that was set will be displayed regardless of the operating mode. The current output of the branch output 1 is shown at the left.

The current output of the branch output 2 is shown by pressing the Down (CH) Key. *The branch output number set with the Down (CH) Key is stored in memory even when the operating mode or parameters are changed. The branch output displayed when Test Mode is entered will not necessarily be branch output 1.

(4) Press the Up (SEL) Key to display the peak current for the branch output displayed in step 2 (e.g., branch output 2). The "A" unit indicator will flash while the peak current is being displayed. The peak current can be cleared by performing the following procedure while the peak current is being displayed.

1. Press the ENT Key.
2. Change the "NO" display to the "YES" display using the Up (SEL) Key.
3. Press the ENT Key again.

(5) Displays the estimated number of years until the replacement time.

(6) Displays the internal temperature.

Press the Up (SEL) Key again to return to the output voltage display and start the display cycle again.

Status Indicators

The status indicators light according to the branch output status as described below.

Lit green	Normal connection status
Flashing green	Connection standby status during the startup sequence
Lit red	Cutoff status for an abnormality
Flashing red	Cutoff status for an internal abnormality
Not lit	Forced cutoff or operation stopped

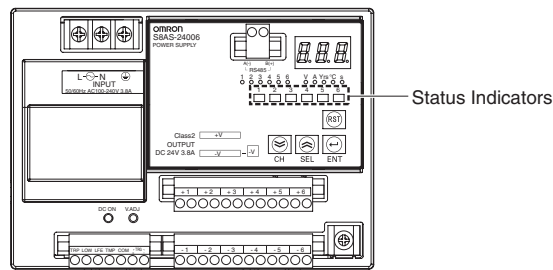

Clearing the Peak Output Currents

The peak output currents can be cleared. Select the peak output current to be cleared in Run Mode and then use the following operation.

Peak Output Current Display



1 2 3 4 5 6 V A Yrs °C s

Waiting display, 1 s



1 2 3 4 5 6 V A Yrs °C s

← or 3 s with no key operations

Clearing completed.



1 2 3 4 5 6 V A Yrs °C s

Set value saved (flashes for 3 s)



1 2 3 4 5 6 V A Yrs °C s

After flashing for 3 s

Indicator Status Notation

● Lit ● Flashing

- Note:**
1. The S8AS will start in Run Mode when power is turned ON for the first time after shipping from the factory.
 2. Settings cannot be changed in Run Mode. Use Setting Mode to change settings. (The setting for the S8AS-24006N and S8AS-48008N can not be changed.)
 3. If a startup sequence has been set, connections will be started according to the set delays.
 4. When moving to Run Mode, the branch output ON/OFF status from before entering Run Mode will be maintained. After testing branch output operation in Test Mode, always turn ON the required branch outputs before moving to Run Mode.
 5. The voltage detection function monitors the voltage at the power input terminals. Measure the voltage at the branch output terminals to confirm that the output voltage is correct.

Setting Mode

Setting Mode is used to set S8AS parameters. Settings can be read or changed while operation continues. The various parameters can be selected as shown below.

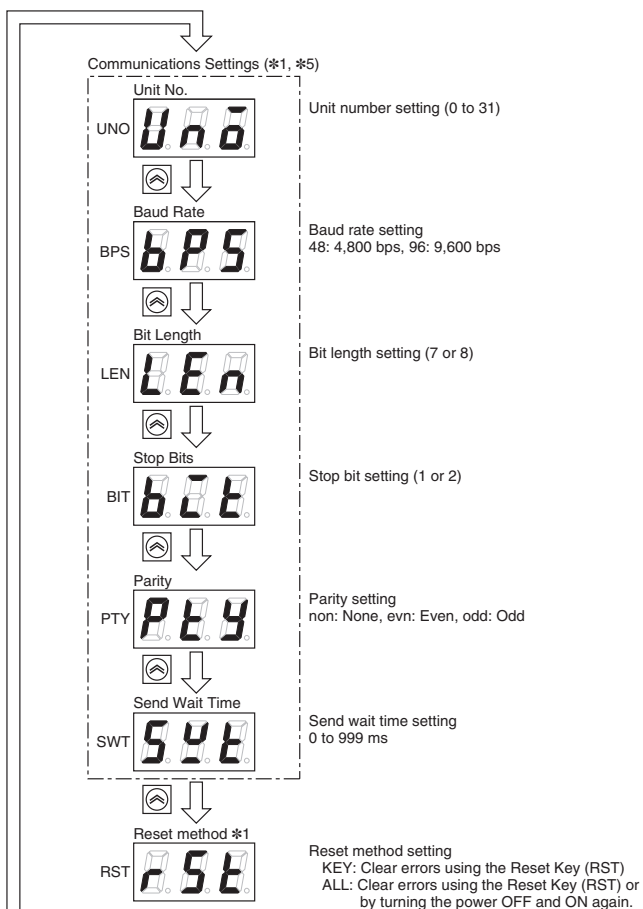
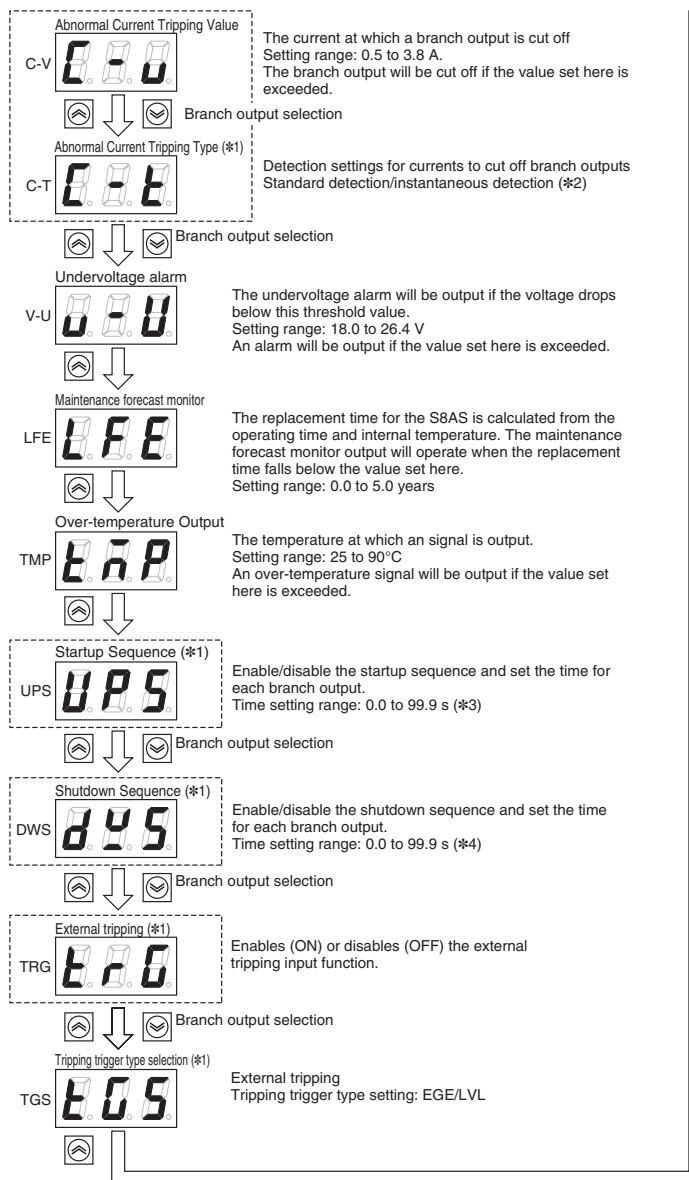

- Note:**
- Parameters cannot be changed in protection level 2, or when using the S8AS-24006N or S8AS-48008N.
 - The S8AS will start in Run Mode when power is turned ON for the first time after shipping from the factory.
 - Refer to the *S8AS User's Manual (Cat. No. Z269)*, when having further settings.

- *1. Not displayed in protection level 1 or 2.
- *2. The S8AS-24006N and S8AS-48008N use Extended Detection. (Cannot be changed.)
- *3. The S8AS-24006N and S8AS-48008N use a startup sequence using an offset of 0.4 s starting with the first branch output. (Cannot be changed.)
- *4. The shutdown sequence shutdown delay on the S8AS-24006N and S8AS-48008N is set at 0.0 s. (Cannot be changed.)
- *5. Communications settings will not be displayed on models that do not have communications functions.

Setting Parameters

Parameters are set as shown below.

Example for Setting the Abnormal Current Tripping Value

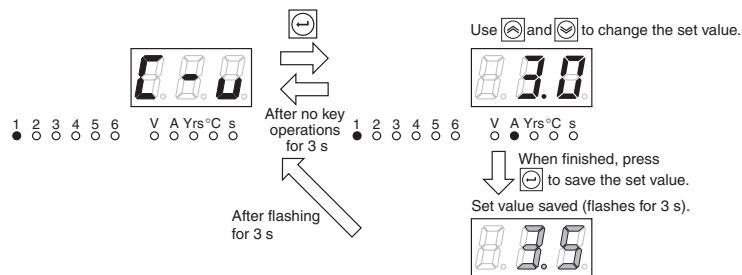

Indicator Status Notation

● Lit ○ Flashing

Test Mode

Device startup operation can be tested by turning ON/OFF branch outputs either individually or together. The branch outputs that are to be used are set to be connected in Test Mode. The operation to turn all branch outputs ON/OFF together can be used to check startup and shutdown sequences.

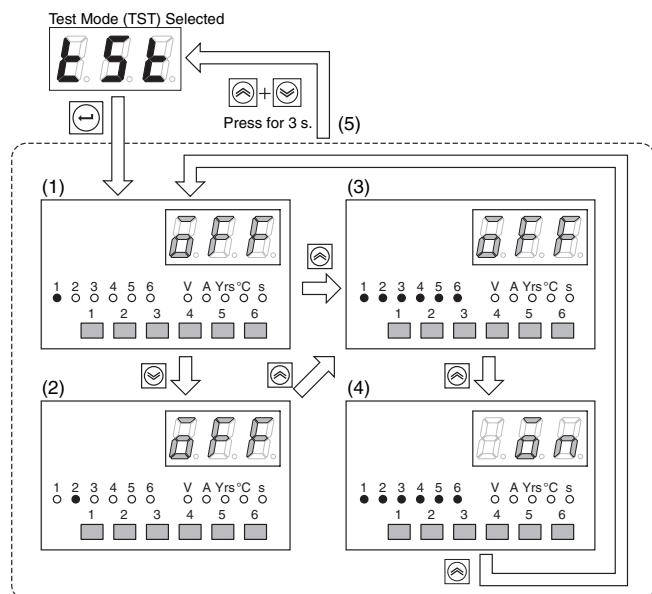

- Select TST (Test Mode) from the Mode Selection Menu and press the ENT Key. Test Mode will be entered.
- When Test Mode is entered, the branch output number 1 indicator (see note) will flash and "OFF" or "ON" will flash on the 7-segment display.
OFF flashing: Press the ENT Key to turn OFF branch output 1.
ON flashing: Press the ENT Key to turn ON branch output 1.
 - The branch output can be selected at display (1) by using the Down (CH) Key. Press the ENT Key to turn the output ON and OFF.
 - If the Up (SEL) Key is pressed at display (1), all branch output number indicators will flash and "OFF" will flash on the 7-segment display. All branch outputs can be turned OFF in this condition.
Press the ENT Key to turn all branch outputs OFF.
 - If the Up (SEL) Key is pressed at display (3), all branch output number indicators will flash and "ON" will flash on the 7-segment display. All branch outputs can be turned ON in this condition.
Press the ENT Key to turn all branch outputs ON.
 - After completing ON/OFF testing and setting the branch outputs, press the Up (SEL) and Down (CH) Keys simultaneously for 3 s to go to the Mode Select Menu, and then enter Run Mode.

* The branch output number set with the Down (CH) Key will not change even when the operating mode or parameters are changed. The branch output displayed when Test Mode is entered will not necessarily be branch output 1.

- Note: 1.** In Test Mode, the branch output number indicators and 7-segment display will continue to flash.
- Note: 2.** In Test Mode, the abnormal tripping output (TRP) will operate if one or more of the branch outputs are not connected. The TRP output will not operate if the operating mode is changed.
- Note: 3.** If power is turned OFF in Test Mode, Test Mode will be entered the next time power is turned ON.

Indicator Status Notation	
● Lit	○ Flashing

Protection Level Setting

A protection level can be set to prevent operating errors during normal operation. Reading or changing parameter settings and other operations can be restricted in three levels.

Protection Level	Intended for	Possible operations
0	Facility designers and manufacturers	All settings can be read and changed.
1	Facility maintenance personnel	Some settings can be read and changed.
2	On-site operators	Settings can be read but not changed.

Select PRT (protection level) from the Mode Selection Menu and then perform the following procedure. (The following example shows changing to protection level 0.)

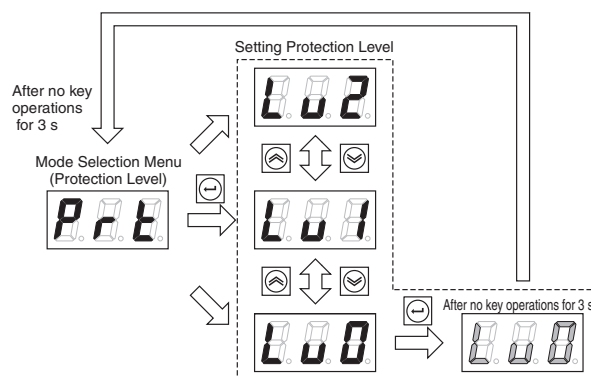

Parameter Initialization

All S8AS parameters can be restored to their default settings. Set protection level 0 and then go to the Mode Selection Menu. INI (parameter initialization) will be added to the menu. Select INI and then perform the following procedure.

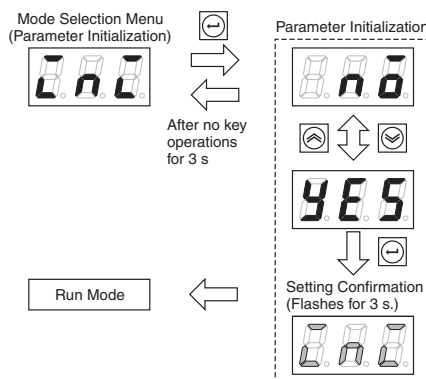

- Note: 1.** The Mode Selection Menu is not displayed in protection level 1 or 2. The default setting is for protection level 1.
- Note: 2. Default Settings**
- The operating mode will change to Run Mode.
 - The parameters will change to their default settings.
 - All branch outputs will be changed so they are connected.
 - The protection level will change to level 1.

List of Alarms

Alarm display	Name	Alarm outputs	Power outputs	Recovery/reset method
A10	Abnormal voltage tripping	TRP output: OFF (normally ON)	Total current tripping	Remove the cause of the abnormality and then press the Reset Key (RST) on the front panel or use communications reset function (S8AS-24006R and S8AS-48008R only). * Power supply will be restarted after recovery. Note: Once an error has been reset, another reset operation cannot be performed for at least 15 seconds.
A11	Abnormal current tripping	TRP output: OFF (normally ON)	Cut off	Remove the cause of the abnormality and then press the Reset Key (RST) on the front panel or use communications reset function (S8AS-24006R and S8AS-48008R only). * Power supply will be restarted after recovery. Note: Once an error has been reset, another reset operation cannot be performed for at least 15 seconds.
A12	Abnormal total current tripping	TRP output: OFF (normally ON)	Total current tripping	Remove the cause of the abnormality and then press the Reset Key (RST) on the front panel or use communications reset function (S8AS-24006R and S8AS-48008R only). * Note: Once an error has been reset, another reset operation cannot be performed for at least 15 seconds.
A21	Undervoltage alarm	ALM output: OFF (normally ON)	ON	Remove the cause of the abnormality and then press the Reset Key (RST) on the front panel or use communications reset function (S8AS-24006R and S8AS-48008R only). * Note: 1. Once an error has been reset, another reset operation cannot be performed for at least 15 seconds. 2. The alarm status will be reset if the cause of the alarm has been removed when the power supply is reset.
A23	Maintenance forecast monitor output	LEF output: OFF (normally ON)	ON	The replacement time specified for the S8AS has become less than the value set for the maintenance forecast monitor function. Either replace the S8AS or change the set value.
A23/HOT	Overheating alarm	LFE output: OFF (normally ON)	ON	Take steps to reduce the internal temperature of the S8AS. The error will automatically be cleared when the temperature becomes stable. However, if the overheating alarm stays ON for more than 3 hours, it can no longer be cleared. Be sure to clear the error within 3 hours.
A30	Over-temperature output	TMP output: OFF (normally ON)	ON	The alarm display and over-temperature output will automatically be reset if the temperature remains below the set value minus 3°C for at least 5 s.

Note: Alarms will be displayed in order of priority if more than one alarm occurs at the same time.

Order of priority: A10, A12, A11, A23/HOT, A21, A23, A30.

* Enabling or disabling the functionality to reset errors by turning the power supply OFF and then ON can be set using the Reset Method Setting (RST) parameter. However, the settings for the S8AS-24006N and S8AS-48008N cannot be changed.
(Initial setting: Errors can be reset by turning the power supply OFF and ON again.)

Alarm Display

The S8AS displays alarms according to the parameters set in Setting Mode. The alarm number and detected value are alternated on the display for each alarm.

Example: Abnormal Current Tripping Alarm at Branch Output 4

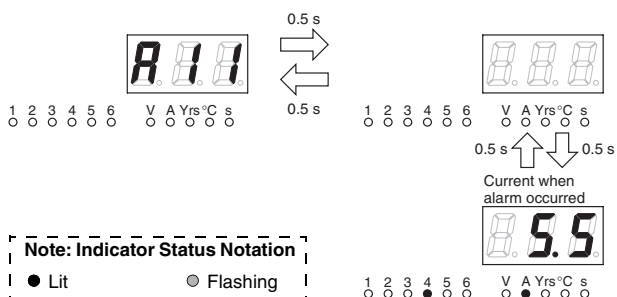

Note: Indicator Status Notation
 ● Lit ● Flashing

Note: Alarms will be displayed in order of priority if more than one alarm occurs at the same time.
 Order of priority: A10, A12, A11, A23/HOT, A21, A23, A30.

Resetting Alarms

When an alarm is displayed, remove the cause of the alarm and then press the Reset Key (RST) for at least 3 s.

The following display will appear and the alarm will be reset.
 For information on resetting alarms, refer to *List of Alarms* on the previous page.



Communications (S8AS-24006R/48008R)

The built-in RS-485 port can be used to connect special Support Tool to set parameters, monitor, perform tripping operations for branch outputs, and perform other remote monitoring and control operations from a network.

Type	RS-485
Communications method	Half-duplex
Sync method	Start-stop
Baud rate	4,800 or 9,600 bps
Transmitted code	ASCII
Data bit length	7 or 8 bits
Stop bit length	1 or 2 bits
Error detection	Vertical parity and BCC
Parity check	None, even, or odd
Protocol	CompoWay/F

Support Tool (S8AS-24006R/48008R)

The Support Tool is used to set and monitor models that support communications. Parameters can be set, operation can be monitored, and parameter files can be managed.

Support Tool Functions

- Reading and writing parameter settings
- Monitoring present values
- Monitoring status (cutoff status, normal/error status)

Applicable OS: Windows 2000 or XP

Visit OMRON's website for downloading the Support Tool.

Dimensions

S8AS Smart Power Supplies

S8AS-24006
S8AS-24006N

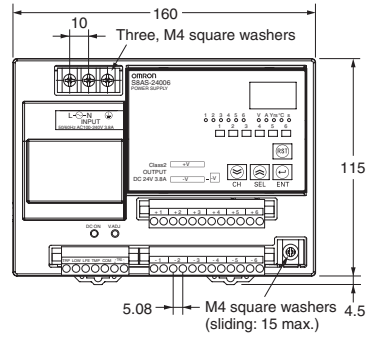
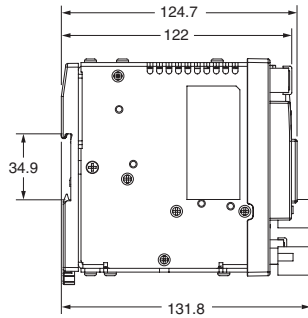

S8AS-24006R

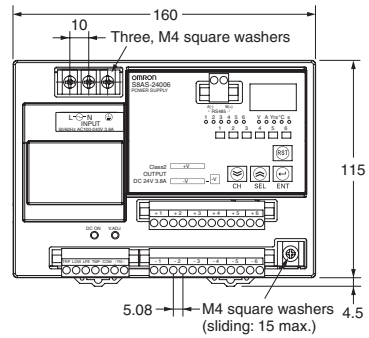
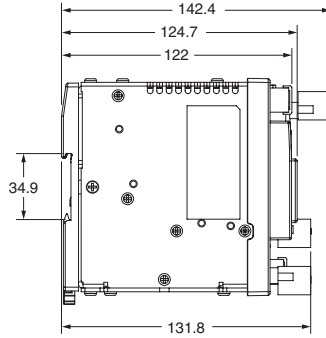

S8AS-48008
S8AS-48008N

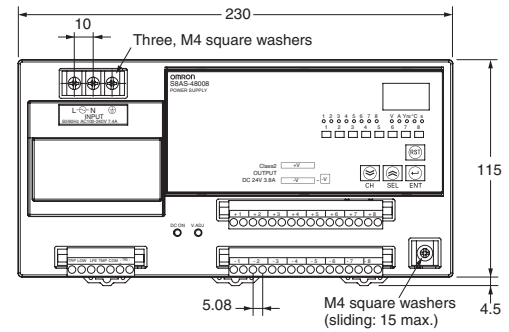
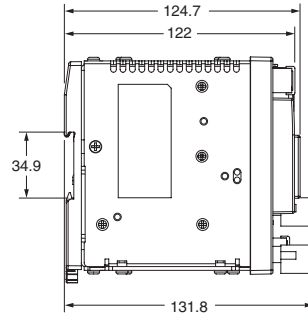

S8AS-48008R

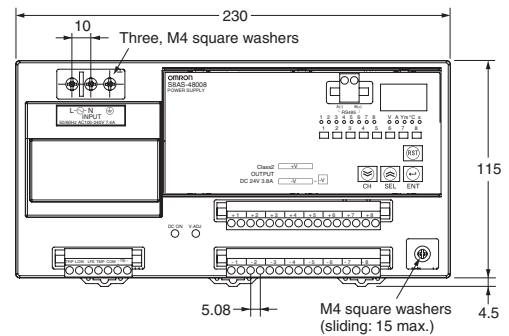
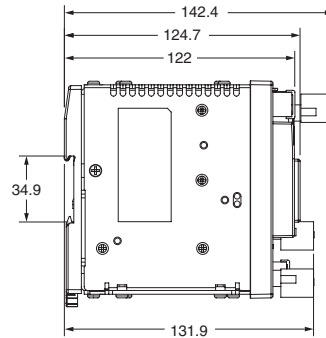

Mounting Rail (Material: Aluminum)

PFP-100N
PFP-50N

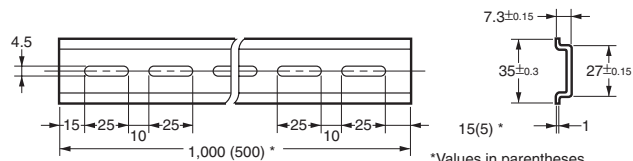
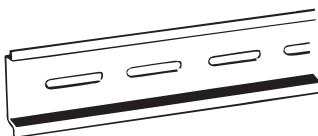

Model
PFP-100N
PFP-50N

*Values in parentheses are for the PFP-50N.

Mounting Rail (Material: Aluminum)

Mounting Rail (Material: Aluminum)

PFP-100N
PFP-50N

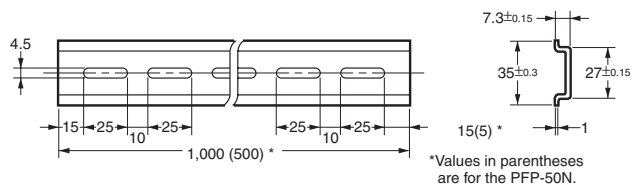
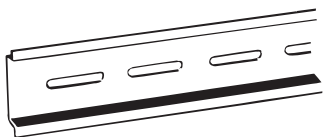

Model
PFP-100N
PFP-50N

Mounting Rail (Material: Aluminum)

PFP-100N2

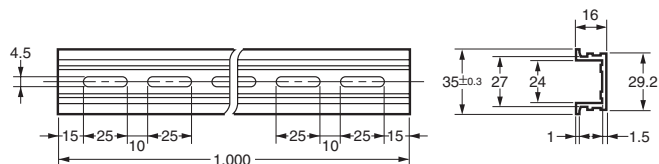
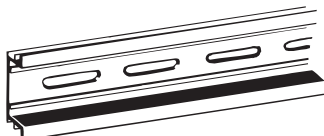

Model
PFP-100N2

Mounting Rail (Order Separately)

End Plate
PFP-M

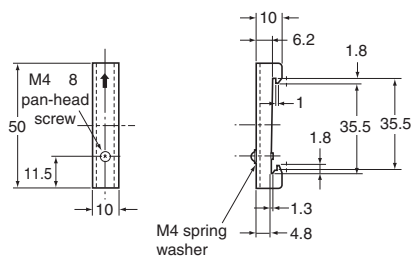
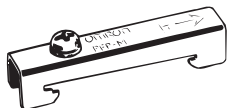

Model
PFP-M

Safety Precautions

Refer to *Safety Precautions for All Power Supplies*.

CAUTION

Minor electric shock, fire, or Product failure may occasionally occur. Do not disassemble, modify, or repair the Product or touch interior of the Product.



Minor burns may occasionally occur. Do not touch the Product during power is being supplied or immediately after power is turned OFF.



Minor injury may occasionally occur due to electrical shock. Do not touch the terminals while power is being supplied. Also, be sure to close the terminal cover after wiring the terminals.



Fire may occasionally occur. Tighten terminal screws to the specified torque.



Precautions for Safe Use

Mounting

- The long-term reliability of the S8AS can be increased by installing it properly and providing sufficient heat dissipation. Use the S8AS within the derating curve. The S8AS is designed to radiate heat by means of natural air circulation. Provide appropriate space as shown below to allow air flow around the Power Supplies.
- Poor heat dissipation resulting from improper installation conditions may occasionally deteriorate or damage internal parts and also cause the maintenance forecast monitor function to not operate properly. Do not use any mounting orientation other than a standard one.
- Poor heat dissipation may deteriorate or damage internal parts. Do not loosen the screws on the side of the Product.
- Do not allow any pieces of metal or conductors, or any clippings or cuttings resulting from installation work to enter the Product.

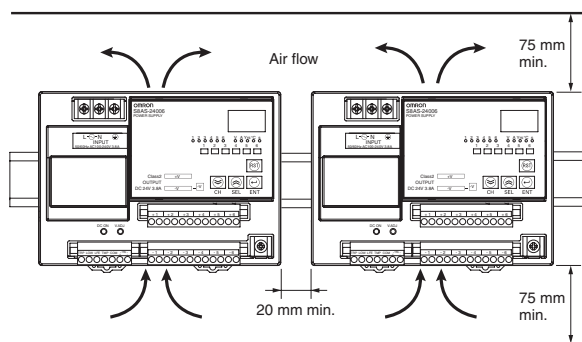

Attachment to the DIN Rail

To mount the block on a DIN Rail, until it makes a clicking sound, pull down the Rail stopper hook portion (A) of the Block onto the Rail, and press the Block in direction (B) to lock it in place.

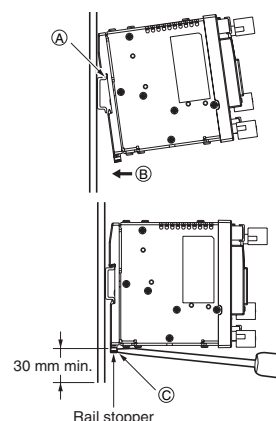

To dismount the Block, pull down portion (C) with a flat-blade screwdriver and pull out the Block.

Wiring

- Connect the ground completely. The ground is a protective earth (PE) terminal specified in safety standards. If the ground is not connected completely, electric shock or malfunction may occur.
- Minor fire may possibly occur. Ensure that input and output terminals are wired correctly.
- Heat generated by wiring materials may cause the temperature of internal parts to increase, which may result in deterioration of or damage to the internal parts. Select the wiring materials according to the current that is being used. Using the wiring materials, torque, and wire stripping lengths in the following table is recommended to prevent smoke or fire of the wire material due to an abnormal load.

Recommended Wire Diameter

Terminals	Name	Recommended wire diameter	Wire type	Torque	Wire stripping length
Screw terminals	AC input terminals and protective earth (PE) terminal	AWG14 to 16 (cross-sectional area of 0.823 to 2.081 mm ²)	Solid or stranded	9.6 in.lb. (1.08 N·m)	8 to 10 mm
	Branch output terminals (-), UL Standard	AWG12 to 14 (cross-sectional area of 2.081 to 3.309 mm ²)	Solid or stranded	12 in.lb. (1.36 N·m)	8 to 10 mm
	Branch output terminals (-), CSA Standard	AWG12 to 20 (cross-sectional area of 0.517 to 3.309 mm ²)	Solid or stranded	8.8 in.lb. (1.0 N·m)	8 to 10 mm
Screwless terminals	Branch output positive terminals, branch output negative terminals, I/O signal terminals, and communications terminals	AWG12 to 24 (cross-sectional area of 0.2 to 2.5 mm ²)	Solid or stranded	---	10 mm

- Do not push more than 100 N of force to the terminal block when tightening screws.
- Be sure to tighten the lock screws on the sides of the screwless connector after connecting it to the S8AS. When removing a screwless connector, be sure the lock screws are completely loose before pulling on the connector.
- Be sure to remove the sheet covering the Product during installation before turning ON the power.

Installation Environment

- Do not use the Product where it would be subjected to shock or vibration. A device such as a contact breaker may be a vibration source. Set the Product as far as possible from possible sources of shock or vibration. Additionally, install a PFP-M End Plate on each end of the Product after mounting it to a DIN Rail.
- If the Product is used in an area with excessive electronic noise, be sure to separate the Product as far as possible from the noise sources.

Ambient Operating and Storage Environment

- Store the Product at an ambient temperature of -25 to 65°C and relative humidity of 25% to 90%.
- Internal parts may occasionally be deteriorated or damaged. Do not use the Product in conditions exceeding the derating curve (in portion (1) of the Derating Curve on page 8).
- Use the Product where the relative humidity is 25% to 85%.
- Do not use the Product where it would be subjected to direct sunlight.
- Do not use the Product where it would be subjected to the possibility of penetration of liquid, foreign substance, or corrosive gas.
- To maintain performance of the maintenance forecast monitor, make sure the following conditions are satisfied for long-term storage. For storage exceeding three months, keep the Product at a temperature of -20°C to 30°C and a humidity of 25% to 70%.

Output Voltage Adjustment

- The output voltage adjuster (V.ADJ.) may possibly become damaged. Do not apply more than the required force.
- Do not exceed the rated output capacity and rated total output current after adjusting the output voltage.

Periodic Inspections

Under normal operating conditions, the Product will require several years or even more than ten years until the maintenance forecast monitor function operates. When using the Product for an extended period of time, perform the following procedure periodically to confirm that the output for the maintenance forecast monitor function (LFE) is operating correctly.

- Change to Run Mode.
- Confirm that the (LFE) output is ON (i.e., that there is electrical continuity between (LEF) and (COM)).

Precautions for Correct Use

Tripping Performance

- When the tripping alarm output operates, always remove the cause of the output first and then reset the alarm.
- When using a load with a fixed-power operation, the S8AS may cause a cutoff when the power supply is turned OFF.
- Outputs may be cut off by the abnormal voltage protection with loads that generate reverse peak electromotive force.
- Tripping performance is depends on the ambient operating temperature. Use the Product within the derating range. Refer to the *Derating Curve* on page 8.
- It is conceivable that internal parts may be deteriorated or damaged. Do not repeatedly perform cutoff or recovery operations more than necessary.

Maintenance Forecast Monitor Function

The accuracy of the maintenance forecast monitor function will be reduced in applications where the AC input turns ON and OFF frequently.

Total Peak Output Current

The S8AS is designed to provide a temporary peak current to provide the overcurrent required to start load devices.

The total peak output current for all branch outputs combined is given below. However, if even one of the following conditions is not satisfied by the total current, all branch outputs will be cut off to ensure safety based on the amount of peak current and the usage time.

- 240-W Models
Input voltage range: 200 to 240 VAC
Total peak current/Peak current pulse width:
17 A max./2 s max. 15 A max./5 s max.
13 A max./10 s max. 12 A max./20 s max.
- 480-W Models
Input voltage range: 200 to 240 VAC
Total peak current/Peak current pulse width:
27 A max./1 s max. 25 A max./2 s max.
22.5 A max./5 s max.

- Note:**
1. If the input voltage range is outside of the range given above, or if the total output current exceeds the maximum peak current, the S8AS may be cut off due to unstable internal operation.
 2. After the load device has been started, ensure that the total current in steady state remains within the rated values.
 3. When the peak current has exceeded the rated current, do not allow the peak current to flow again for the next 60 seconds.

Startup Sequence and Shutdown Sequence

The sequencing functions are designed for the branch outputs of one S8AS. There is no synchronizing processing between S8AS when more than one S8AS is used.

Startup Delay

The startup delay will not operate when a relay or other device is used for ON/OFF control on the output side of the S8AS, so a cutoff operation may occasionally occur.

Dielectric Strength Test

- The S8AS is designed to withstand 3,000 VAC for 1 minute between the AC input terminals collectively and the branch output, I/O signal, or communications terminals collectively. When testing, set the cutoff current for the withstand voltage test device to 20 mA.
- The S8AS may possibly be damaged from the impulse voltage if a testing device switch is used to abruptly apply or cut off 3000 VAC. Increase the applied voltage gradually using the voltage adjustment on the testing device.
- When testing terminals together, always short the specified terminals so that the voltage is applied to all of the terminals at the same time.

Insulation Resistance Test

- When testing the insulation resistance, use a DC resistance meter at 500 VDC.
- To prevent damage, always short branch output terminals (+/-), all I/O terminals, and communications terminals before testing.

Output Voltage Adjustment

- If the output voltage is set to less than 20 V (default setting), the undervoltage alarm may be activated.
- Do not exceed the rated output capacity and rated total output current after adjusting the output voltage.
- The output voltage may increase beyond the allowable voltage range rated voltage +10% when the V.ADJ adjuster is used. When adjusting the output voltage, check the output voltage of the power supply to make sure that the load is not damaged.

Displaying the Output Voltage

The voltage detection is performed on the voltage after AC/DC conversion in the interval circuits. The displayed voltage will be somewhat different from the value at the output terminals of the power source due to internal voltage drop. To confirm correct output voltages, measure the voltages at the branch output terminals.

No Output Voltage

The internal circuit's overcurrent protection or overvoltage protection may operate. Alternatively, the latch protection circuit may operate if there is a lightning inrush or other large voltage applied to the input. Contact your OMRON representative if there is still no output voltage after checking the following two points:

- Checking Overcurrent Protection
 - Check whether the load is in an overcurrent or short-circuited state.
 - Remove the wires to the load before checking.
- Checking Overvoltage Protection and Latching Protection
 - Turn the power supply OFF and leave it OFF for at least 3 minutes, then turn it ON again.

Startup Time

At startup, the S8AS will check hardware and software before starting the operation of branch outputs. A time of approximately 3 seconds is required for these self-diagnostic functions. Take this time into account when designing the system.

External Tripping Input

- Wire the polarity of the external tripping input correctly.
- After completing wiring, confirm that operation is correct.

Tripping Alarm Output, Undervoltage Detection Output, Maintenance Forecast Monitor Output, and Over-temperature Output

Photoswitch outputs: 30 VDC max., 50 mA max., residual voltage when ON: 2 V max., leakage current when OFF: 0.1 mA max.

- Wire all output signal circuits correctly.
- Internal current control circuits are not provided internally for output signals. Do not allow the output current to exceed 50 mA.
- After completing wiring, confirm that the circuits operate correctly.

Prohibition of Parallel Connection

Do not connect branch outputs from the S8AS in parallel. Also, do not connect the branch outputs in parallel with branch outputs of other S8AS Power Supplies.

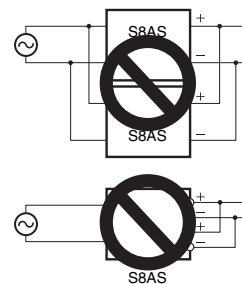

Connections cannot be made in parallel with other branch output circuits.

Connecting Backup Devices

Do not connect a battery or other backup power supply to the output of the Product.

Harmonic Current Suppression Circuit

A harmonic current suppression circuit is built into the Power Supply. This circuit can create noise when the input is turned ON, but it will last only until the internal circuits stabilize and does not indicate any problem in the Product.

Terms and Conditions of Sale

1. **Offer; Acceptance.** These terms and conditions (these "**Terms**") are deemed part of all quotes, agreements, purchase orders, acknowledgments, price lists, catalogs, manuals, brochures and other documents, whether electronic or in writing, relating to the sale of products or services (collectively, the "**Products**") by Omron Electronics LLC and its subsidiary companies ("**Omron**"). Omron objects to any terms or conditions proposed in Buyer's purchase order or other documents which are inconsistent with, or in addition to, these Terms.
2. **Prices; Payment Terms.** All prices stated are current, subject to change without notice by Omron. Omron reserves the right to increase or decrease prices on any unshipped portions of outstanding orders. Payments for Products are due net 30 days unless otherwise stated in the invoice.
3. **Discounts.** Cash discounts, if any, will apply only on the net amount of invoices sent to Buyer after deducting transportation charges, taxes and duties, and will be allowed only if (i) the invoice is paid according to Omron's payment terms and (ii) Buyer has no past due amounts.
4. **Interest.** Omron, at its option, may charge Buyer 1-1/2% interest per month or the maximum legal rate, whichever is less, on any balance not paid within the stated terms.
5. **Orders.** Omron will accept no order less than \$200 net billing.
6. **Governmental Approvals.** Buyer shall be responsible for, and shall bear all costs involved in, obtaining any government approvals required for the importation or sale of the Products.
7. **Taxes.** All taxes, duties and other governmental charges (other than general real property and income taxes), including any interest or penalties thereon, imposed directly or indirectly on Omron or required to be collected directly or indirectly by Omron for the manufacture, production, sale, delivery, importation, consumption or use of the Products sold hereunder (including customs duties and sales, excise, use, turnover and license taxes) shall be charged to and remitted by Buyer to Omron.
8. **Financial.** If the financial position of Buyer at any time becomes unsatisfactory to Omron, Omron reserves the right to stop shipments or require satisfactory security or payment in advance. If Buyer fails to make payment or otherwise comply with these Terms or any related agreement, Omron may (without liability and in addition to other remedies) cancel any unshipped portion of Products sold hereunder and stop any Products in transit until Buyer pays all amounts, including amounts payable hereunder, whether or not then due, which are owing to it by Buyer. Buyer shall in any event remain liable for all unpaid accounts.
9. **Cancellation; Etc.** Orders are not subject to rescheduling or cancellation unless Buyer indemnifies Omron against all related costs or expenses.
10. **Force Majeure.** Omron shall not be liable for any delay or failure in delivery resulting from causes beyond its control, including earthquakes, fires, floods, strikes or other labor disputes, shortage of labor or materials, accidents to machinery, acts of sabotage, riots, delay in or lack of transportation or the requirements of any government authority.
11. **Shipping; Delivery.** Unless otherwise expressly agreed in writing by Omron:
 - a. Shipments shall be by a carrier selected by Omron; Omron will not drop ship except in "break down" situations.
 - b. Such carrier shall act as the agent of Buyer and delivery to such carrier shall constitute delivery to Buyer;
 - c. All sales and shipments of Products shall be FOB shipping point (unless otherwise stated in writing by Omron), at which point title and risk of loss shall pass from Omron to Buyer; provided that Omron shall retain a security interest in the Products until the full purchase price is paid;
 - d. Delivery and shipping dates are estimates only; and
 - e. Omron will package Products as it deems proper for protection against normal handling and extra charges apply to special conditions.
12. **Claims.** Any claim by Buyer against Omron for shortage or damage to the Products occurring before delivery to the carrier must be presented in writing to Omron within 30 days of receipt of shipment and include the original transportation bill signed by the carrier noting that the carrier received the Products from Omron in the condition claimed.
13. **Warranties.** (a) **Exclusive Warranty.** Omron's exclusive warranty is that the Products will be free from defects in materials and workmanship for a period of twelve months from the date of sale by Omron (or such other period expressed in writing by Omron). Omron disclaims all other warranties, express or implied. (b) **Limitations.** OMRON MAKES NO WARRANTY OR REPRESENTATION, EXPRESS OR IMPLIED, ABOUT NON-INFRINGEMENT, MERCHANTABILITY OR FITNESS FOR A PARTICULAR PURPOSE OF THE PRODUCTS. BUYER ACKNOWLEDGES THAT IT ALONE HAS DETERMINED THAT THE PRODUCTS WILL SUITABLY MEET THE REQUIREMENTS OF THEIR INTENDED USE. Omron further disclaims all warranties and responsibility of any type for claims or expenses based on infringement by the Products or otherwise of any intellectual property right. (c) **Buyer Remedy.** Omron's sole obligation hereunder shall be, at Omron's election, to (i) replace (in the form originally shipped with Buyer responsible for labor charges for removal or replacement thereof) the non-complying Product, (ii) repair the non-complying Product, or (iii) repay or credit Buyer an amount equal to the purchase price of the non-complying Product; provided that in no event shall Omron be responsible for warranty, repair, indemnity or any other claims or expenses regarding the Products unless Omron's analysis confirms that the Products were properly handled, stored, installed and maintained and not subject to contamination, abuse, misuse or inappropriate modification. Return of any Products by Buyer must be approved in writing by Omron before shipment. Omron Companies shall not be liable for the suitability or unsuitability or the results from the use of Products in combination with any electrical or electronic components, circuits, system assemblies or any other materials or substances or environments. Any advice, recommendations or information given orally or in writing, are not to be construed as an amendment or addition to the above warranty. See <http://www.omron247.com> or contact your Omron representative for published information.
14. **Limitation on Liability; Etc.** OMRON COMPANIES SHALL NOT BE LIABLE FOR SPECIAL, INDIRECT, INCIDENTAL, OR CONSEQUENTIAL DAMAGES, LOSS OF PROFITS OR PRODUCTION OR COMMERCIAL LOSS IN ANY WAY CONNECTED WITH THE PRODUCTS, WHETHER SUCH CLAIM IS BASED IN CONTRACT, WARRANTY, NEGLIGENCE OR STRICT LIABILITY. Further, in no event shall liability of Omron Companies exceed the individual price of the Product on which liability is asserted.
15. **Indemnities.** Buyer shall indemnify and hold harmless Omron Companies and their employees from and against all liabilities, losses, claims, costs and expenses (including attorney's fees and expenses) related to any claim, investigation, litigation or proceeding (whether or not Omron is a party) which arises or is alleged to arise from Buyer's acts or omissions under these Terms or in any way with respect to the Products. Without limiting the foregoing, Buyer (at its own expense) shall indemnify and hold harmless Omron and defend or settle any action brought against such Companies to the extent based on a claim that any Product made to Buyer specifications infringed intellectual property rights of another party.
16. **Property; Confidentiality.** Any intellectual property in the Products is the exclusive property of Omron Companies and Buyer shall not attempt to duplicate it in any way without the written permission of Omron. Notwithstanding any charges to Buyer for engineering or tooling, all engineering and tooling shall remain the exclusive property of Omron. All information and materials supplied by Omron to Buyer relating to the Products are confidential and proprietary, and Buyer shall limit distribution thereof to its trusted employees and strictly prevent disclosure to any third party.
17. **Export Controls.** Buyer shall comply with all applicable laws, regulations and licenses regarding (i) export of products or information; (ii) sale of products to "forbidden" or other proscribed persons; and (iii) disclosure to non-citizens of regulated technology or information.
18. **Miscellaneous.** (a) **Waiver.** No failure or delay by Omron in exercising any right and no course of dealing between Buyer and Omron shall operate as a waiver of rights by Omron. (b) **Assignment.** Buyer may not assign its rights hereunder without Omron's written consent. (c) **Law.** These Terms are governed by the law of the jurisdiction of the home office of the Omron company from which Buyer is purchasing the Products (without regard to conflict of law principles). (d) **Amendment.** These Terms constitute the entire agreement between Buyer and Omron relating to the Products, and no provision may be changed or waived unless in writing signed by the parties. (e) **Severability.** If any provision hereof is rendered ineffective or invalid, such provision shall not invalidate any other provision. (f) **Setoff.** Buyer shall have no right to set off any amounts against the amount owing in respect of this invoice. (g) **Definitions.** As used herein, "including" means "including without limitation"; and "Omron Companies" (or similar words) mean Omron Corporation and any direct or indirect subsidiary or affiliate thereof.

Certain Precautions on Specifications and Use

1. **Suitability of Use.** Omron Companies shall not be responsible for conformity with any standards, codes or regulations which apply to the combination of the Product in the Buyer's application or use of the Product. At Buyer's request, Omron will provide applicable third party certification documents identifying ratings and limitations of use which apply to the Product. This information by itself is not sufficient for a complete determination of the suitability of the Product in combination with the end product, machine, system, or other application or use. Buyer shall be solely responsible for determining appropriateness of the particular Product with respect to Buyer's application, product or system. Buyer shall take application responsibility in all cases but the following is a non-exhaustive list of applications for which particular attention must be given: (i) Outdoor use, uses involving potential chemical contamination or electrical interference, or conditions or uses not described in this document. (ii) Use in consumer products or any use in significant quantities. (iii) Energy control systems, combustion systems, railroad systems, aviation systems, medical equipment, amusement machines, vehicles, safety equipment, and installations subject to separate industry or government regulations. (iv) Systems, machines and equipment that could present a risk to life or property. Please know and observe all prohibitions of use applicable to this Product. NEVER USE THE PRODUCT FOR AN APPLICATION INVOLVING SERIOUS RISK TO LIFE OR PROPERTY OR IN LARGE QUANTITIES WITHOUT ENSURING THAT THE SYSTEM AS A WHOLE HAS BEEN DESIGNED TO ADDRESS THE RISKS, AND THAT THE OMRON'S PRODUCT IS PROPERLY RATED AND INSTALLED FOR THE INTENDED USE WITHIN THE OVERALL EQUIPMENT OR SYSTEM.
2. **Programmable Products.** Omron Companies shall not be responsible for the user's programming of a programmable Product, or any consequence thereof.
3. **Performance Data.** Data presented in Omron Company websites, catalogs and other materials is provided as a guide for the user in determining suitability and does not constitute a warranty. It may represent the result of Omron's test conditions, and the user must correlate it to actual application requirements. Actual performance is subject to the Omron's Warranty and Limitations of Liability.
4. **Change in Specifications.** Product specifications and accessories may be changed at any time based on improvements and other reasons. It is our practice to change part numbers when published ratings or features are changed, or when significant construction changes are made. However, some specifications of the Product may be changed without any notice. When in doubt, special part numbers may be assigned to fix or establish key specifications for your application. Please consult with your Omron's representative at any time to confirm actual specifications of purchased Product.
5. **Errors and Omissions.** Information presented by Omron Companies has been checked and is believed to be accurate; however, no responsibility is assumed for clerical, typographical or proofreading errors or omissions.

OMRON INDUSTRIAL AUTOMATION • THE AMERICAS HEADQUARTERS • Schaumburg, IL USA • 847.843.7900 • 800.556.6766 • www.omron247.com

OMRON CANADA, INC. • HEAD OFFICE

Toronto, ON, Canada • 416.286.6465 • 866.986.6766 • www.omron247.com

OMRON ELECTRONICS DE MEXICO • HEAD OFFICE

México DF • 52.55.59.01.43.00 • 001.800.556.6766 • mela@omron.com

OMRON ELECTRONICS DE MEXICO • SALES OFFICE

Apodaca, N.L. • 52.81.11.56.99.20 • 001.800.556.6766 • mela@omron.com

OMRON ELETRÔNICA DO BRASIL LTDA • HEAD OFFICE

São Paulo, SP, Brasil • 55.11.2101.6300 • www.omron.com.br

OMRON ARGENTINA • SALES OFFICE

Cono Sur • 54.11.4783.5300

OMRON CHILE • SALES OFFICE

Santiago • 56.9.9917.3920

OTHER OMRON LATIN AMERICA SALES

54.11.4783.5300

OMRON EUROPE B.V. • Wegalaan 67-69, NL-2132 JD, Hoofddorp, The Netherlands. • Tel: +31 (0) 23 568 13 00 • Fax: +31 (0) 23 568 13 88 • www.industrial.omron.eu

Authorized Distributor:

Automation Systems

- Programmable logic controllers (PLC) • Human machine interfaces (HMI) • Remote I/O
- Industrial PC's • Software

Motion & Drives

- Motion controllers • Servo systems • AC drives

Control Components

- Temperature controllers • Power supplies • Timers • Counters • Programmable relays
- Digital panel indicators • Electromechanical relays • Monitoring products • Solid-state relays
- Limit switches • Pushbutton switches • Low voltage switch gear

Sensing & Safety

- Photoelectric sensors • Inductive sensors • Capacitive & pressure sensors
- Cable connectors • Displacement & width-measuring sensors • Vision systems
- Safety networks • Safety sensors • Safety units/relay units • Safety door/guard lock switches