

Assemblies type RY440 are design

Package details

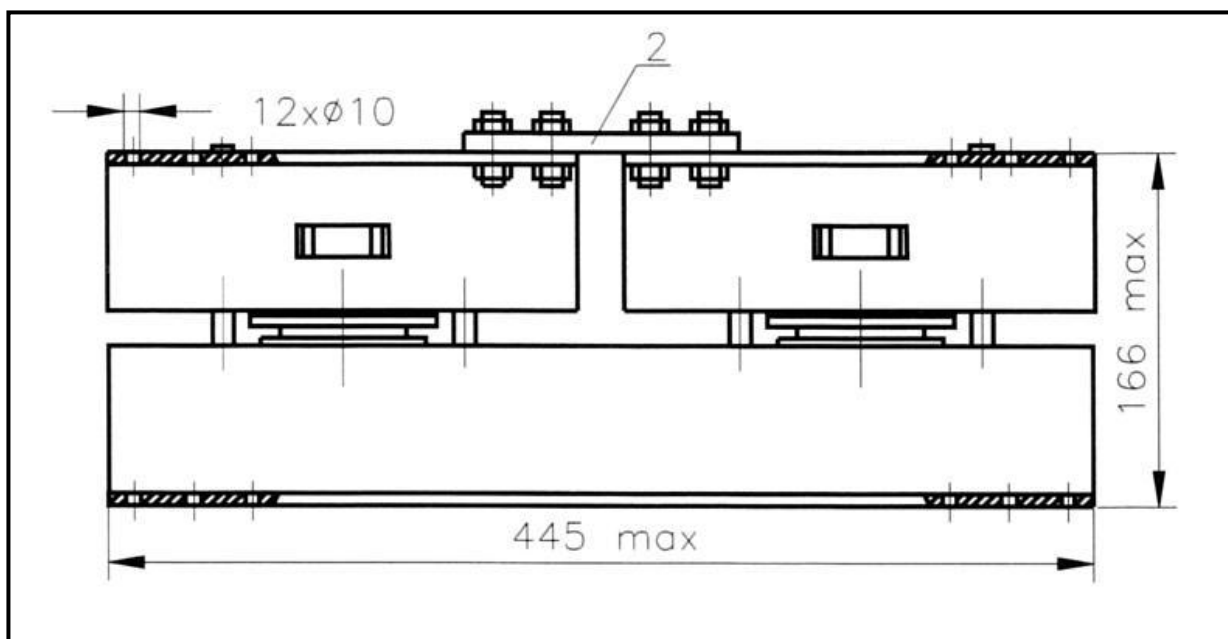

For further package information, please contact Sales & Marketing Department.
Do not scale.