



- Features :
 - True sine wave output (THD<3%)
 - High surge power up to 3000W
 - U.P.S. mode and energy saving mode (selectable)
 - High efficiency up to 91%
 - Power ON-OFF switch
 - Standby saving mode can be selectable
 - Front panel indicator for operation status
 - Thermostatically controlled cooling fan
 - Protections: Bat. low alarm / Bat. low shutdown / Over voltage / Over temp. / Output short / Input polarity reverse / Overload / AC circuit breaker
 - Application : Home appliance, power tools, office and portable equipment, vehicle and yacht ...etc.
 - Built-in solar / AC charger
 - Computer-based monitoring software (Note.7)
 - 3 years warranty



SPECIFICATION

MODEL	TN-1500-112□	TN-1500-124□	TN-1500-148□	TN-1500-212□	TN-1500-224□	TN-1500-248□		
OUTPUT	RATED POWER (Typ.)		1500W					
	MAXIMUM OUTPUT POWER (Typ.)		1725W for 180 sec. / 1875W for 10 sec. / surge power 3000W for 30 cycles					
	AC VOLTAGE		Factory setting set at 110VAC 100 / 110 / 115 / 120VAC selectable by setting button S.W		Factory setting set at 230VAC 200 / 220 / 230 / 240VAC selectable by setting button S.W			
	FREQUENCY		60±0.1Hz 50/60Hz selectable by setting button S.W		50±0.1Hz 50/60Hz selectable by setting button S.W			
	WAVEFORM <small>Note.2</small>		True sine wave (THD<3%) at rated input voltage					
	AC REGULATION (Typ.)		±3.0%					
	TRANSFER TIME (Typ.)		10ms inverter → → by pass					
	SAVING MODE (Typ.)		Default disabled. Load ≤5W will be changed to standby mode					
FRONT PANEL INDICATOR		Battery voltage level, output load level, saving mode, fault and operation status						
INPUT	BAT. VOLTAGE	12V	24V	48V	12V	24V	48V	
	VOLTAGE RANGE (Typ.) <small>Note.3,6</small>	10.5 ~ 15VDC	21 ~ 30VDC	42 ~ 60VDC	10.5 ~ 15VDC	21 ~ 30VDC	42 ~ 60VDC	
	DC CURRENT (Typ.) <small>Note.5</small>	150A	75A	37.5A	150A	75A	37.5A	
	NO LOAD DISSIPATION	≤18W @ standby saving mode						
	OFF MODE CURRENT DRAW	≤1mA						
	EFFICIENCY (Typ.) <small>Note.2</small>	87%	89%	89%	88%	90%	91%	
	BATTERY TYPES	Open & sealed Lead Acid						
BATTERY INPUT PROTECTION	FUSE	40A*5	30A*3	30A*2	40A*5	30A*3	30A*2	
	BAT. LOW ALARM	11.3±4%	22.5±4%	45±4%	11.3±4%	22.5±4%	45±4%	
	BAT. LOW SHUTDOWN	10.5±4%	21±4%	42±4%	10.5±4%	21±4%	42±4%	
	REVERSE POLARITY	By internal fuse open						
OUTPUT PROTECTION	OVER TEMPERATURE	82°C ±5°C	82°C ±5°C	96°C ±5°C	68°C ±5°C	68°C ±5°C	68°C ±5°C	
	OUTPUT SHORT	Protection type : Shut down o/p voltage, re-power on to recover ; by internal RTH3 detect on heatsink of power transistor						
	OVER LOAD (Typ.)	105 ~ 115% load for 180 sec., 115% ~ 125% load for 10 sec. Protection type : Shut down o/p voltage, re-power on to recover						
	CIRCUIT BREAKER	20A			10A			
	GFCI PROTECTION	Optional (Only type F)			None			
	WORKING TEMP. <small>Note.1</small>	0 ~ +40°C @ 100% load ; 60°C @ 50% load						
ENVIRONMENT	WORKING HUMIDITY	20% ~ 90% RH non-condensing						
	STORAGE TEMP., HUMIDITY	-30 ~ +70°C / -22 ~ +158°F, 10 ~ 95% RH						
	VIBRATION	10 ~ 500Hz, 3G 10min./1cycle, 60min. each along X, Y, Z axes						
SAFETY & EMC	SAFETY STANDARDS	UL458 (only for "GFCI" receptacle-Type F) None						
	LVD	None			EN60950-1			
	WITHSTAND VOLTAGE	Bat I/P - AC I/P:3.0KVAC Bat I/P - AC O/P:3.0KVAC AC O/P - FG:1.5KVAC						
	EMC EMISSION	Compliance to FCC class A			Compliance to EN55022 class B, 72/ 245/ CEE, 95/ 54/ CE, E-Mark			
	EMC IMMUNITY	None			Compliance to EN61000-4-2,3,4,5,6,8,11			
AC CHARGER	CHARGE CURRENT (Typ.)	5.5A	2.7A	1.35A	5.5A	2.7A	1.35A	
	CHARGE VOLTAGE	14.3V ±4%	28.5V ±4%	57V ±4%	14.3V ±4%	28.5V ±4%	57V ±4%	
	MAX OPEN CIRCUIT VOLTAGE	25V	45V	75V	25V	45V	75V	
SOLAR CHARGER	CHARGE CURRENT (max.)	30A						
	CHARGE VOLTAGE	14.3V ±4%	28.5V ±4%	57V ±4%	14.3V ±4%	28.5V ±4%	57V ±4%	
OTHERS	CONTROL WIRING <small>Note.7</small>	RJ11 -RS232						
	DIMENSION	420*220*88mm (L*W*H)						
	PACKING	6.85Kg; 2pcs/15.7Kg/1.61CUFT						
NOTE	1. Output derating capacity referenced by curve 1. 2. THD and Efficiency is tested by 1000W, linear load at 13V, 26V, 52V input voltage. 3. Input derating capacity referenced by curve 2. 4. All parameters not specified above are measured at rated load, 25°C of ambient temperature. 5. DC current is tested by 1500W, linear load at 13V, 26V, 52V input voltage. 6. The tolerance of each voltage value by models is: 112/212 → ±0.5V; 124/224 → ±1V; 148/248 → ±2V. 7. The cable is enclosed for the connection between TN-1500 and computer for software monitoring.							

■ Instructions for TN-1500 monitoring software

1. The monitoring software can be downloaded from product section (with TN-1500 specification) on MEAN WELL's official website, <http://www.meanwell.com>
2. The monitoring software can run on Windows 7 English version, Windows 7 Chinese (Traditional, Taiwan) version, Windows 8 English version and Windows 8 Chinese (Traditional, Taiwan) version
3. Installation of TN-1500 unit and PC

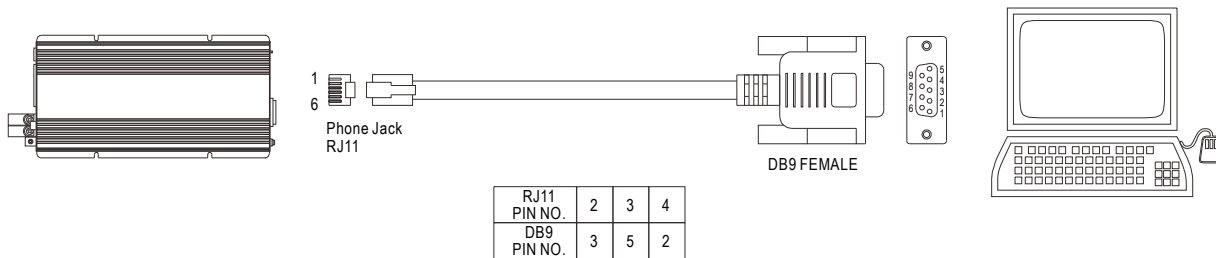

Figure 1

4. Explanation of Monitoring Manu

4.1 Main Page

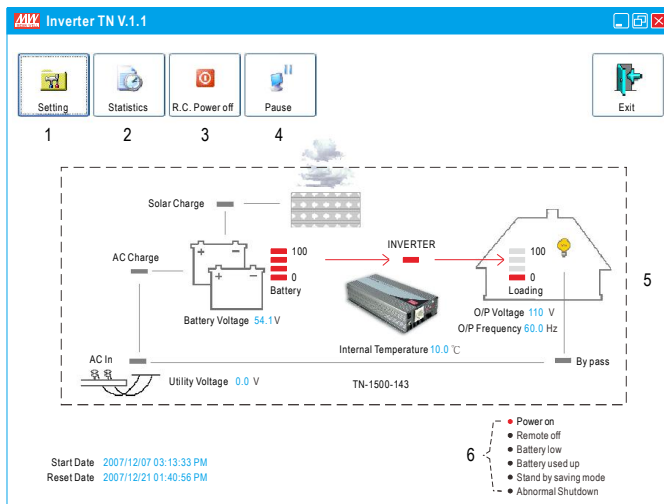

Figure 2

1. Setting: Adjustment for output voltage, charging related voltage, frequency, and operation mode. Please refer to Figure 3 for details.
2. Statistics: Calculate for the percentage of operating period for each operation mode. Please refer to Figure 4 for details.
3. R.C. Power off: Power can be turned ON or OFF at the remote location.
4. Pause: Stop refreshing the page of monitoring software.
5. Status of unit: Indicating current operating status of TN-1500.
6. Signals that display current condition of the unit.

4.2 Setting Page

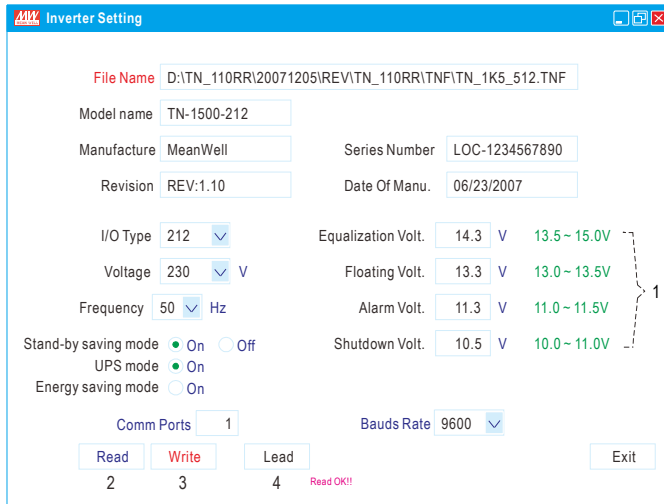

Figure 3

1. User can adjust the settings based on the characteristics of batteries been used: Equalization Voltage, Floating Voltage, Alarm Voltage, and Shut-down Voltage. UPS Mode / Energy Saving Mode selection and AC output voltage and frequency can also be set in this page.
2. Read: Read current settings of the unit.
3. Write: Write the revised setting into the unit.
4. Load: Load in factory default settings.

4.3 Statistic Page

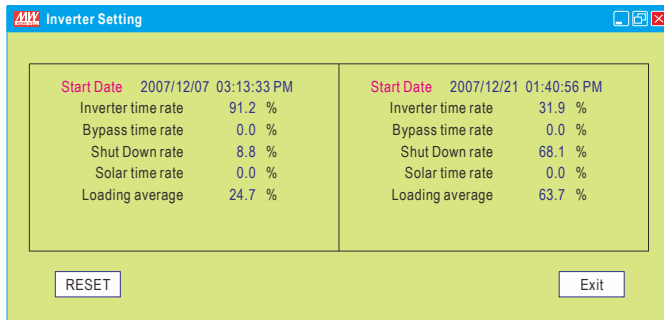
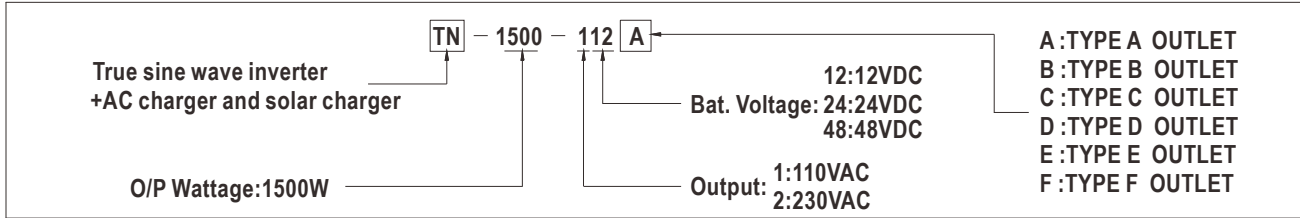

Figure 4

1. Start Date: Date that installing the monitoring software.
2. Reset Date: Date that resetting the statistics. The Start Date will not be influenced by resetting the statistics or turning off the unit.
3. Inverter time rate: Operating period of "Inverter Mode" represents how many percent of the whole operating period.
4. Bypass time rate: Operating period of "Bypass Mode" (energy provides directly by the utility) represents how many percent of the whole operating period.
5. Shut down rate: Percentage of time period that the unit is under the condition of shut down.
*** Inverter time rate + Bypass time rate + Shut down rate = 100%**
6. Solar time rate: Percentage of time period that the solar charger is functioning after turning on the TN-1500 unit.
7. Loading average: Average loading after turning on the TN-1500 unit.



■ AC Output Receptacles (optional)

Receptacle type						
	TYPE-A	TYPE-B	TYPE-C	TYPE-D	TYPE-E	TYPE-F
Country	USA	EUROPE	AUSTRALIA	U.K	JAPAN	GFCI
Certificate						

■ Mechanical Specification

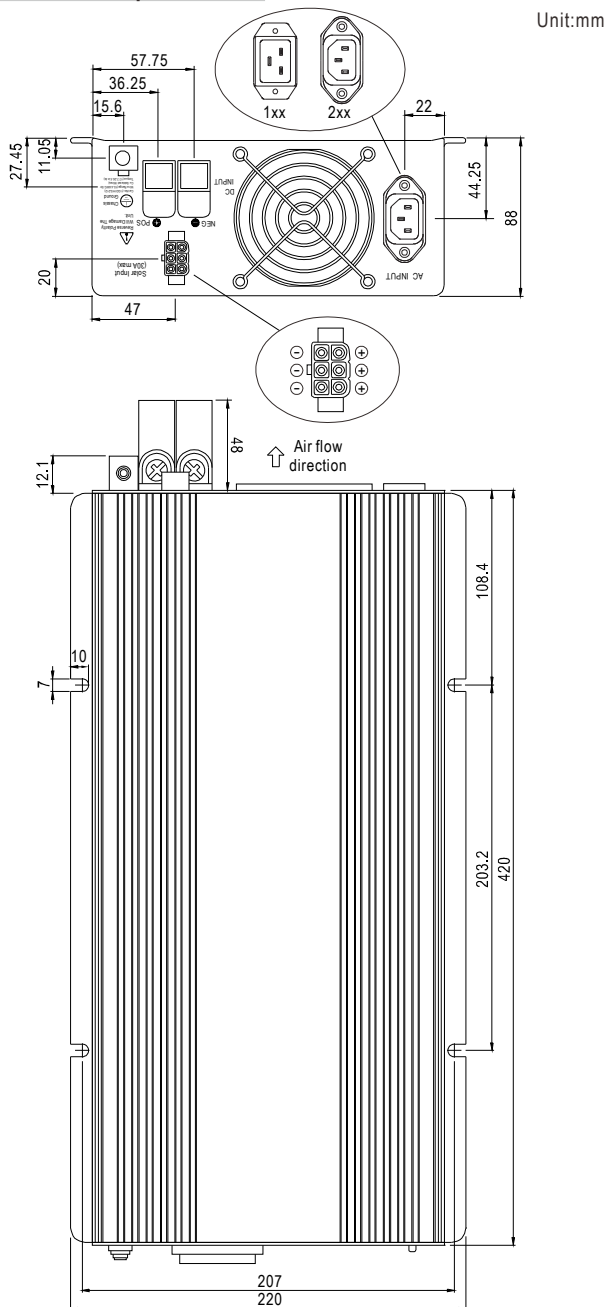

■ Derating Curve

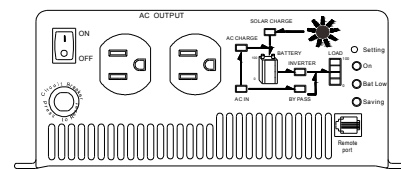
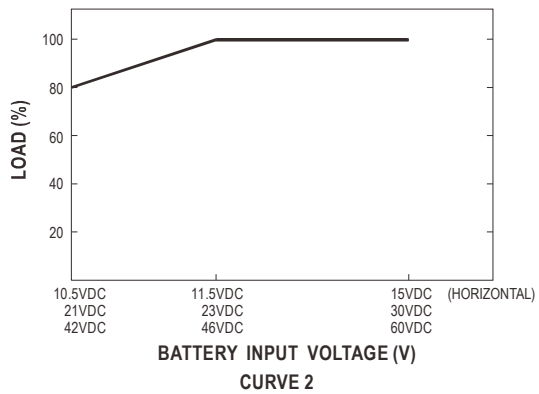
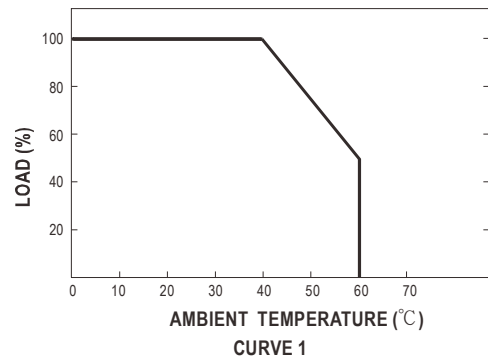

Type-A

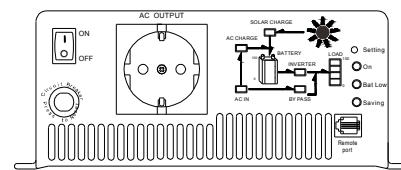

Type-B