

# HMI

TP | 62K-JJK0 | Manual

HB160 | TP | 62K-JJK0 | en | 23-10

Touch Panel - TP 610C



YASKAWA Europe GmbH  
Philipp-Reis-Str. 6  
65795 Hattersheim  
Germany  
Tel.: +49 6196 569-300  
Fax: +49 6196 569-398  
Email: [info@yaskawa.eu](mailto:info@yaskawa.eu)  
Internet: [www.yaskawa.eu.com](http://www.yaskawa.eu.com)

## Table of contents

<b>1</b>	<b>General</b> .....	<b>4</b>
1.1	Copyright © YASKAWA Europe GmbH.....	4
1.2	About this manual.....	5
1.3	Safety information.....	6
<b>2</b>	<b>Hardware description</b> .....	<b>7</b>
2.1	Safety information for users.....	7
2.2	Properties.....	8
2.3	Structure.....	9
2.3.1	Overview.....	9
2.3.2	Interfaces.....	10
2.3.3	Memory management.....	12
2.4	Dimensions.....	14
2.5	General data.....	15
2.6	Use in difficult operating conditions.....	16
2.7	Technical data.....	17
2.7.1	62K-JKK0-EB.....	17
<b>3</b>	<b>Deployment Touch Panel</b> .....	<b>20</b>
3.1	Installation.....	20
3.2	Commissioning.....	22
3.2.1	Startup-Manager.....	22
3.3	Connection to a PLC system.....	26
3.3.1	Overview.....	26
3.3.2	Integrated server.....	26
3.3.3	Communication via ActiveSync.....	31
3.4	Operating system Windows Embedded Compact 7.....	33
3.4.1	General.....	33
3.4.2	Structure.....	34
3.5	Access to the network resources.....	38
<b>4</b>	<b>Industrial Security and Installation guidelines</b> .....	<b>40</b>
4.1	Industrial security in information technology.....	40
4.1.1	Protection of hardware and applications.....	41
4.1.2	Protection of PC-based software.....	42
4.2	Installation guidelines.....	42
4.2.1	Basic rules for the EMC-equitable assembly of installations.....	42
4.2.2	EMC-equitable assembly.....	46
4.2.3	EMC-equitable cabling.....	47
4.2.4	Special precautions providing high noise immunity.....	50
4.2.5	Checklist for the EMC-compliant installation of controllers.....	51
	<b>Appendix</b> .....	<b>52</b>
A	History of changes.....	53

# 1 General

## 1.1 Copyright © YASKAWA Europe GmbH

<b>All Rights Reserved</b>	<p>This document contains proprietary information of Yaskawa and is not to be disclosed or used except in accordance with applicable agreements.</p> <p>This material is protected by copyright laws. It may not be reproduced, distributed, or altered in any fashion by any entity (either internal or external to Yaskawa) except in accordance with applicable agreements, contracts or licensing, without the express written consent of Yaskawa and the business management owner of the material.</p> <p>For permission to reproduce or distribute, please contact: YASKAWA Europe GmbH, European Headquarters, Philipp-Reis-Str. 6, 65795 Hattersheim, Germany</p> <p>Tel.: +49 6196 569 300 Fax.: +49 6196 569 398 Email: <a href="mailto:info@yaskawa.eu">info@yaskawa.eu</a> Internet: <a href="http://www.yaskawa.eu.com">www.yaskawa.eu.com</a></p>
<b>EC conformity declaration</b>	<p>Hereby, YASKAWA Europe GmbH declares that the products and systems are in compliance with the essential requirements and other relevant provisions. Conformity is indicated by the CE marking affixed to the product.</p>
<b>Conformity Information</b>	<p>For more information regarding CE marking and Declaration of Conformity (DoC), please contact your local representative of YASKAWA Europe GmbH.</p>
<b>Trademarks</b>	<p>SPEED7 is a registered trademark of YASKAWA Europe GmbH.</p> <p>All Microsoft Windows, Office and Server products mentioned are registered trademarks of Microsoft Inc., USA.</p> <p>Portable Document Format (PDF) is a registered trademark of Adobe Systems, Inc.</p> <p>All other trademarks, logos and service or product marks specified herein are owned by their respective companies.</p>
<b>General terms of use</b>	<p>Every effort has been made to ensure that the information contained in this document was complete and accurate at the time of publishing. We cannot guarantee that the information is free of errors, and we reserve the right to change the information at any time. There is no obligation to inform the customer about any changes. The customer is requested to actively keep his documents up to date. The customer is always responsible for the deployment of the products with the associated documentation, taking into account the applicable directives and standards.</p> <p>This documentation describes all hardware and software units and functions known today. It is possible that units are described that do not exist at the customer. The exact scope of delivery is described in the respective purchase contract.</p>
<b>Document support</b>	<p>Contact your local representative of YASKAWA Europe GmbH if you have errors or questions regarding the content of this document. You can reach YASKAWA Europe GmbH via the following contact:</p> <p>Email: <a href="mailto:Documentation.HER@yaskawa.eu">Documentation.HER@yaskawa.eu</a></p>

**Technical support**

Contact your local representative of YASKAWA Europe GmbH if you encounter problems or have questions regarding the product. If such a location is not available, you can reach the Yaskawa customer service via the following contact:

YASKAWA Europe GmbH,  
European Headquarters, Philipp-Reis-Str. 6, 65795 Hattersheim, Germany  
Tel.: +49 6196 569 500 (hotline)  
Email: support@yaskawa.eu

**1.2 About this manual****Objective and contents**

This manual describes the Touch Panel 62K-JJK0-EB.

- It contains a description of the structure, project engineering and deployment.
- The manual is written for users with basic knowledge of automation technology.
- The manual consists of chapters. Each chapter describes a completed topic.
- The following guides are available in the manual:
  - An overall table of contents at the beginning of the manual.
  - References with pages numbers.

**Validity of the documentation**

Product	Order no.	as of version:	
TP 610C	62K-JJK0-EB	HW: 01	FW: V1.0.2

**Icons Headings**

Important passages in the text are highlighted by following icons and headings:

**DANGER!**

Immediate or likely danger. Personal injury is possible.

**CAUTION!**

Damages to property is likely if these warnings are not heeded.



*Supplementary information and useful tips.*

## 1.3 Safety information

### Applications conforming with specifications

The Touch Panels are constructed and produced for:

- communication and process control
- general control and automation tasks
- industrial applications
- operation within the environmental conditions specified in the technical data
- installation into a cubicle



#### **DANGER!**

This device is not certified for applications in

- in explosive environments (EX-zone)

### Documentation

The manual must be available to all personnel in the

- project design department
- installation department
- commissioning
- operation



#### **CAUTION!**

**The following conditions must be met before using or commissioning the components described in this manual:**

- Hardware modifications to the process control system should only be carried out when the system has been disconnected from power!
- Installation and hardware modifications only by properly trained personnel.
- The national rules and regulations of the respective country must be satisfied (installation, safety, EMC ...)

### Disposal

**National rules and regulations apply to the disposal of the unit!**

## 2 Hardware description

### 2.1 Safety information for users

#### Handling of electrostatic sensitive modules

The modules make use of highly integrated components in MOS-Technology. These components are extremely sensitive to over-voltages that can occur during electrostatic discharges. The following symbol is attached to modules that can be destroyed by electrostatic discharges.



The Symbol is located on the module, the module rack or on packing material and it indicates the presence of electrostatic sensitive equipment. It is possible that electrostatic sensitive equipment is destroyed by energies and voltages that are far less than the human threshold of perception. These voltages can occur where persons do not discharge themselves before handling electrostatic sensitive modules and they can damage components thereby, causing the module to become inoperable or unusable. Modules that have been damaged by electrostatic discharges can fail after a temperature change, mechanical shock or changes in the electrical load. Only the consequent implementation of protection devices and meticulous attention to the applicable rules and regulations for handling the respective equipment can prevent failures of electrostatic sensitive modules.

#### Shipping of modules

Modules must be shipped in the original packing material.

#### Measurements and alterations on electrostatic sensitive modules

When you are conducting measurements on electrostatic sensitive modules you should take the following precautions:

- Floating instruments must be discharged before use.
- Instruments must be grounded.

Modifying electrostatic sensitive modules you should only use soldering irons with grounded tips.



#### CAUTION!

Personnel and instruments should be grounded when working on electrostatic sensitive modules.

## 2.2 Properties

### General

The Touch Panel allows you to visualize and alter operating states and recent process values of a connected PLC. The Touch Panel is a compact and modular embedded PC based on Windows® CE. Besides the extensive Windows® CE functions the Touch Panel offers varied communication possibilities. Here the Touch Panel can simply be configured, controlled and remoted.



- Windows® Embedded Compact 7
- Movicon 11 CE Standard (4096 I/O bytes)
- Processor Freescale i.MX 6, ARM Cortex A9, 800 MHz
- Work memory 1GB
- User memory 8GB
- 6GB memory for user data
- CF-Card II and MMC/SD card slot
- RS232, RS422/485, MPI, PROFIBUS DP slave, Ethernet, USB-A and USB-B interfaces
- Robust aluminium die casting case
- Display SVGA 800 x 600 / 600 x 800 (16M colors)
- Battery backed clock
- Resistive touch screen
- Easy mounting via integrated pivoted lever
- Protection class IP65 (frontal)



## Order data

Type	Order number	Description
TP 610C	62K-JJK0-EB	10.4" SVGA, TFT color, MPI/PROFIBUS DP/RS485, RS232, RS422/485, 2xUSB-A, USB-B, 2xEthernet RJ45 (Switch)

## 2.3 Structure

## 2.3.1 Overview

## Front view

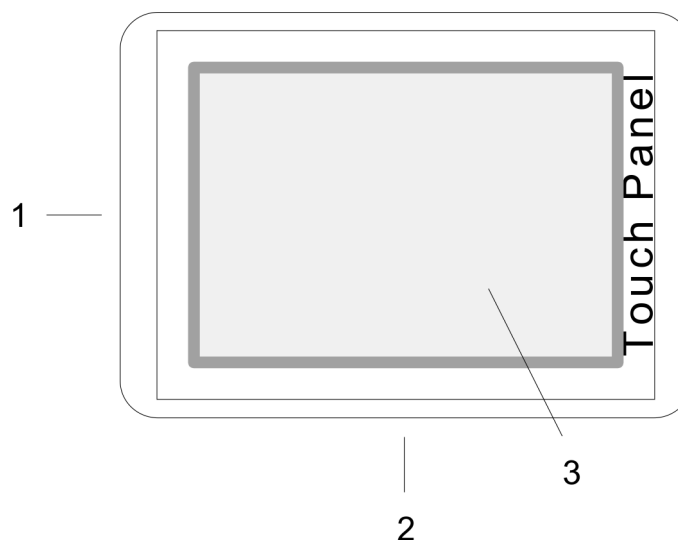

- 1 Slot for storage medium (CF, SD/MMC)
- 2 Connection for interfaces and power supply
- 3 Display with touch sensitive area (touch screen)

## Side view

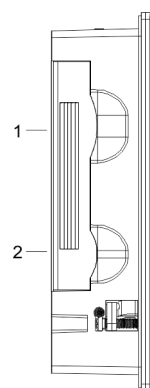

- 1 Compact Flash
- 2 MMC / SD

Bottom view (Interfaces)

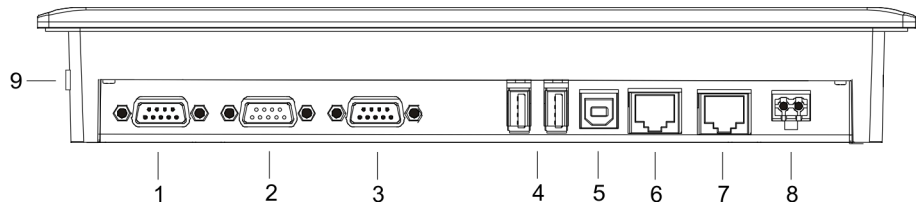

- 1 RS422/485 interface COM 2
- 2 RS232 interface COM 1
- 3 MPI/PROFIBUS DP/RS485 interface
- 4 2x "Host"-USB-A interfaces
- 5 "Slave"-USB-B interface
- 6 RJ45 jack for Ethernet communication
- 7 RJ45 jack for Ethernet communication
- 8 Slot for DC 24V voltage supply
- 9 Slot for CF/SD/MMC storage medium



*Please make sure that the Touch Panel always has to be supplied with external voltage!*

2.3.2 Interfaces

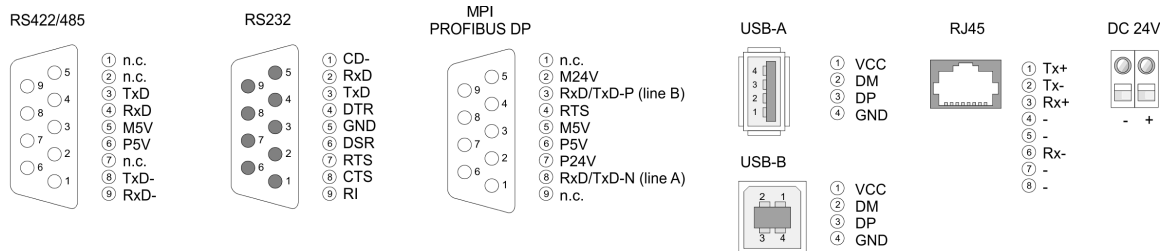

**RS422/485 interface**

*9 pin SubD jack*

- Logical states represented by voltage differences between the 4 cores
- Serial bus connection in 4-wire technology using full duplex mode
- Data communications up to a max. distance of 500m
- Data communication rate up to 115.2kBaud

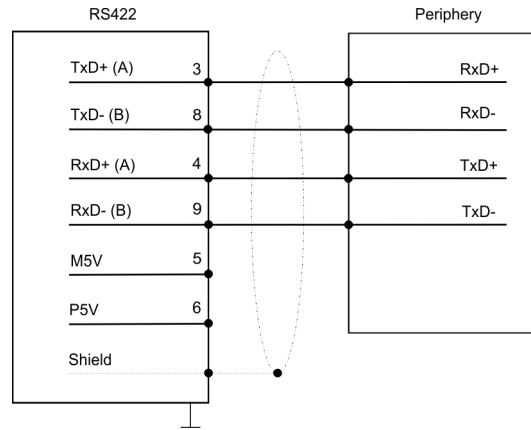

- Serial bus connection in 2-wire technology using half duplex mode

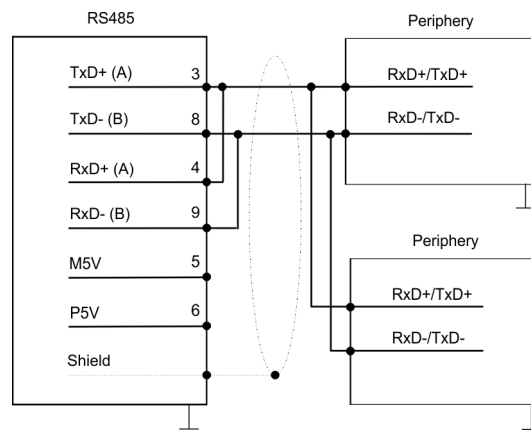

**RS232 interface**

*9 pin SubD plug*

- Interface is compatible to the COM interface of a PC
- Logical signals as voltage levels
- Point-to-point links with serial full-duplex transfer in two-wire technology up to 15m distance
- Data transfer rate up to 115.2kbit/s

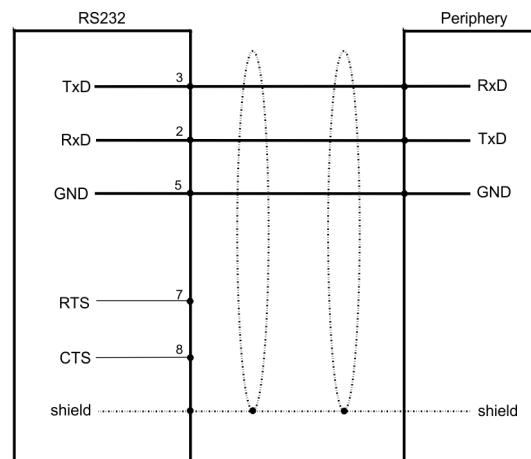

**MPI/PROFIBUS DP interface**      *9 pin SubD jack*

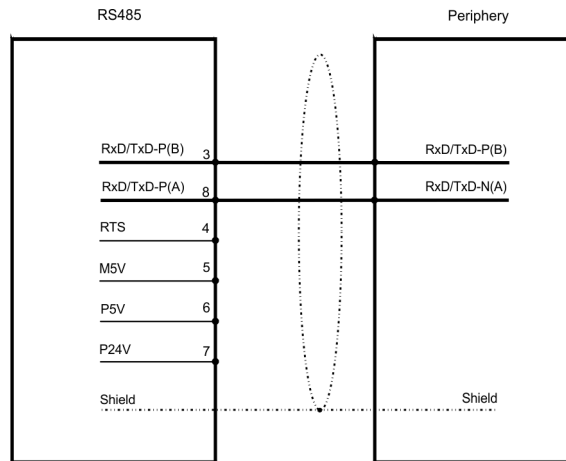

**Ethernet connection**

An RJ45 jack provides the interface to the twisted pair cable, required for Ethernet.

**"Host"-USB-A**

Using the "Host"-USB-A interface USB mouse, keyboard, stick or USB hard discs can be connected.

**"Slave"-USB-B**

For project transfer with Microsoft ActiveSync a programming cable can be connected using the "Slave"-USB-B interface. This type of transfer is only supported by Windows® XP.

The USB-A interface of your PC can be connected to the "Slave"-USB-B interface of your Touch Panel deploying the USB programming cable.

The USB programming cable is delivered by Yaskawa with order No. 670-0KB10.

**Power supply**

The Touch Panel has got an integrated power supply. The power supply has to be provided with DC 24V (20.4 ... 28.8V). For this you find an according DC 24V slot on the bottom side.

The power supply is protected against inverse polarity and overcurrent. The battery for the clock of the Touch Panel is an accumulator with a suitable charging circuit. This accumulator is maintenance-free and does not need to be exchanged within the life span of the Touch Panel.

**2.3.3 Memory management**

**Overview**

The following memory systems are available for every Touch Panel:

- 1GB work memory
- 8GB user memory (ca. 6GB for user data)
- USB storage media connected via "Host"-USB-A interface
- Slot for CF (Type II)
- Slot for MMC/SD

Please only use memory cards formatted with FAT(32)!

**Work memory**

Every Touch Panel has a work memory with a size of 1GB. The work memory is not buffered and is deleted after shut down. Please consider that also registry entries are stored in the work memory that are set back to default settings after the next re-boot. You can save them permanently by means of the *KuK Tools* (within consignment).

**User memory**

As internal permanent storage medium every Touch Panel has a flash disc with a size of 8GB (about 6GB user data). After the start of Windows® CE this memory is listed as *Flashdiskunder My Device*.

**USB storage media**

The connection of USB sticks and USB drives by use of the "Host"-USB-A interface is supported by the Touch Panel. After connection the storage media is listed as *Hard Disk* under *My Device*.

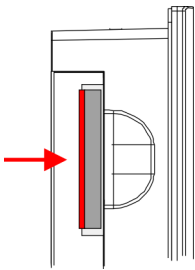
**Slot for CF**

Here you can plug a CompactFlash® type II. The card may be plugged and removed during runtime and is immediately listed as *Storage Card* at *My Device*.

Every CompactFlash® storage module has a pulling edge. Hold the CompactFlash in the way that the pulling edge points to the left side. Push the storage module without much power into the slot until the impact. To remove the card touch it at the pulling edge and pull.

**Slot for SD/MMC**

On this slot you can plug storage modules of the type SD or MMC. The card may be plugged and removed during runtime and is immediately listed as *SDMMC Card* at *My Device*. Please take care to plug the according card as shown on the back of the Touch Panel. .

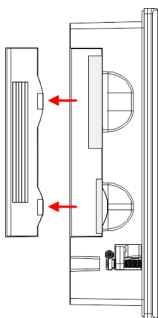
**Security flap for memory cards**

On the left side of the Touch Panel are the card slots for memory cards. The cards are visibly covered by a security flap and are thus secured from slipping out.

Please take care to pull the security flap back before plugging or pulling a memory card like shown in the illustration and put it back again afterwards. When plugging, the security flap additionally snaps into position above the plugged memory card.

## 2.4 Dimensions

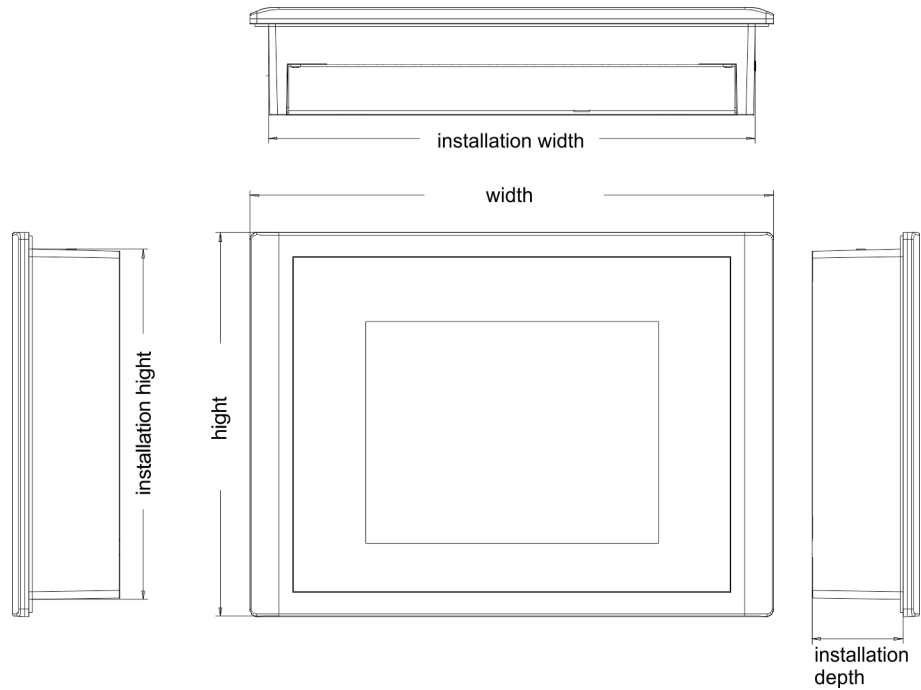

### Installation dimensions

For the installation of the Touch Panel in control cabinets and desks the following dimensions are necessary:

#### 10.4" - 62K-JJK0-EB

Front panel width	1.5 ... 6mm
Installation cutting (W x H)	287 x 217mm
Front panel (W x H)	304 x 233mm
Rear panel (W x H x D)	285 x 215 x 45mm
Installation depth	45mm



*The degrees of protection are only guaranteed when the following is observed:*

- *Material thickness at the mounting cut-out: 1.5 ... 6mm*
- *The deviation from the plane for the panel cut-out is  $\leq 0.5\text{mm}$ . This condition must be fulfilled for the mounted HMI device.*
- *Permissible surface roughness in the area of the seal:  $\leq 120\mu\text{m}$  (friction coefficient 120)*

## 2.5 General data

### Conformity and approval

Conformity		
CE	2014/30/EU	EMC directive
Approval		
UL		Refer to Technical data
others		
RoHS	2011/65/EU	Restriction of the use of certain hazardous substances in electrical and electronic equipment

### Protection of persons and device protection

Type of protection	-	IP20
Electrical isolation		
to the field bus	-	electrically isolated
to the process level	-	electrically isolated
Insulation resistance		-
Insulation voltage to reference earth		
Inputs / outputs	-	AC / DC 50V, test voltage AC 500V
Protective measures	-	against short circuit

### Environmental conditions to EN 61131-2

Climatic		
Storage / transport	EN 60068-2-14	-20...+60°C
Operation		
Horizontal installation	EN 61131-2	0...+50°C
Vertical installation	EN 61131-2	0...+50°C
Air humidity	EN 60068-2-30	RH1 (without condensation, rel. humidity 10...95%)
Pollution	EN 61131-2	Degree of pollution 2
Mechanical		
Oscillation	EN 60068-2-6	1g, 9Hz ... 150Hz
Shock	EN 60068-2-27	15g, 11ms

### Mounting conditions

Mounting place	-	In the control cabinet
Mounting position	-	Horizontal and vertical

Use in difficult operating conditions

EMC	Standard	Comment	
Emitted interference	EN 61000-6-4	Class A (Industrial area)	
Noise immunity zone B	EN 61000-6-2	Industrial area	
		EN 61000-4-2	ESD 8kV at air discharge (degree of severity 3), 4kV at contact discharge (degree of severity 2)
		EN 61000-4-3	HF field immunity (casing) 80MHz ... 1000MHz, 10V/m, 80% AM (1kHz) 1.4GHz ... 2.0GHz, 3V/m, 80% AM (1kHz) 2GHz ... 2.7GHz, 1V/m, 80% AM (1kHz)
		EN 61000-4-6	HF conducted 150kHz ... 80MHz, 10V, 80% AM (1kHz)
		EN 61000-4-4	Burst, degree of severity 3
		EN 61000-4-5	Surge, degree of severity 3 <sup>1</sup>

1) Due to the high-energetic single pulses with Surge an appropriate external protective circuit with lightning protection elements like conductors for lightning and overvoltage is necessary.

## 2.6 Use in difficult operating conditions



*Without additional protective measures, the products must not be used in locations with difficult operating conditions; e.g. due to:*

- *dust generation*
- *chemically active substances (corrosive vapors or gases)*
- *strong electric or magnetic fields*



## 2.7 Technical data

### 2.7.1 62K-JKK0-EB

Order no.	62K-JJK0-EB
Type	Touch Panel TP 610C
<b>Display</b>	
Display size (diagonal)	10.4 "
Display size (width)	211.2 mm
Display size (height)	158.4 mm
Resolution	600 x 800 / 800 x 600
Aspect ratio	4:3
Type of display	TFT color (16.7M colors)
MTBF Backlights (25°C)	50000 h
<b>System properties</b>	
Processor	ARM Cortex A9 800MHz
Operating system	Windows Embedded Compact 7
User software	Movicon 11 CE Standard
Work memory	1 GB
User memory	8 GB
Available memory (user data)	6 GB
SD/MMC Slot	✓
CF Card Slot Typ II	✓
CFast Slot	-
<b>Time</b>	
Real-time clock buffered	✓
Clock buffered period (min.)	6 w
Type of buffering	Vanadium Rechargeable Lithium Battery
Load time for 50% buffering period	10 h
Load time for 100% buffering period	48 h
Accuracy (max. deviation per day)	10 s
<b>Operating controls</b>	
Touchscreen	resistive
Touch function	Single Touch
Keyboard	external via USB
Mouse	external via USB
<b>Interfaces</b>	
MPI, PROFIBUS-DP	RS485 isolated
MPI, PROFIBUS-DP connector	Sub-D, 9-pin, female

Technical data &gt; 62K-JJK0-EB

Order no.	62K-JJK0-EB
Serial, COM1	RS232
COM1 connector	Sub-D, 9-pin, male
Serial, COM2	RS422/485 isolated
COM2 connector	Sub-D, 9-pin, female
Number of USB-A interfaces	2
USB-A connector	USB-A (host)
Number of USB-B interfaces	1
USB-B connector	USB-B (device)
Number of ethernet interfaces	2
Ethernet	Ethernet 10/100 MBit
Ethernet connector	RJ45
Integrated ethernet switch	✓
Video connectors	-
Audio connections	-
<b>Technical data power supply</b>	
Power supply (rated value)	DC 24 V
Power supply (permitted range)	DC 20.4...28.8 V
Reverse polarity protection	✓
Current consumption (no-load operation)	0.2 A
Current consumption (rated value)	0.35 A
Inrush current	1.84 A
$I^2t$	0.05 A <sup>2</sup> s
Power loss	8.5 W
<b>Status information, alarms, diagnostics</b>	
Status display	green LED
Supply voltage display	yes
<b>Mechanical data</b>	
<b>Housing / Protection class</b>	
Material	die-cast aluminum
Mounting	via integrated pivoted lever
Protection class IP front side	IP 65
Protection class IP back side	IP 20
Protection class NEMA front side	-
Protection class NEMA back side	-
<b>Dimensions</b>	
Front panel	304 mm x 233 mm x 7.5 mm

<b>Order no.</b>	<b>62K-JJK0-EB</b>
Rear panel	285 mm x 215 mm x 45 mm
<b>Installation cut-out</b>	
Width	287 mm
Height	217 mm
Minimum	1.5 mm
Maximum front panel thickness	6 mm
Net weight	2850 g
Weight including accessories	3650 g
Gross weight	3650 g
<b>Environmental conditions</b>	
Operating temperature	0 °C to 50 °C
Storage temperature	-25 °C to 70 °C
<b>Certifications</b>	
UL certification	in preparation
KC certification	-

## 3 Deployment Touch Panel

### 3.1 Installation

#### Overview

The Touch Panel is suitable for the installation in operating tables and control cabinet fronts. The installation happens via the back. The Touch Panel is provided with a patented integrated fixing technique that allows an easy connection with a simple screwdriver.

Due to the fact that the Touch Panel has a plug connector for bus connection and voltage supply, a fast and easy device change is possible.

#### Installation cutting

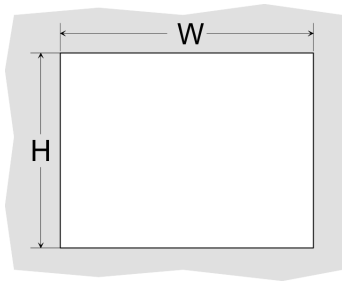

For the installation into a operating tableau and control cabinet fronts, the Touch Panel requires the following front plate cutting:

Touch Panel	W x H in mm
62K-JJK0-EB	287 x 217

#### Installation

The fixing technique is integrated in the casing of the Touch Panel and accessible via the back. For the installation, a small slit screwdriver is required

1. ➤ Push the operator panel [3] from the front side into the front panel cutting [1] until it touches the panel with the seal [2].
2. ➤ Now bolt the lever [5] clockwise with the screwdriver [4] until it rotates to the outside.
3. ➤ Further screwing bolts the lever to the front panel until it holds this to the control cabinet front.

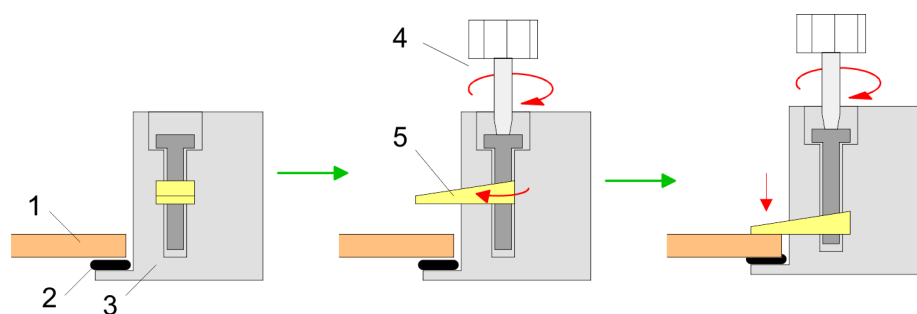

## Connect power supply

For the cabling of the DC 24V power supply green plugs with CageClamp technology are deployed. The spring-clip connector technology simplifies the wiring requirements for signaling and power cables. In contrast to screw terminal connections, spring-clip wiring is vibration proof.

Here also you can connect wires with a cross-section of  $0.08\text{mm}^2$  to  $2.5\text{mm}^2$ . You can use flexible wires without end case as well as stiff wires.

Fix the conductors to the CageClamps like this:

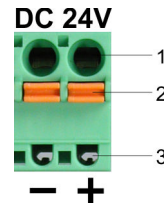

- 1 Round opening for wires
- 2 Locking (orange) for screwdriver
- 3 Test point for 2mm test tip

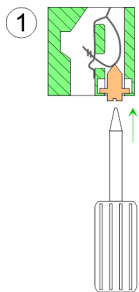

The picture on the left side shows the cabling step by step from top view.

1. ➤ For cabling you push the locking vertical to the inside with a suitable screwdriver and hold the screwdriver in this position.
2. ➤ Insert the insulation-stripped wire into the round opening. You can use wires with a cross-section from  $0.08\text{mm}^2$  to  $2.5\text{mm}^2$ .
3. ➤ By removing the screwdriver the wire is connected safely with the plug connector via a spring.

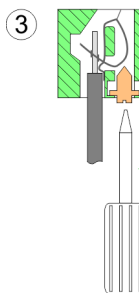
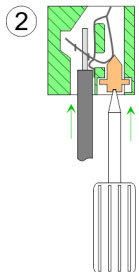

## 3.2 Commissioning



### CAUTION!

- Before commissioning the device must be brought to room temperature.
- At condensation the device must be absolutely dry before connected to power.
- To avoid overheat during operation the device must not be laid open to direct sun light.
- After opening the control cabinet or desk, there are parts with possible dangerous voltage available.
- For all signal connections only screened cables are permitted.
- Signal cables must not be let within the same cable shaft as high voltage cables.



### CAUTION!

When changing the '*Regional Settings*', please note that only *English* and *German* are supported, other languages can lead to a system crash.

### 3.2.1 Startup-Manager

#### Start screen

As soon as the Touch Panel is provided by power supply, the *Startup-Manager* will be loaded. At the first startup of the *Startup-Manager* the following *start screen* appears.

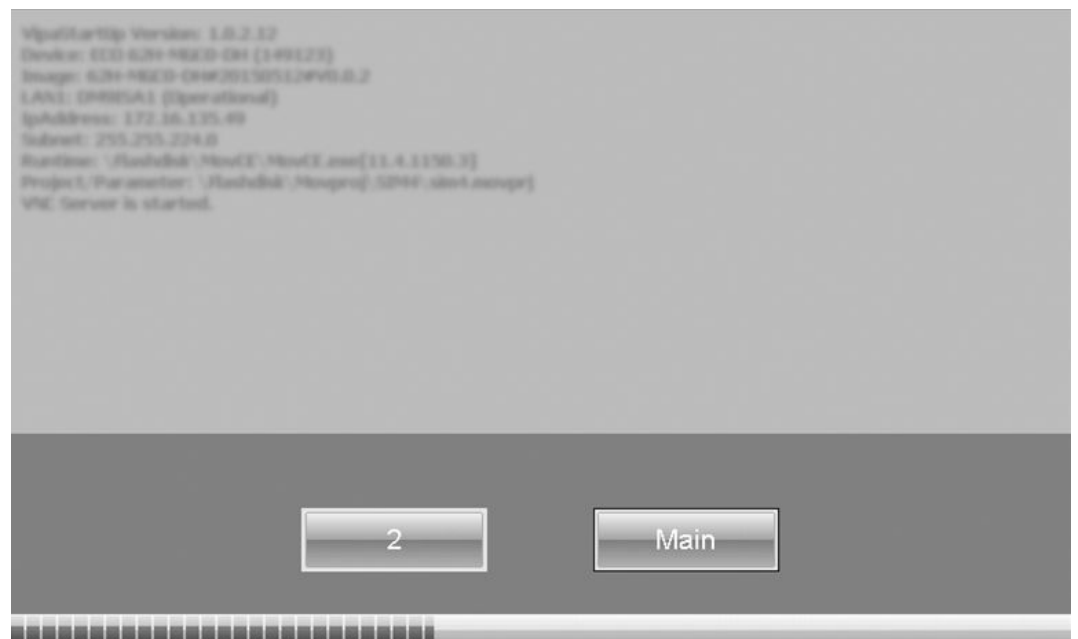

- There is a button on the *initial screen* with a counter, which counts backwards. If you click on this button within this time, the project will start. If the time expires, the project will start automatically. With the button '*Main*' you get to the *selection menu*.
- A delay time of 5 seconds is default. In the *selection menu* under "Autostart" you can adjust this time.

**Selection menu**

There are following buttons in the *selection menu*:

- Settings
- Info/Update
- Autostart
- Backup
- Exit
- Back

**Settings**

- In [Settings] under *Change Settings* you can set a password for the *Startup-Manager*. The password will be requested when interrupting the start countdown or before closing the Startup-Managers by "Exit". By default, no password is defined.
- In *Control Panel* [Open...] the system settings like brightness of the display can be preset or the display can be re-calibrated. Here the MPI/DP slave interface may also be configured. Further you get here the Touch Panel information: product number, serial number and licenses.

**Info/Update (firmware)**

- To execute the firmware update press the button [Info/Update]. After clicking on [Info/Update] the current image is displayed under "Panel Information" with panel name, creation date and version number.
- With [Create Screenshot] you can make a screen shot of the panel information and select a destination for its storage.
- With [Search Image] a list of all the firmware images is shown, which are available on the Touch Panel and connected storage media. These images will be listed with create data and version number. Choose your new image.

If the selected image is not correct for your Touch Panel, an error message will appear. If the image is correct for your Touch Panel, in the following message the current installed image version and the new selected image version will be listed.

1. ➤ Close all processes (e.g. Movicon, Movicon TCP UploadServer).



*Make sure that the 'TCP UploadServer' has ended because otherwise the update of the image will fail. There are two ways to do this:*

- *In the Startup-Manager uncheck 'Movicon TCP Uploadserver' and restart the Panel.  
Just removing the tick does not end the program!*
- *Close the program via the task manager under 'Flashdisk → Tools'.*

2. ➤ Click on [Update Image] to execute the update. This can take a few seconds.
3. ➤ Confirm the successful update in the next window with [Finish].
  - ⇒ After successful update the Touch Panel restarts.
  - After the restart the calibration window opens.
4. ➤ Re-calibrate the Touch Panel as described. After calibration tap anywhere on the screen.
  - ⇒ The calibration window closes.



*To permanently retain the settings, you have to store them under 'Start → Programs → KuK\_Tools → KuK Tools' [Store].*

**Autostart**

With [Autostart] you define which runtime and which project will be started automatically together with the Touch Panel startup.

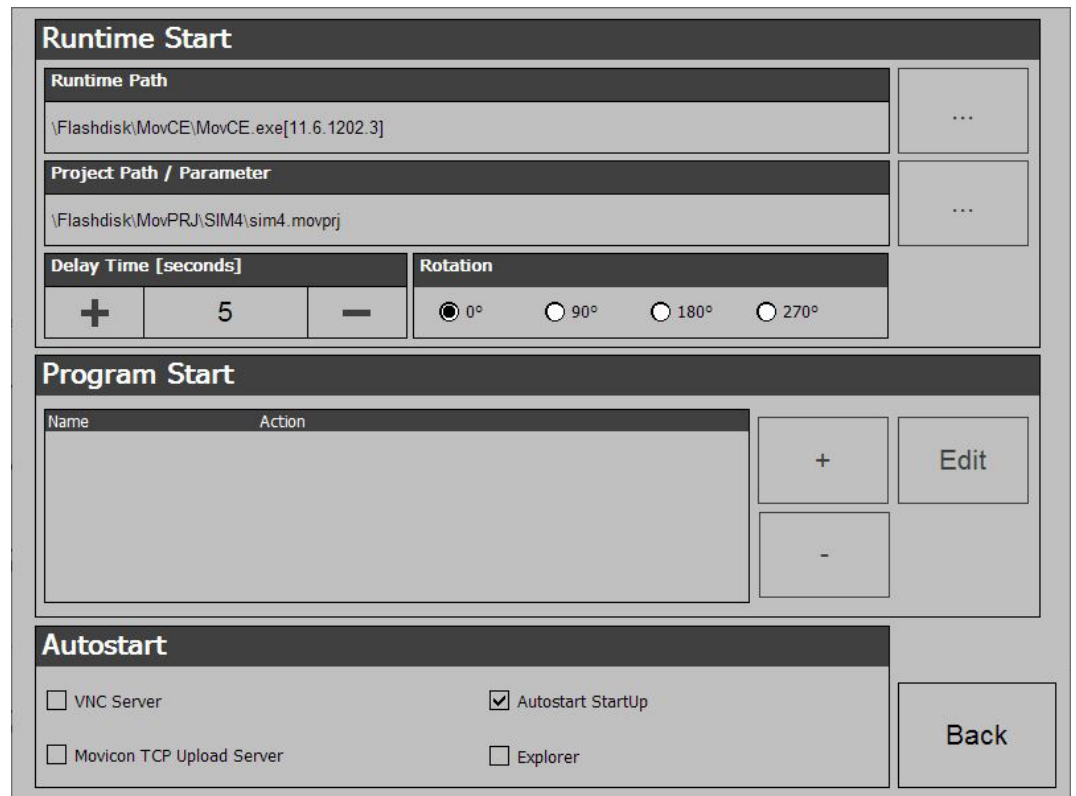

- With [...] under "Runtime path" res. "Project path" all existing runtimes res. projects on the Touch Panel and the storage media are listed.
- If the Touch Panel should start with a project of the web visualization of the SPEED7 Studio, you have to select a batch file with [...] under "Runtime path" *'Enter manually → Flashdisk'*. For this, select under "Type" *all Files* and select one of the following batch files:
  - Start VIPA Webbrowser.bat
  - Start VIPA Webserver and Browser fullscreen.bat
  - Start VIPA Webserver and Browser.bat
  - Start VIPA Webserver.bat
- Under "Delay Time" you can adjust a delay time > 0 by using the buttons [+] and [-]. 5 seconds are default.
- Via "Rotation" the orientation of the Touch Panel can be changed.

Via "Program start" with [+] you can add programmes, which have to start automatically.



1. ➤ Select "start" and assign a name for the program.



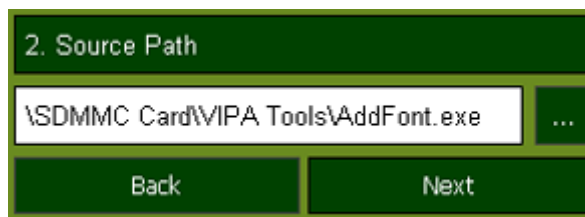

2. ➤ Upload your program with [...].

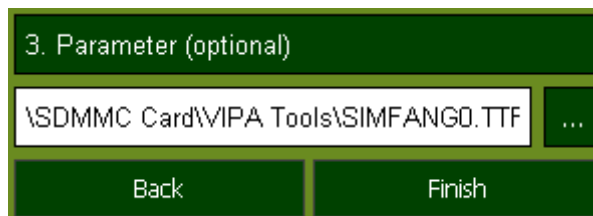

3. ➤ You can optionally set parameters.

4. ➤ Exit with [Finish].

- With "Copy" [...] you can copy Windows® CE files on the Touch Panel from a source path to a destination path.
- With "Autostart" you can select the automatic startup of the *VNC server*, the *Movicon-TCP upload server*, the *Startup-Manager* resp. the *Explorer*. With [Back] you get back to the *select menu*.

### **Backup**

By default, the configuration of the *Startup-Manager*, the registry settings for the back-light, the local settings and the LAN settings will be saved by [Backup] in '*Flashdisk* ➔ *Backup*'. The name of the backup file is "backup.bkv". Which settings will be saved and the storage location are defined in the file "ToDoList.xml" under '*Flashdisk* ➔ *Startup*'. These can be adjusted accordingly.

### **Exit**

The *Startup-Manager* will be closed by [Exit] and the system returns to the Windows® screen.

### **Back**

With [Back] you get back to the start screen of the *Startup-Manager*.

### 3.3 Connection to a PLC system

#### 3.3.1 Overview

For the inclusion into your PLC system several HMI/SCADA project-engineering platforms are at your disposal that has to be installed at an external PC. Here you may create your project, where appropriate simulate it and transfer it to the Touch Panel via a connection that you've entered before. Via the at the Touch Panel pre-installed runtime version of the HMI/SCADA project engineering platforms your project is run able.

By using the according communication driver, the Touch Panel supports connecting options to the PLC via field bus and Ethernet.

During operation your operating device communicates with the according PLC and reacts to the application courses in the PLC according to the configured processes. Via dialogues configured before, process values may be monitored graphically, altered and evaluated.

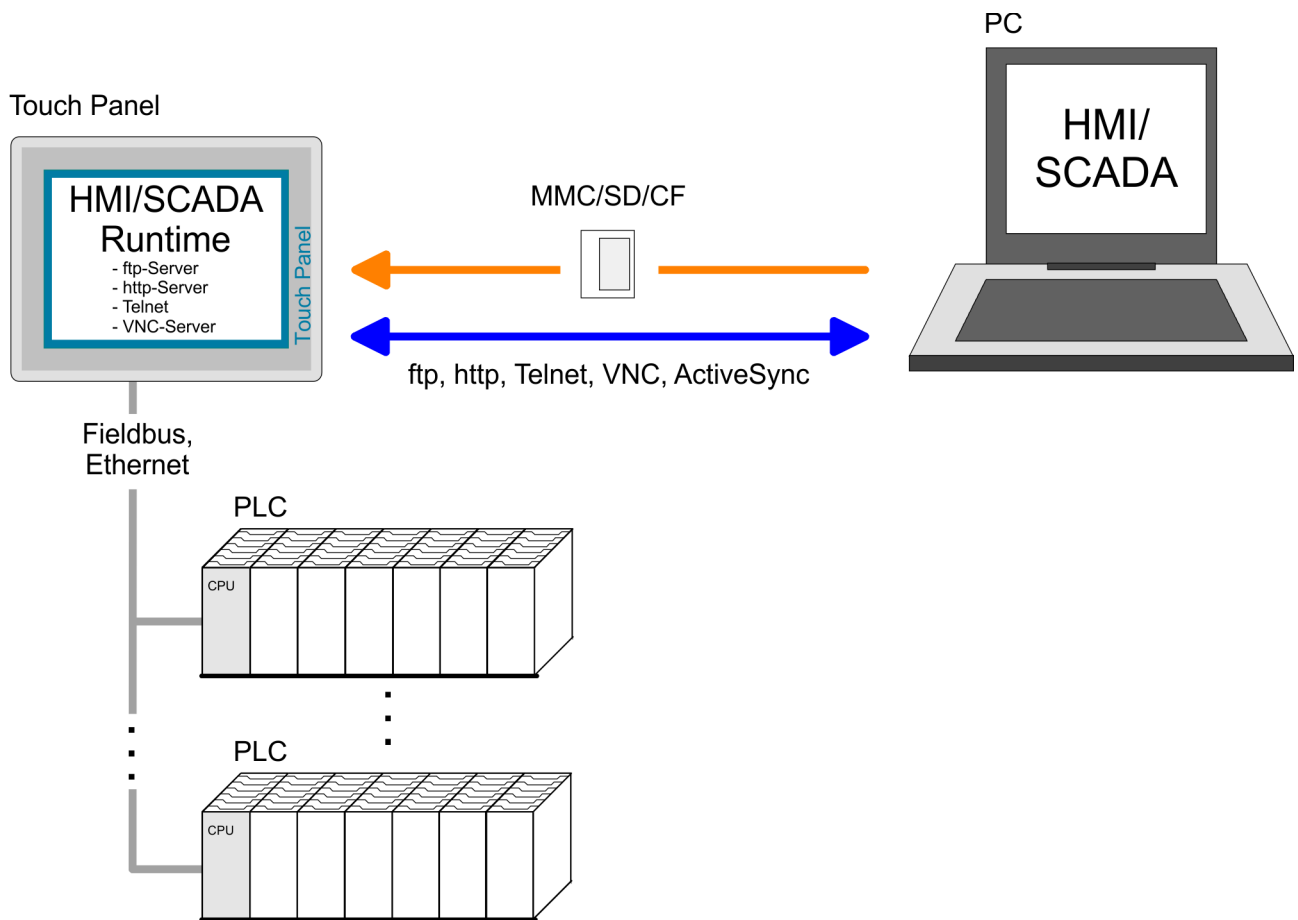

#### 3.3.2 Integrated server

##### 3.3.2.1 General

###### Login data

The Touch Panel has several integrated server that enable a remote maintenance within a network. Some servers only allow access by means of entering *User name* and *Password*. The following login data are used standardly:

User name: **wince**

Password: **vipatp**

###### Overview

Per default the following server are integrated:

- ftp server (activated)
- Telnet (activated)
- VNC (not activated)
- Web server (activated)

<b>Phrases</b>	Phrases that are used in the description of the server:
<b>Client</b>	A client is an application that uses the service of a server within a network. For example, a web browser is a client because at every call of a website it sends a request to a web server and receives an answer.
<b>Server</b>	A server is an application that waits for the contact request of a client application and exchanges messages with it after contact start. This communication type is called Client-Server communication.
<b>Host</b>	Computer within a network where at least one server is running.
<b>Download</b>	Data transfer Server → Client
<b>Upload</b>	Data transfer Client → Server

### 3.3.2.2 ftp server

By means of a ftp server data between client and server can be exchanged. Here you can copy, delete or create files and directories.

#### Conditions for ftp access

Depending on the ftp client your PC must have the following conditions for a ftp connection. If there are still problems with the ftp access please ask your system administrator.

Internet Explorer

- ftp access possible with version 5.5 or higher
- activate directory view for ftp sites

For the adjustment choose in the Internet Explorer '*Options* → *Internet options*', register "extended" in the area "Browsing" and set the following settings:

1. ➤ activate: "activate directory view for ftp sites"
2. ➤ Restart the Internet Explorer.
  - ⇒ The settings are saved.

#### Establishing a ftp connection

Below is explained, how to establish of a ftp connection between a Windows® based PC with Windows Explorer as ftp client and your Touch Panel.

1. ➤ Connect your Touch Panel with the network where your PC is a member via an Ethernet cable.
2. ➤ Switch on your Touch Panel.

3. ➤ As soon as your Touch Panel is connected via Ethernet, you can monitor the IP address data via  in the taskbar.

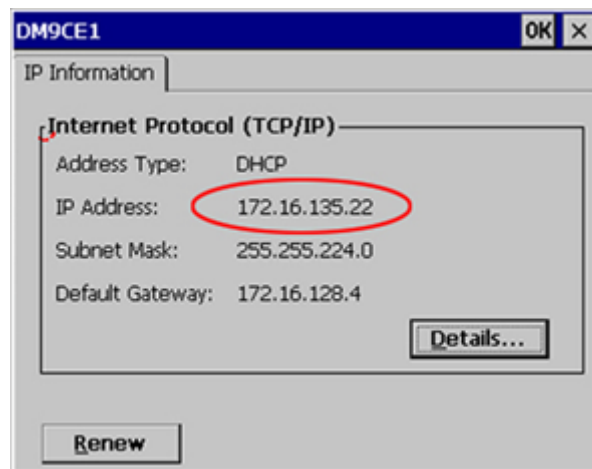

4. ➤ After you've confirmed the pre-settings, start your ftp client (e.g. Windows Explorer) and enter the following text into the "address bar":

```
ftp://wince:VIPATP@IP-Adresse
```

- ⇒ In the appearing explorer window you can execute the requested file operations.

### 3.3.2.3 Telnet server

Telnet is a text based client-server protocol on TCP level. Using of a Telnet client like e.g. the "MS-DOS console" in your Windows® operating system you may execute text based all file remote functions at your Touch Panel like copy, delete and create files and directories. You can also start applications. Terminating an application is not possible.

#### Establishing a Telnet connection

The establishing of a Telnet connection is password protected and has the following approach:

1. ➤ Start a Telnet client like for example "MS-DOS console" at your PC and enter the following into the address bar: `telnet IP address`.
- ⇒ When the connection is established, the Touch Panel asks for the user name and the password.

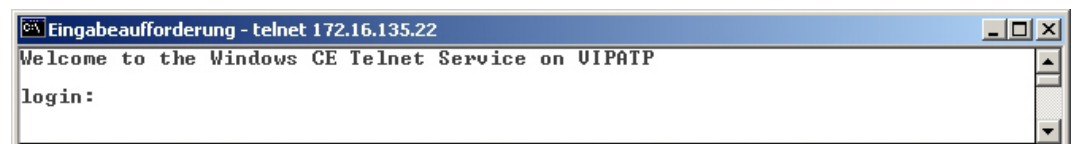

2. Enter the following:

Login: **wince**

Password: **vipatp** (entry is hidden)

⇒ After entering valid user data a command line for entries appears:

```

C:\> Eingabeaufforderung - telnet 172.16.135.22
Welcome to the Windows CE Telnet Service on VIPATP

login: wince
Password:

Pocket CMD v 5.0
\>
  
```

By entering `Exit` res. closing the window you can terminate the Telnet connection at any time.

## Commands

After establishment of a Telnet connection the Touch Panel provides you with commands. A list of possible commands with a short description is available via the command help. By beginning with "help" before a command you receive help to this command.

```

C:\> Eingabeaufforderung - telnet 172.16.135.22

Pocket CMD v 5.0
\> help
The following commands are available:
    ATTRIB  Set/display file attributes.
    CALL    Call batch script.
    CD      Change directory.
    CHDIR   Same as CD.
    CLS     Clear the screen.
    COPY    Copy files.
    DATE    Display/set system date.
    DEL     Delete a file.
    DIR     Print contents of a directory.
    ECHO    Echo output on the screen or change echoing parameters.
    ERASE   Same as DEL.
    EXIT    Exit command interpreter.
    HELP    Print help for command interpreter or individual commands.
    GOTO    Transfer control to a label in batch processing.
    IF      Conditionally execute a command.
    MD      Create a directory.
    MKDIR   Same as MD.
    MOVE    Move/rename files.
    PATH    Alias for SET PATH.
    PAUSE   Suspend execution of a batch file.
    PROMPT  Reconfigure system prompt.
    PWD     Print current working directory.
    RD      Remove directory.
    REM     Record comments in batch file.
    REN     Change file name.
    RENAME  Same as REN.
    RMDIR   Same as RD.
    SET     Set or list environment variables.
    SHIFT   Shift arguments of a batch file.
    START   Start detached process.
    TIME    Display/change system time.
    TITLE   Set the window title for a CMD.EXE session.
    TYPE    Output contents of a file or files to the screen.
Use HELP [command name] to display extended help for given command, or
HELP CMD to display help on general topics such as
command input options, I/O redirection or CMD parameters.
\> -
  
```

3.3.2.4 VNC server

The Touch Panel has an integrated VNC server (virtual network control) that allows the total control of the Touch Panel with a PC via network. For this, a window displays the current Touch Panel content for remote control. Operation is performed via PC keyboard and mouse. Condition for the VNC communication is, that the VNC server is started on the Touch Panel and a VNC client on the PC. You can download a VNC client as free-ware from internet.

**i** *Because you can deactivate all safety attitudes with the VNC server, you should use these exclusively for start-up! For this reason the VNC server is on delivery deactivated.*

*Due to software reasons Yaskawa does not support the VNC server function!*

**Establishing a VNC connection**

The VNC connection establishment has the following approach:

1. Start the VNC server via 'Start → Programs → Tools → winvnc' or activate the VNC server in the Startup-Manager under "Autostart".
  - ⇒ To show the server has been started, the symbol  $E_{fon}$  vnc appears in the task bar.
2. Now start the VNC client vncviewer.exe on your PC.

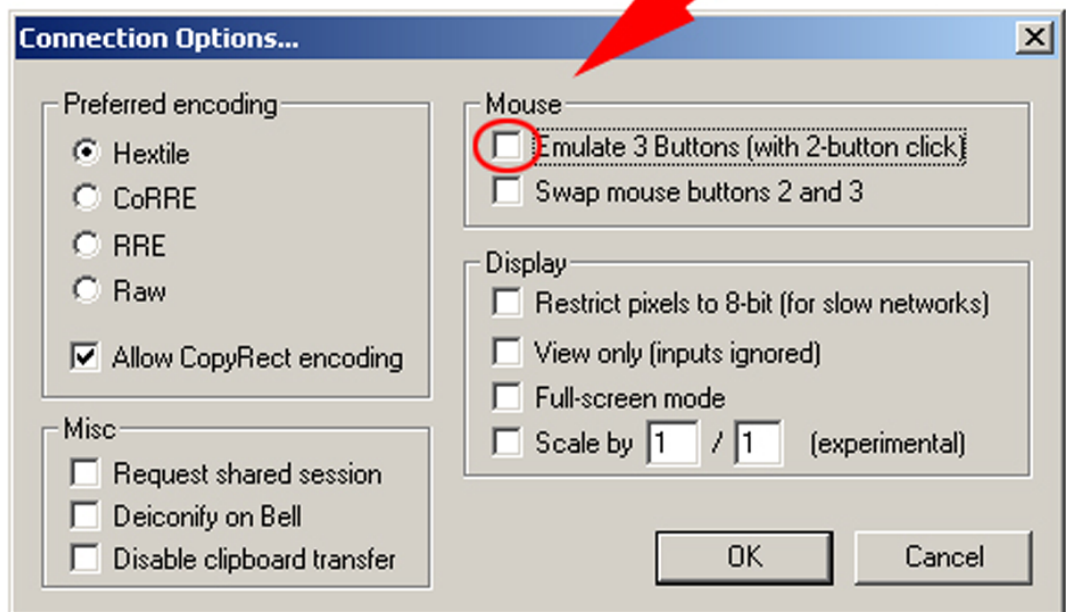
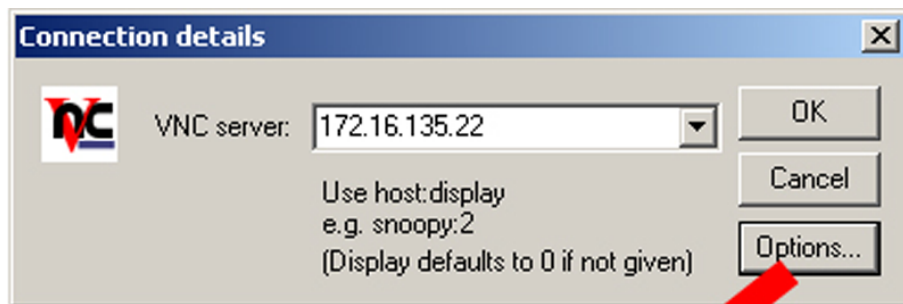

3. Click on [Options] and deactivate the field "Emulate 3 Buttons..." like shown at Mouse.

4. ➤ Enter the IP address of the Touch Panel at VNC server. Click on [OK] and enter the password vipatp. You can change the password over the configuration file, for this execute vncconfig.exe. Now a VNC connection is established and the screen content of the Touch Panel is monitored within a window.

Closing the VNC window terminates the VNC connection, the server keeps running.

### 3.3.2.5 Web server

The Touch Panel has an integrated web server that allows depending on the access the administration of the Touch Panel res. of websites in the Touch Panel. The administrative access to the http server happens via Ethernet from the PC by setting the IP address of the Touch Panel with attached "Admin" type.

Using the websites you may e.g. publish online documentations for a connected PC or go online with applications on the PC.

### Web admin

As web admin you have access to all functions that are required for uploading and administrating of websites on the Touch Panel. Additionally you may set the access rights for user and create user groups. More detailed information about creating and administrating of websites on the Touch Panel are available in the online documentation of the web servers.

The login as web admin requires the following steps:

1. ➤ Start the web browser at your PC and enter the following into the address bar: IP address/webadmin
2. ➤ Enter the following into the authentication:
  - User name: **wince**
  - Password: **vipatp**

## 3.3.3 Communication via ActiveSync

### Overview

ActiveSync is a communication platform developed by Microsoft especially for mobile computers to synchronize data between a mobile device and a PC via USB. Many developer tools res. SCADA project-engineering tools use ActiveSync for the data transfer. Before you can access the Touch Panel from the PC via ActiveSync you have to install it on the PC. ActiveSync is freeware and can be downloaded from [www.microsoft.de](http://www.microsoft.de).



*Please note that this type of transfer is only supported by Windows® XP.*

### Installation

1. ➤ Download the ActiveSync from the Microsoft website and start the file MSA-SYNC.EXE.
2. ➤ Start the installation with [Next].
3. ➤ Choose an installation directory and click on [Next].
  - ⇒ ActiveSync is installed.

**Install USB communication**

After the installation the dialog window "establish connection" is opened.

1. ➤ Start the search run with [Next].
2. ➤ Connect your Touch Panel via the "Device"-USB-B jack to your PC and turn on the Touch Panel.
  - ⇒ The USB device (Touch Panel) is recognized and the dialog window "new partnership" opens.
3. ➤ Choose "yes" for fixing a partnership and push [Next].
4. ➤ In the opening window de-activate all synchronization settings and click on [Next].

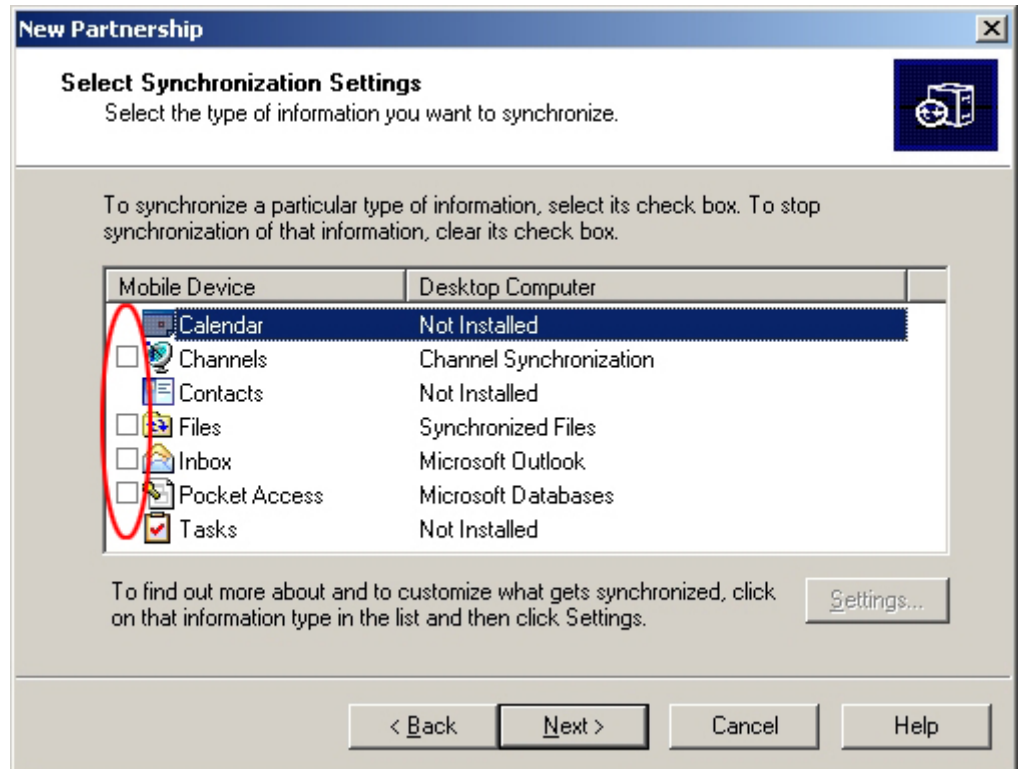

5. ➤ [Finish] establishes the partnership.

Now you can access the Touch Panel with ActiveSync via USB.



*To keep the settings also after power on, you have to store them to the registry with 'START → Programs → KuK\_Tools → KuK Tools' [Store].*



## 3.4 Operating system Windows Embedded Compact 7

### 3.4.1 General

#### Features

- File viewer for Word, Excel, PowerPoint and PDF
- ftp, Telnet, VNC and Web server
- RDP (Remote Desktop Protocol)
- ActiveSync file transfer (USB, RS232)
- Internet Explorer
- Registry Editor
- WordPad
- USB keyboard driver
- HP printer driver (COM, Ethernet, USB)
- Startup-Manager

#### Differences to the standard Windows® operation

Please regard that for the deployment of WEC7 a thorough knowledge of operating Windows® are assumed. Here are only shown the differences to a "standard" Windows® operating system.

#### Pen entry

You're operating the Touch Panel by means of a pencil for capacitive touch screen res. with the finger. The following types of entry are differentiated:

- *Double click*  
A double click has to be executed like mouse operation by touching the area on the screen twice. A double click on an object opens res. executes this.
- *Drag*  
By tapping on an object and then dragging you can move the object on the screen. If no object is selected, a frame is created by the dragging that selects the touched objects.

#### Navigation within the dialog window

The windows can be moved via the head bar. Here you can also find the [OK] button to confirm entries and the [X] button for exiting the dialog.

#### Exit WEC7 (shut down)

You can not exit WEC7. By switching the power supply off and on again you can restart WEC7. Before a reboot you should always save your data res. close all running applications to avoid data loss.



*Please note that changes made are set back after PowerOFF-PowerON and are only stored via 'Start → Programs → KuK\_Tools → KuK Tools' [Store].*

### 3.4.2 Structure

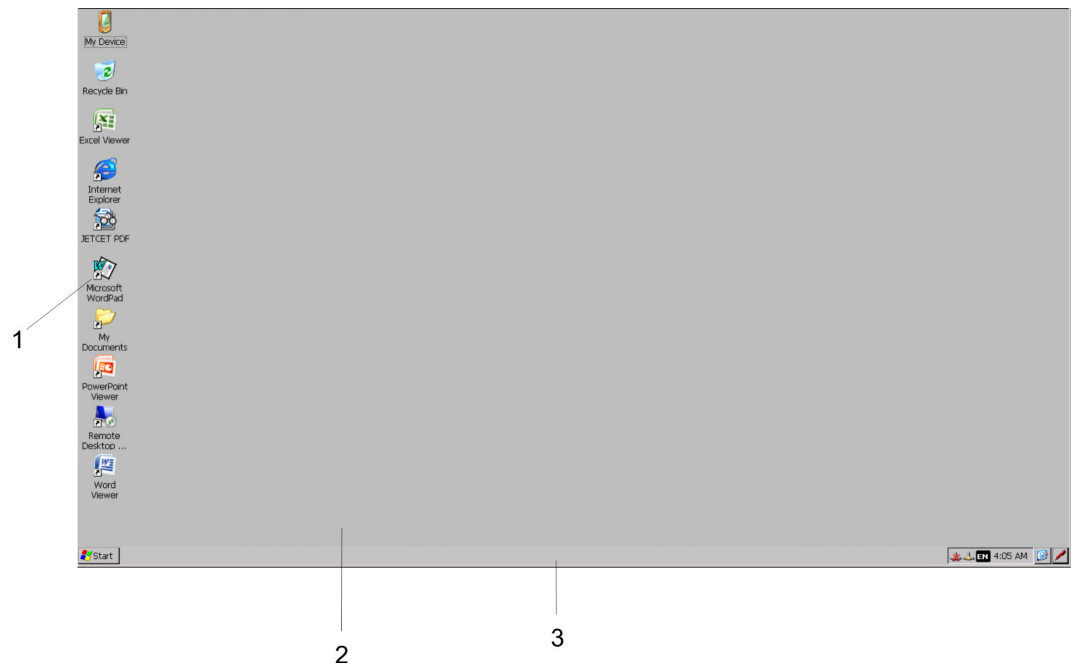

1	<i>Icon</i>	Via icons on the desktop you gain direct access to the application related to the icon.
2	<i>Desktop</i>	The desktop is the screen that is shown after login to Windows <sup>®</sup> . It contains e.g. links to the mostly used applications res. system components.
3	<i>Task bar</i>	The task bar is part of the desktop. When opening an application, a document or a window, every running object is displayed as button on the task bar. Via this buttons you can easily change between the open windows.

#### Task bar

Basically the taskbar has the following structure:



1	<i>Start button</i>	This button offers you access to all components of your Touch Panel such as applications, system settings, file browser etc.
2	<i>Open applications</i>	For every open application a button can be found in the task bar. There is no button for minimizing. The switch between the applications is performed via this buttons.
3	<i>Network connection</i>	As soon as your Touch Panel is connected via Ethernet you can see here the Ethernet address. If there is no connection via Ethernet, the symbol is displayed crossed out.
4	<i>Keyboard layout</i>	If you've connected a keyboard you can choose the requested language layout via this button.
5	<i>Time</i>	This area shows the time that you can change via double click.

6	Show desktop	All windows are minimized and the desktop is shown.
7	Software keyboard	This button displays a keyboard at the screen. "Hide Input Panel" hides the keyboard again.

**Software keyboard**

The button  allows you to select one of the available software keyboards. At the moment the following standard keyboards are implemented:

**Keyboard**

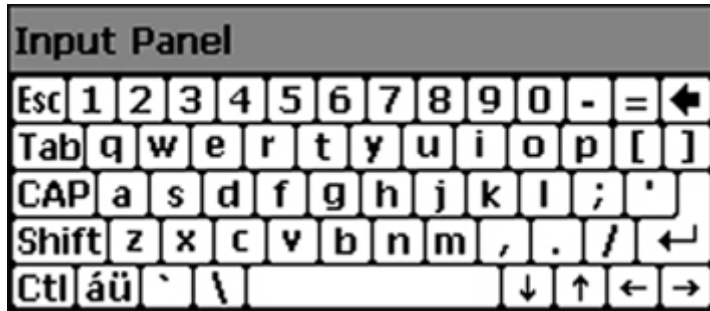

At pushed Shift key:

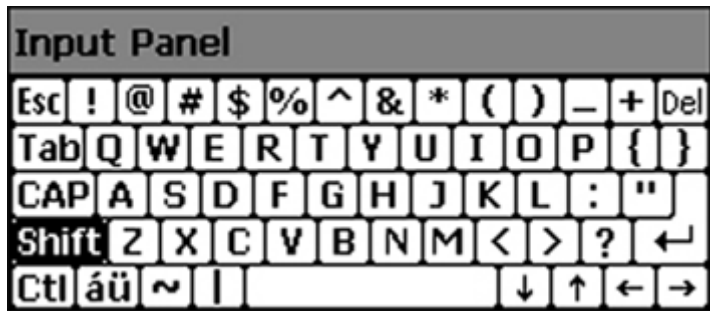

At pushed [a´ü] key:

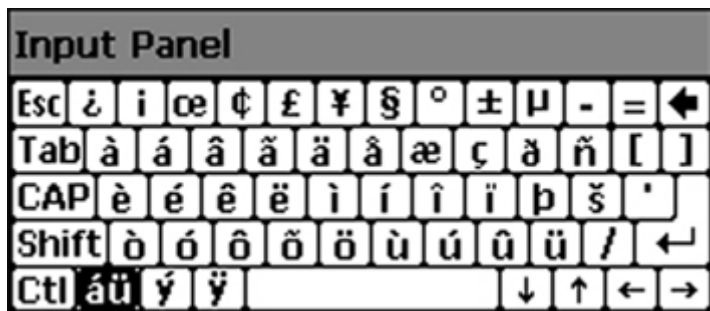

Please note that äöü can exclusively be entered via the software keyboard "Keyboard".

**Large Keyboard**

Input Panel															
Esc	F1	F2	F3	F4	F5	F6	F7	F8	F9	F10	F11	F12	Home	End	Prop
`	1	2	3	4	5	6	7	8	9	0	-	=	BS		
Tab	q	w	e	r	t	y	u	i	o	p	[	]	\		
Caps Lock	a	s	d	f	g	h	j	k	l	;	'		return		
Shift	z	x	c	v	b	n	m	,	.	/	up		pgup		
Ctrl	win	Alt							ins	del	lt	dn	rt	pgdn	

At pushed Shift key:

Input Panel															
Esc	F1	F2	F3	F4	F5	F6	F7	F8	F9	F10	F11	F12	Home	End	Prop
~	!	@	#	\$	%	^	&	*	(	)	_	+	BS		
Tab	Q	W	E	R	T	Y	U	I	O	P	{	}			
Caps Lock	A	S	D	F	G	H	J	K	L	:	"		return		
Shift	Z	X	C	V	B	N	M	<	>	?	up		pgup		
Ctrl	win	Alt							ins	del	lt	dn	rt	pgdn	

- Home      Position 1
- End        End
- BS         Backspace
- up         ↑
- dn         ↓
- lt         ←
- rt         →
- pgup      Page↑
- pgdn      Page↓
- ins        Insert
- del        Delete
- Tab        Tabulator
- Shift
- Caps/Lock

**Hide keyboard**

The software keyboard allows you to enter key entries without connecting an external keyboard. As soon as an entry is required the software keyboard is automatically shown. *Hide Input Panel* hides the keyboard again.

**System setting (Control Panel)**

As many components of the *Control Panel* conform with the *System Control* of Windows®, most of the description is not necessary. The description of the control panel components relevant for operating the Touch Panel can be found in the following:

- *Set Display*  
Via 'Start → Settings → Control Panel → Display' the dialog windows for the display properties opens. Here you can change the settings for the monitor options.
- *Calibrate touch screen*  
If the touch screen does not always react to a double click or not precisely recognize the position of an entry, you can call the dialog *Stylus* via 'Start → Settings → Control Panel'. In the register *Double-Tap* you can use the grid pattern to preset a double click velocity and test this on the symbol below. Click [OK] to accept the value. The calibration of the touch screens is completed via the register *Calibration* by following the instructions.

- **Set Ethernet Parameters**  
The dialog field for pre-setting an Ethernet address can be found in 'Start → Settings → Network and Dial-up Connections'. The default setting is address assignment via DHCP.
- **System Properties (System)**  
Via 'Start → Settings → Control Panel → System' you receive information about the version of the current Windows® operating system, the memory load and sharing (alterations here are not accepted into the registry) and the copyright. The register 'Device Name' allows you to change the device name that is shown during Ethernet communication for instance.
- **Regional Settings**  
Via 'Start → Settings → Control Panel → Regional Settings' you can adjust the regional settings for the display of date, time, numbers and other formatting.

**CAUTION!**

When changing the 'Regional Settings', please note that only *English* and *German* are supported, other languages can lead to a system crash.



Please note that changes made are set back after PowerOFF-PowerON and are only stored via 'Start → Programs → KuK\_Tools → KuK Tools' [Store].

**Set MPI parameters**

The dialog window where to configure the integrated MPI interface can be found under 'Start → Settings → Control Panel → MPI Configuration'.

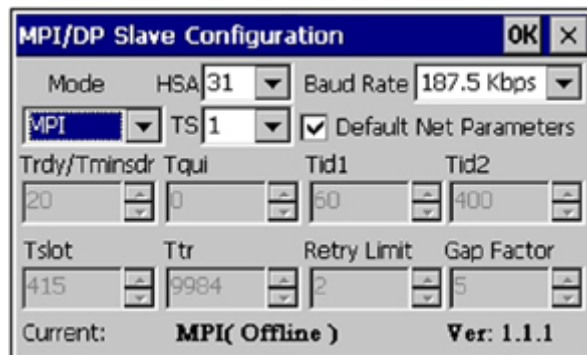

- **HSA**  
Here you set the highest MPI address (highest station address). Within a MPI network the highest MPI address must be identical!
- **TS**  
With TS (this station) you set the local MPI address for the Touch Panel.
- **Baud Rate**  
Enter here the transfer velocity of your MPI net. The baud rate has to be identical for every MPI participant within the network. According to the Baud Rate the network parameters are set.
- **Default Net Parameters**  
It is recommended not to alter the Default Net Parameters that are set by the baud rate.
- **Status**  
The status of the MPI interface is monitored via Status as "Offline", "Online" or "Error".



Here made changes are also not saved after PowerOFF-PowerON. Save the data permanently in the current registry file via [Store] under 'Start → Programs → KuK\_Tools → KuK Tools'.

### 3.5 Access to the network resources

#### Overview

The Touch Panel allows you to access shared resources in a Microsoft network like drives and printer. Here you may assign existing public directories or printer in the network to local directories or printer in the Touch Panel.

Condition for this is that you are logged in to the network with your user name and password. The assignment of a network resource is performed in the Touch Panel via the command console "Command Prompt". Start the command console with 'START → Programs → Command Prompt'.

The access to the network resource is performed with the commands *Net view* and *Net use*.

#### List released resources

Shared resources of a network PC can be listed by the command: `\> net view PC-Name`

For example `net view testserver` lists all shared resources of the network PC "test server". To test the physical connection a PING to the IP address of the network PC can be executed if there are problems while contacting the network PC.

```
\> net view testserver
Shared resources on \\testserver:

Share name      Type      Used as      Comment
-----
Archiv          Disc      (null)       Process data
KyoEDV          Print     (null)       Kyocera FS-680 Printer
Command completed successfully
\>
```

#### Connect net drive

The connection of a local name at the Touch Panel with a shared drive of the network PC happens with the following approach:

1. Enter the following in the command prompt: `\> net use local_name \network drive /user:User name`
2. Enter *user name*, *password* and where app. *user group*.

After successful login the following message appears: 'Successfully mapped to network name'.

The connected network drive is then available on the Touch Panel with the *local\_name* via *My Device* under *Network*.

#### Example:

Local\_Name: data, network drive: testserver\archive, Username:guest

Input: `\> net use data \\testserver\archiv /user:guest`

The connected network drive is then available via `\network\data` at the Touch Panel.

**Configure network printer**

The configuration of a network printer happens with the following approach:

1. Enter this command into the command prompt: `\> net use printer name network printer`

Example:

Printer name: Printer, network printer: `\\testserver\printer`

Entry: `\> net use printer \\testserver\printer`

2. Enter *user name*, *password* and if necessary *user group*.

After the successful login the following message appears

```
Successfully mapped to network printer
```

The printer can now be accessed as "network\printer".

**Test print**

For example you can print the content of the current directory using `\> dir > network \printer`.

**List network connections**

The listing command for all network connections of your Touch Panel is `\> net use`

```
\> net use
Connected resources:

Status          Local Name          Remote Name
-----
Connected       data                \\testserver\archiv
Connected       printer             \\testserver\printer
Command completed successfully
\>
```

**Terminate network connections**

You can terminate already assigned network resources via

```
\> net use local_name /d
```

Example: `\> net use data /d` deletes the network connection to the drive "archive" of "test server".



*To save the settings also after power on, you have to store them to the registry with 'START → Programs → KuK\_Tools → KuK Tools' [Store].*

## 4 Industrial Security and Installation guidelines

### 4.1 Industrial security in information technology

#### Latest version

This chapter can also be found as a guide '*Industrial IT Security*' at [www.yaskawa.eu.com](http://www.yaskawa.eu.com)

#### Hazards

The topic of data security and access protection has become increasingly important in the industrial environment. The increased networking of entire industrial systems to the network levels within the company together with the functions of remote maintenance have all served to increase vulnerability. Hazards can arise from:

- Internal manipulation such as technical errors, operating and program errors and deliberate program or data manipulation.
- External manipulation such as software viruses, worms and Trojans.
- Human carelessness such as password phishing.

#### Precautions

The most important precautions to prevent manipulation and loss of data security in the industrial environment are:

- Encrypting the data traffic by means of certificates.
- Filtering and inspection of the traffic by means of VPN - "Virtual Private Networks".
- Identification of the user by "Authentication" via safe channels.
- Segmenting in protected automation cells, so that only devices in the same group can exchange data.
- Deactivation of unnecessary hardware and software.

#### Further Information

You can find more information about the measures on the following websites:

- Federal Office for Information Technology [www.bsi.bund.de](http://www.bsi.bund.de)
- Cybersecurity & Infrastructure Security Agency [us-cert.cisa.gov](http://us-cert.cisa.gov)
- VDI / VDE Society for Measurement and Automation Technology [www.vdi.de](http://www.vdi.de)



### 4.1.1 Protection of hardware and applications

#### Precautions

- Do not integrate any components or systems into public networks.
  - Use VPN "Virtual Private Networks" for use in public networks. This allows you to control and filter the data traffic accordingly.
- Always keep your system up-to-date.
  - Always use the latest firmware version for all devices.
  - Update your user software regularly.
- Protect your systems with a firewall.
  - The firewall protects your infrastructure internally and externally.
  - This allows you to segment your network and isolate entire areas.
- Secure access to your plants via user accounts.
  - If possible, use a central user management system.
  - Create a user account for each user for whom authorization is essential.
  - Always keep user accounts up-to-date and deactivate unused user accounts.
- Secure access to your plants via secure passwords.
  - Change the password of a standard login after the first start.
  - Use strong passwords consisting of upper/lower case, numbers and special characters. The use of a password generator or manager is recommended.
  - Change the passwords according to the rules and guidelines that apply to your application.
- Deactivate inactive communication ports respectively protocols.
  - Only the communication ports that are used for communication should be activated.
  - Only the communication protocols that are used for communication should be activated.
- Consider possible defence strategies when planning and securing the system.
  - The isolation of components alone is not sufficient for comprehensive protection. An overall concept is to be drawn up here, which also provides defensive measures in the event of a cyber attack.
  - Periodically carry out threat assessments. Among others, a comparison is made here between the protective measures taken and those required.
- Limit the use of external storage media.
  - Via external storage media such as USB memory sticks or SD memory cards, malware can get directly into a system while bypassing a firewall.
  - External storage media or their slots must be protected against unauthorized physical access, e.g. by using a lockable control cabinet.
  - Make sure that only authorized persons have access.
  - When disposing of storage media, make sure that they are safely destroyed.
- Use secure access paths such as HTTPS or VPN for remote access to your plant.
- Enable security-related event logging in accordance with the applicable security policy and legal requirements for data protection.

## 4.1.2 Protection of PC-based software

### Precautions

Since PC-based software is used for programming, configuration and monitoring, it can also be used to manipulate entire systems or individual components. Particular caution is required here!

- Use user accounts on your PC systems.
  - If possible, use a central user management system.
  - Create a user account for each user for whom authorization is essential.
  - Always keep user accounts up-to-date and deactivate unused user accounts.
- Protect your PC systems with secure passwords.
  - Change the password of a standard login after the first start.
  - Use strong passwords consisting of upper/lower case, numbers and special characters. The use of a password generator or manager is recommended.
  - Change the passwords according to the rules and guidelines that apply to your application.
- Enable security-related event logging in accordance with the applicable security policy and legal requirements for data protection.
- Protect your PC systems by security software.
  - Install virus scanners on your PC systems to identify viruses, trojans and other malware.
  - Install software that can detect phishing attacks and actively prevent them.
- Always keep your software up-to-date.
  - Update your operating system regularly.
  - Update your software regularly.
- Make regular backups and store the media at a safe place.
- Regularly restart your PC systems. Only boot from storage media that are protected against manipulation.
- Use encryption systems on your storage media.
- Perform security assessments regularly to reduce the risk of manipulation.
- Use only data and software from approved sources.
- Uninstall software which is not used.
- Disable unused services.
- Activate a password-protected screen lock on your PC systems.
- Always lock your PC systems as soon as you leave your PC workstation.
- Do not click any links that come from unknown sources. If necessary ask, e.g. on e-mails.
- Use secure access paths such as HTTPS or VPN for remote access to your PC system.

## 4.2 Installation guidelines

### 4.2.1 Basic rules for the EMC-equitable assembly of installations

#### General

The installation guidelines contain information about the interference free deployment of a PLC system. There is the description of the ways, interference may occur in your PLC, how you can make sure the electromagnetic compatibility (EMC), and how you manage the isolation.

#### What does EMC mean?

Electromagnetic compatibility (EMC) means the ability of an electrical device, to function error free in an electromagnetic environment without being interfered respectively without interfering the environment.

The components are developed for the deployment in industrial environments and meets high demands on the EMC. Nevertheless you should project an EMC planning before installing the components and take conceivable interference causes into account.

**Possible interference causes**

Electromagnetic interferences may interfere your control via different ways:

- Electromagnetic fields (RF coupling)
- Magnetic fields with power frequency
- Bus system
- Power supply
- Protected earth conductor

Depending on the spreading medium (lead bound or lead free) and the distance to the interference cause, interferences to your control occur by means of different coupling mechanisms.

There are:

- galvanic coupling
- capacitive coupling
- inductive coupling
- radiant coupling

**Coupling mechanisms and interference sources**

The following table shows the four different coupling mechanisms, their causes and possible interference sources.

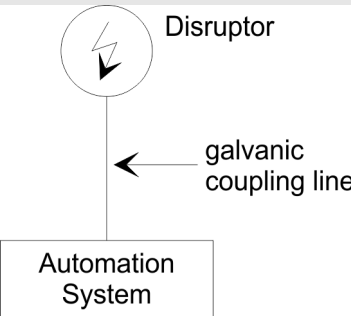
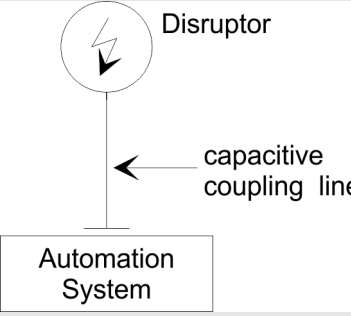
Coupling mechanism	Cause	Typical source
<p><b>Galvanic coupling</b></p> 	Galvanic or metallic coupling always occurs, when two current circuits have a common line.	<ul style="list-style-type: none"> <li>■ Pulsed devices (Net influence from transducers and foreign net devices)</li> <li>■ Starting motors</li> <li>■ Different potential of component cubicles with common current supply</li> <li>■ Static discharges</li> </ul>
<p><b>Capacitate coupling</b></p> 	Capacitate or electric coupling occurs between conductors with different potential. The coupling is proportionate to the temporal change of the voltage.	<ul style="list-style-type: none"> <li>■ Interference through parallel signal lines</li> <li>■ Static discharge of the personnel</li> <li>■ Contactors</li> </ul>

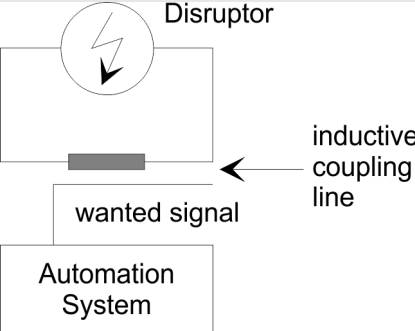
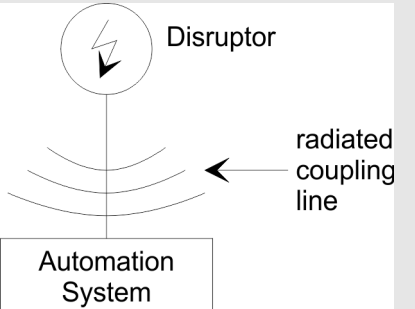
Coupling mechanism	Cause	Typical source
<p><b>Inductive coupling</b></p> 	<p>Inductive or magnetic coupling occurs between two current active line loops. The magnetic flows associated with the currents induct interference voltages. The coupling is proportional to the time related change of the current.</p>	<ul style="list-style-type: none"> <li>■ Transducers, motors, electric welding devices</li> <li>■ Parallel net cables</li> <li>■ Cables with toggled currents</li> <li>■ Signal cable with high frequency</li> <li>■ Unused coils</li> </ul>
<p><b>Radiate power coupling</b></p> 	<p>One talks of radiate power coupling, when an electromagnetic wave meets a line circuit. The hit of the wave inducts currents and voltages.</p>	<ul style="list-style-type: none"> <li>■ Sender in the neighbourhood (e.g. walkie-talkie)</li> <li>■ Sparking lines (sparking plugs, collector of electric motors, welding devices)</li> </ul>

**Basic rules for EMC**

In the most times it is enough to take care of some elementary rules to guarantee the EMC. Please regard the following basic rules when installing your PLC.

- Take care of a correct area-wide grounding of the inactive metal parts when installing your components.
  - Install a central connection between the ground and the protected earth conductor system.
  - Connect all inactive metal extensive and impedance-low.
  - Please try not to use aluminium parts. Aluminium is easily oxidizing and is therefore less suitable for grounding.
- When cabling, take care of the correct line routing.
  - Organize your cabling in line groups (high voltage, current supply, signal and data lines).
  - Always lay your high voltage lines and signal respectively data lines in separate channels or bundles.
  - Route the signal and data lines as near as possible beside ground areas (e.g. suspension bars, metal rails, tin cabinet).
- Proof the correct fixing of the lead isolation.
  - Data lines must be shielded.
  - Analog lines must be shielded. When transmitting signals with small amplitudes the one sided laying of the isolation may be favourable.
  - Cables for frequency inverters, servo and stepper motors must be shielded.
  - Lay the line isolation extensively on an isolation/protected earth conductor rail directly after the cabinet entry and fix the isolation with cable clamps.
  - Make sure that the isolation/protected earth conductor rail is connected impedance-low with the cabinet.
  - Use metallic or metallised plug cases for isolated data lines.

- In special use cases you should appoint special EMC actions.
  - Consider to wire all inductivities with erase links.
  - Please consider luminescent lamps can influence signal lines.
- Create a homogeneous reference potential and ground all electrical operating supplies when possible.
  - Please take care for the targeted employment of the grounding actions. The grounding of the PLC serves for protection and functionality activity.
  - Connect installation parts and cabinets with your PLC in star topology with the isolation/protected earth conductor system. So you avoid ground loops.
  - If there are potential differences between installation parts and cabinets, lay sufficiently dimensioned potential compensation lines.

## 4.2.2 EMC-equitable assembly

Mostly, measures for suppressing interference voltages are only taken, when the control is already in commission and the perfect receive of a wanted signal is disturbed. Causes for such interference's are in the most cases inadequate reference potentials, coming from mistakes at the device assembly and installation.

### Guidelines for assembling and grounding of inactive metal parts

When assembling the devices, you have to ensure the large-surface grounding of the inactive metal parts. A correctly done grounding supports an unambiguous reference potential for the control and reduces the impact of coupled interferences.

Grounding means the conducting connection of all inactive metal parts. The sum of all interconnected inactive parts is called ground.

Inactive parts are all conductive parts electrically separated from all active parts by means of a basic isolation and that may only get voltage in case of an error.

The ground must not adopt dangerous contact voltage even in case of an error. Thus you have to connect the ground with the protected earth conductor. To avoid ground loops, local distant ground constructions (cubicles, construction and machine parts) have to be connected with the protected earth conductor system in star-topology.

Please regard at grounding:

- Connect the inactive metal parts as carefully as the active ones.
- Take care of impedance-low metal-metal-connections, e.g. with large-surface and well conductive contacts.
- If you include coated or anodized metal parts in the grounding, you have to come through the isolating protection layers. For this you may use special contact washers or remove the isolation layer.
- Protect the connection points from corrosion, e.g. with grease.
- Moveable grounding parts (e.g. cubicle doors) have to be connected via flexible ground strips. The ground strips should be short and have a large surface, because the surface is decisive for the diversion of high frequency interferences.

### 4.2.3 EMC-equitable cabling

#### Line routing

Content of this section is the line routing of bus, signal and supply lines. Object of the line routing is to suppress the "slurring" at parallel lines.

#### Line routing inside and outside of cubicles

For an EMC-equitable routing of the lines it is convenient to divide the cables in different groups and install each group itself:

##### Group A

- screened bus and data lines
- screened analog lines
- unshielded lines for direct voltage  $\leq 60V$
- unshielded lines for alternating voltage  $\leq 25V$
- Coaxial cables for monitors

##### Group B

- unshielded lines for direct voltage  $>60V$  and  $\leq 400V$
- unshielded lines for alternating voltage  $>25V$  and  $\leq 400V$

##### Group C

- unshielded lines for direct and alternating voltage  $>400V$

##### Group D

- Lines for H1 respectively TCP/IP

#### Combination of groups

Following the table you may see the conditions for the cabling of the line groups by combining the single groups:

	Group A	Group B	Group C	Group D
Group A	[1]	[2]	[3]	[4]
Group B	[2]	[1]	[3]	[4]
Group C	[3]	[3]	[1]	[4]
Group D	[4]	[4]	[4]	[1]

[1]	The lines may be installed in common bundles or cable trusses.
[2]	The lines have to be installed in different bundles or cable trusses (without min. distance).
[3]	The lines have to be installed in different bundles or cable trusses inside of cubicles and outside of the cubicle but inside the building in separated cable trusses with a min. distance of 10cm.
[4]	The lines have to be installed in different bundles or cable trusses with a min. distance of 50cm.

#### Line routing outside of buildings

Wherever possible, exterior cabling should be installed on metallic cable trays. A galvanic connection must be provided for joints between cable trays. You must abide by the applicable lightning protection and grounding regulations when installing exterior cables.

## Lightning protection



### CAUTION!

Where cables and signal lines for PLC equipment are installed outside of buildings, the conditions for internal and external lightning protection must be satisfied.

- Exterior lines should either be installed in metallic conduit pipes that is grounded on both ends or in steel-reinforced concrete cable trunks with continuously connected reinforcing.
- Signal lines should be protected against overvoltage by varistors or by lightning arrester filled with rare gas.
- Install these protective elements at the location where the cables enter the building.



*Any lightning protection system must be based on an individual assessment of the entire plant. For questions please contact Yaskawa.*

## Equipotential bonding

Potential differences can occur between different sections when controllers and peripheral equipment are connected by means of non-isolated connections or the screens of screened cables are connected at both ends and grounded on different sections of the plant. One reason for a potential difference can be that different sections of the plant are powered from different power sources. These potential differences must be reduced by means of equipotential bonding conductors to ensure that the electronic equipment employed on the plant operates properly.

## Rules for equipotential bonding

- The lower the impedance of the equipotential bonding conductor, the higher the effectiveness of potential equalization.
- The impedance of the equipotential bonding conductor must not exceed 10% of the impedance of the screen where screened signal lines are connected between the different sections of the plant and the screening is connected to ground/neutral on both sides.
- The cross-sectional area of the equipotential bonding conductor must be calculated to carry the maximum equalization current. The following cross-sections have been successfully employed:
  - 16mm<sup>2</sup> Cu for equipotential bonding conductors up to 200m
  - 25mm<sup>2</sup> Cu equipotential bonding conductors exceeding 200m.
- Use copper or galvanized steel for equipotential bonding conductors. These must be connected to ground/neutral by means of large-surface connections that are protected from corrosion.
- The equipotential bonding conductor should be installed in such a manner that it includes the smallest surface between the bonding conductor and the signal lines.

## Screening of lines and cables

Screening is one method commonly used to reduce (attenuate) the interference pick-up from magnetic, electrical or electromagnetic fields.

- Interference on screens is conducted to ground by the conductive connection between the screen and the screening rain/enclosure. To avoid interference from these currents it is very important that the neutral connection is a low-impedance connection.
- You should only use cables that are provided with a braided screen. The degree of screening should be more than 80%.



- Avoid cables with foil-type screens as the foil can be easily damaged by tension and pressure at the point of attachment; this can result in reduced effectiveness of the screening action.
- As a rule you should always ground the screens of cables on both ends. This is the only way in which you can ensure that high frequency interference is attenuated properly.

### One-sided grounding of screens

In exceptional cases it may be necessary to ground the screen on one side only. However, this will only attenuate the lowest frequencies. The one-sided grounding of screens may provide advantages when:

- It is not possible to install an equipotential bonding conductor
- Analogue signals (a few mV or mA) must be transmitted
- Foil-type screening (static screening) is employed.

You should always use metallic or metallised covers for serial data lines. Connect the screen of the data line to the cover. Do **not** connect the screen to PIN 1 of the connector! In case of stationary operations it is recommended that the remove the insulation from the screened cable without cutting the screen and to attach this point to the screening/neutral rail.



*Potential differences can give rise to an equalization current via the screen connected between the two ground connections. In this case you must install an additional equipotential bonding conductor.*

### Connecting the screen

Please observe the following points when you handle the screens:

- Use only metallic cable clamps when connecting the screening of cables. These clamps must provide a good electrical contact and a large-surface connection to the screen.
- Attach the screens to the screening rail directly at the point where the cables enter the enclosure. The screening conductor must be continued to the module without interruption, however, it must not be connected to the module!

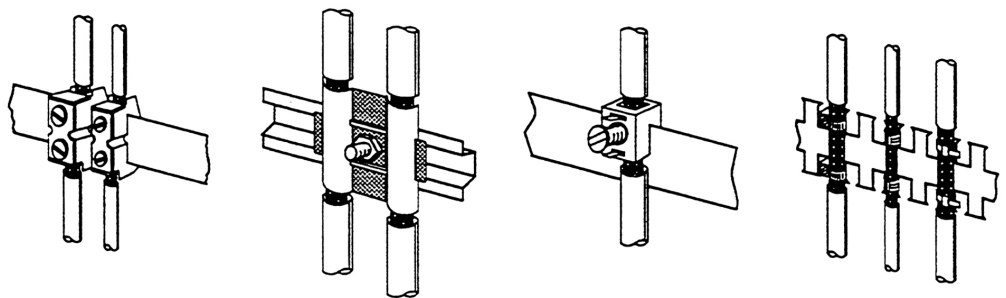

### 4.2.4 Special precautions providing high noise immunity

#### Inductors require snubber networks

Inductors controlled by your programmable controller (e.g. contactors and relays) do not normally require additional snubber networks or suppressors as the respective modules have been provided with the required components.

#### Equipotential bonding

Snubber networks must only be connected to inductors when output circuits can be disabled by means of additional contacts (e.g. relay contacts). In this case the integrated suppressors on the module are also disabled. You can connect diodes to suppress back-emf, varistors or RC-networks to the inductors.

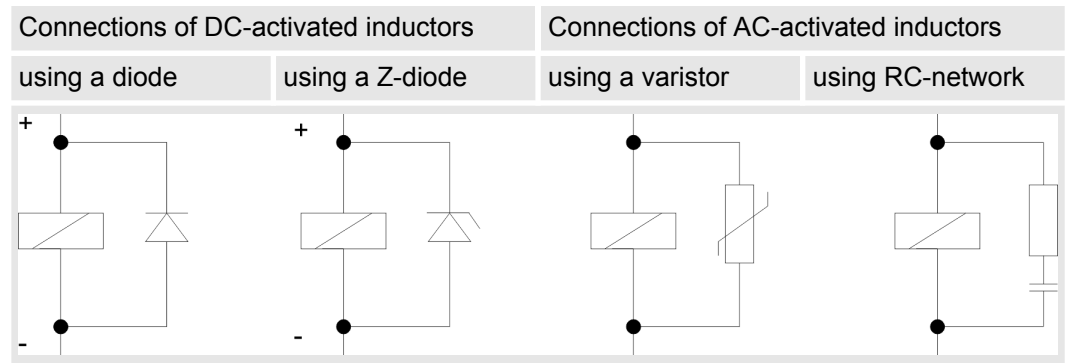

#### Power outlet for PGs

Every cubicle must be provided with a power outlet for the PU. These outlets must be wired to the distribution system, which is also used to connect the neutral conductor for the cubicle.

#### Cubicle illumination

The cubicle illumination should consist of incandescent lights, e.g. LINESTRA-lamps. Avoid using fluorescent lamps as these lamps can cause interference. If you can not avoid using fluorescent lamps you should implement the steps outlined in the following figure.

#### Suppression of fluorescent lamps in cubicles

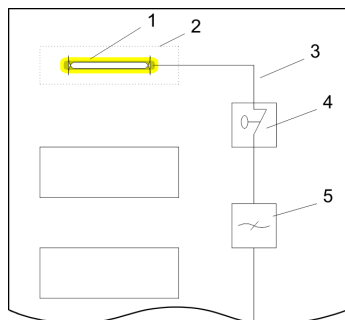

- 1 Fluorescent lamp
- 2 Screen above the lamp
- 3 Screened cable
- 4 Switch with metallic cover
- 5 Line filter or screened power cable

#### 4.2.5 Checklist for the EMC-compliant installation of controllers

EMC-measures	Space for Notes
<b>Connection of the inactive parts</b>	
You should take special care to check the connections of:	
<ul style="list-style-type: none"> <li>■ Module racks</li> <li>■ Frames</li> <li>■ Screen and protected earth conductor</li> </ul>	
Are all the inactive metal parts interconnected by means of large-surface and low-impedance connections?	
Has a proper connection been installed with respect to the ground/protected earth conductor system?	
Has the isolation been removed from varnished and anodized surfaces or have these connections been fitted with special contact washer?	
Have the connection been protected from corrosion, e.g. by means of grease?	
Have doors been grounded by means of grounding straps connected to the body of the cubicle?	
<b>Cable routing</b>	
Cabling divided into groups?	
Power cables (230 ... 400V) and signal lines installed in separate channels or bunches?	
<b>Potential compensating</b>	
When installing the equipment at separate locations, check the installation of the potential compensating line.	
<b>Cable screen</b>	
All covers of plugs are metallic?	
All analog and data lines installed screened?	
Line screens attached to the screening or the protected earth conductor?	
Have the screens been connected by means of large-surface and low-impedance cable clamps?	
Cable screens grounded both-sided where possible?	
<b>Inductors</b>	
Have the coils of contactors controlled by means of contacts been connected to snubber networks?	

## Appendix

## A History of changes

Rev.	Changes
22-04	The manual was created.
22-10	Chapter "Hardware description" <ul style="list-style-type: none"><li>■ Description "Use in difficult operating conditions" was added.</li></ul> Chapter "Deployment" <ul style="list-style-type: none"><li>■ The '<i>Explorer</i>' selection was added under '<i>Autostart</i>' in the Startup Manager.</li></ul>
23-10	Chapter "Deployment" <ul style="list-style-type: none"><li>■ Caution notice has been added under "Commissioning" and "Windows Embedded Compact 7 operating system".</li></ul>