

SPOT LED



THE ULTRA POWERFUL LED LUMINAIRE.



Probably the easiest and most convenient way to install light in small machine tools is called SPOT LED. Its strong, but energy-saving LEDs provide spot or area lighting depending on the variant you choose: The fact that the luminaire can be easily and quickly attached to the machine wall thanks to the magnet that comes as an accessory means that you can rapidly generate light where you need it – thanks to its compact design, even close to the tool.

- Very bright with low energy consumption
- Variants with narrow and wide angles of illumination
- Easy, fast and flexible installation
- Absolutely even and flicker-free light for added safety
- Without heat development in the beam direction
- Adjustable beam direction
- Unlimited functionality irrespective of fluctuations of mains voltage
- High system of protection
- Maintenance-free: LED life of up to 50,000 hours and more





efficientLight

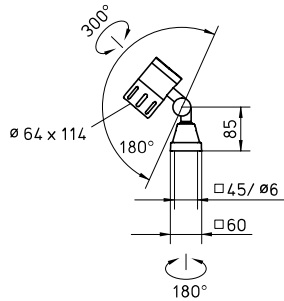

Features at a glance

- 3 x HIGH POWER LED
- Color temperature daylight white 5,700 K
- 10° or 40° angle of illumination
- Black anodized aluminum housing, 3 mm thick safety glass
- Head joint for individual adjustments
- Without switch
- System of protection IP67; class of protection III
- Supplied with 3 m mains lead and free stranded wires
- Various fastenings and operating devices for connecting to the mains voltage as accessories

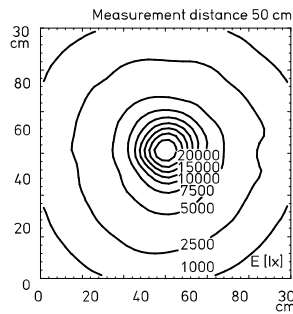

Illuminance with 10° lens

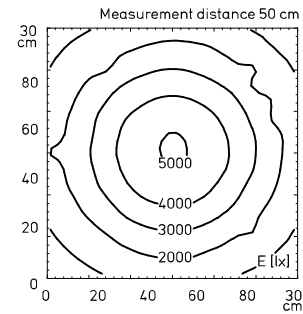

Illuminance with 40° lens

Integrated machine luminaires



Surface-mounted luminaires



Tube luminaires



Arm-mounted luminaires

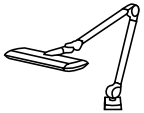

Flexible-tube luminaires



Pivoting-head luminaires

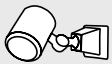

CONSUMPTION	OPERATING DEVICE	CONNECTED LOAD	SPECIAL FEATURE	E_m / E_{max}^*	MODEL	ORDER NO.
6 W	-	16 – 30 VAC / 16 – 40 VDC	10° lens	3358 / 22350 lx ¹	MCXFL 3 S	112 459 004 - 000 829 50
6 W	-	16 – 30 VAC / 16 – 40 VDC	40° lens	2539 / 5095 lx ¹	MCXFL 3 S	112 459 006 - 000 878 99

* E_m = medium illuminance; E_{max} = maximum illuminance; ¹ Measuring range 30 cm x 30 cm / Measuring distance 50 cm
 Also available as an arm-mounted luminaire, flexible-tube luminaire, integrated machine luminaire and surface-mounted luminaire

SPOT LED



HARD CORE, FLEXIBLE ADJUSTMENT.



A luminaire that is used close to the workplace should be both compact, powerful and robust. This is why the SPOT LED combines 3 LEDs in its extremely small, insensitive housing. They produce flicker-free light that can be precisely positioned even in small spaces thanks to the flexible tube.

- Very bright and energy-efficient
- Variants with narrow and wide angles of illumination
- Wide range
- Comfort and safety thanks to absolutely even and flicker-free light
- Without heat development in the beam direction
- Convenient switching on and off from your working position
- Maintenance-free: LED life of up to 50,000 hours and more

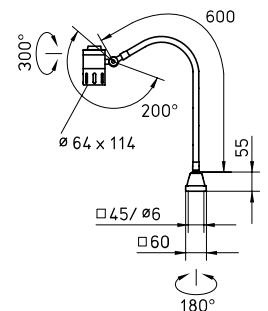

Features at a glance

- 3 x HIGH POWER LED
- Color temperature daylight white 5,700 K
- 10° or 40° angle of illumination
- Black aluminum anodized housing, 3 mm thick safety glass
- Metal flexible tube for at least 20,000 movements
- With switch in the luminaire head
- System of protection IP65 (without mains plug) or IP40 (with mains plug, luminaire head IP65); class of protection III (without mains plug) or II (with mains plug)
- Supplied with 3 m mains lead with free stranded wires or with mains plug type CEE 7/16 (Euro plug), BS 1363 and NEMA 1-15P
- Various fastenings as accessories

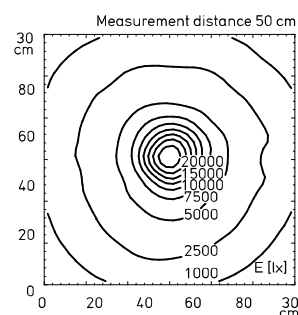

Illuminance with 10° lens

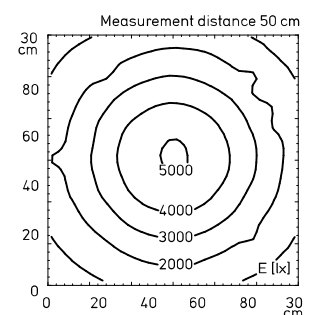

Illuminance with 40° lens



Integrated machine luminaires



Surface-mounted luminaires



Tube luminaires



Arm-mounted luminaires

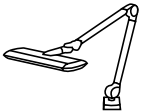

Flexible-tube luminaires

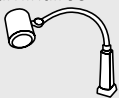

CONSUMPTION	OPERATING DEVICE	CONNECTED LOAD	SPECIAL FEATURE	E_m/E_{max}^*	MODEL	ORDER NO.
7 W	Mains plug	100 – 240 V, 50/60 Hz	10° lens	3358/22350 lx ¹	MCTFL 3 N	112 462 007 - 000 919 26
7 W	Mains plug	100 – 240 V, 50/60 Hz	40° lens	2539/5095 lx ¹	MCTFL 3 N	112 462 009 - 000 919 70
6 W	–	16 – 30 VAC/16 – 40 VDC	10° lens	3358/22350 lx ¹	MCTFL 3 S	112 462 001 - 000 918 51
6 W	–	16 – 30 VAC/16 – 40 VDC	40° lens	2539/5095 lx ¹	MCTFL 3 S	112 462 003 - 000 919 60

* E_m = medium illuminance; E_{max} = maximum illuminance; ¹ Measuring range 30 cm x 30 cm/Measuring distance 50 cm

Also available as an arm-mounted luminaire, pivoting-head luminaire, integrated machine luminaire and surface-mounted luminaire

SPOT LED



HIGHLY CONCENTRATED LIGHT.



LED

The SPOT LED has three combined LEDs and thus an extremely high luminous intensity as spot or area lighting. But that's not the only flexibility it boasts: In combination with the arm that stretches out into the room, it is no problem lighting every square-millimeter of even the largest working areas.

- Variants with narrow and wide angles of illumination
- Big working radius – ideal for large work spaces, machines or systems
- Comfort and safety thanks to absolutely even and flicker-free light
- Low energy consumption
- Without heat development in the beam direction
- No danger of accidents due to stroboscopic effect
- Maintenance-free: LED life of up to 50,000 hours and more
- Convenient switching on and off from your working position

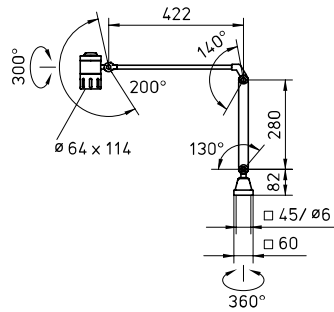

Integrated machine luminaires



Surface-mounted luminaires



Tube luminaires



Arm-mounted luminaires

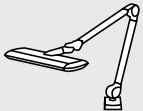

Features at a glance

- 3 x HIGH POWER LED
- Color temperature daylight white 5,700 K
- 10° or 40° angle of illumination
- Black aluminum anodized housing, 3 mm thick safety glass
- Arm relieved by friction
- With switch in the luminaire head
- System of protection IP65 (without mains plug) or IP40 (with mains plug, luminaire head IP65); class of protection III (without mains plug) or II (with mains plug)
- Supplied with 3 m mains lead with free stranded wires or with mains plug type CEE 7/16 (Euro plug), BS 1363 and NEMA 1-15P
- Various fastenings as accessories

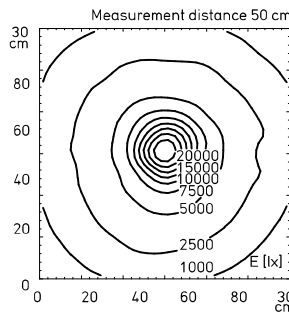

Illuminance with 10° lens

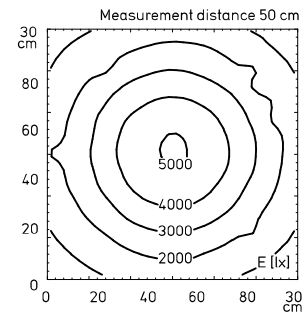

Illuminance with 40° lens

CONSUMPTION	OPERATING DEVICE	CONNECTED LOAD	SPECIAL FEATURE	E_m/E_{max} *	MODEL	ORDER NO.
7 W	Mains plug	100 – 240 V, 50/60 Hz	10° lens	3358/22350 lx ¹	MCBFL 3 N	112 463 007 - 000 916 62
7 W	Mains plug	100 – 240 V, 50/60 Hz	40° lens	2539/5095 lx ¹	MCBFL 3 N	112 463 009 - 000 919 54
6 W	–	16 – 30 VAC/16 – 40 VDC	10° lens	3358/22350 lx ¹	MCBFL 3 S	112 463 001 - 000 916 60
6 W	–	16 – 30 VAC/16 – 40 VDC	40° lens	2539/5095 lx ¹	MCBFL 3 S	112 463 003 - 000 919 35

* E_m = medium illuminance; E_{max} = maximum illuminance; ¹ Measuring range 30 cm x 30 cm/Measuring distance 50 cm

Also available as a flexible-tube luminaire, pivoting-head luminaire, integrated machine luminaire and surface-mounted luminaire

SPOT LED



CONCENTRATED LIGHT WITH LOW SPACE REQUIREMENTS.



The SPOT LED for permanent integration in the machine combines 3 LEDs in such compact housing that you could hardly imagine a smaller luminaire.

- Permanently high lighting quality
- Particularly space-saving integration
- No surface that is subject to the accumulation of chips
- Variants with narrow and wide angles of illumination
- Direct connection to 24 V without additional components
- Resistance-tested with many cooling agents and lubricants
- High system of protection
- Maintenance-free: LED life of up to 50,000 hours and more
- Unlimited functionality irrespective of frequent switching or fluctuations of mains voltage



Integrated machine luminaires



efficient light

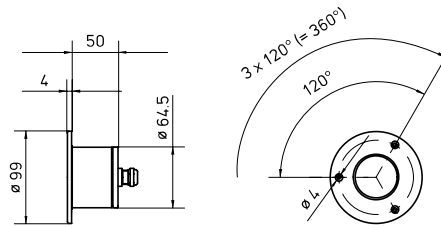

Features at a glance

- 3 x HIGH POWER LED
- Color temperature daylight white 5,700 K
- 10° or 40° angle of illumination
- Black aluminum anodized housing, 3 mm thick safety glass
- Integration in recess with screws
- Without switch
- System of protection IP67; class of protection III
- Supplied with 3 m mains lead and free stranded wires
- Ballast to connect to the mains voltage as an accessory

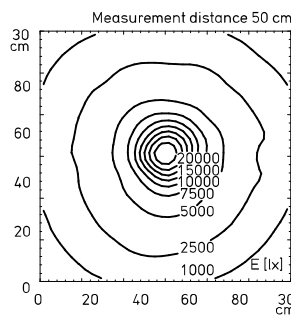

Illuminance with 10° lens

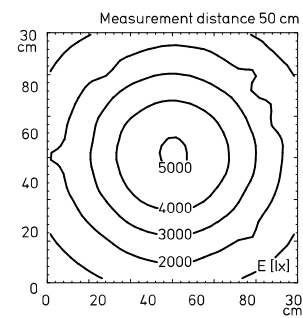

Illuminance with 40° lens

16 – 30 VAC / 16 – 40 VDC

CONSUMPTION	OPERATING DEVICE	DIMENSIONS	SPECIAL FEATURE	E_m/E_{max}^*	MODEL	ORDER NUMBER
6 W	–	ø 99 mm	10° lens	3358/22350 lx ¹	MCEYL 3 S	112 460 001 - 000 829 95
6 W	–	ø 99 mm	40° lens	2539/5095 lx ¹	MCEYL 3 S	112 460 003 - 000 878 91

* E_m = Medium illuminance; E_{max} = Maximum illuminance; ¹ Measuring range 30 cm x 30 cm / Measuring distance 50 cm

Also available as an arm-mounted luminaire, flexible tube luminaire, pivoting-head luminaire and surface-mounted luminaire