

**ebm-papst St. Georgen GmbH & Co. KG**

Hermann-Papst-Str. 1
 D-78112 St. Georgen
 Phone +49 (0) 7724 81-0
 Fax +49 (0) 7724 81-1309
 info2@de.ebmpapst.com
 www.ebmpapst.com

Nominal data

Type	412	
Nominal voltage	VDC	12
Nominal voltage range	VDC	10 .. 14
Speed (rpm)	min ⁻¹	6000
Power consumption	W	0.8
Min. ambient temperature	°C	-20
Max. ambient temperature	°C	70
Air flow	m ³ /h	10
Sound power level	B	3.8
Sound pressure level	dB(A)	18

ml = Max. load · me = Max. efficiency · fa = Free air · cs = Customer specification · ce = Customer equipment
 Subject to change



Technical description

Weight	0.027 kg
Dimensions	40 x 40 x 20 mm
Impeller material	Glass-fiber reinforced PA plastic
Housing material	Glass-fiber reinforced PBT plastic
Airflow direction	Exhaust over struts
Direction of rotation	Counterclockwise, viewed toward rotor
Storage	Sintec sleeve bearing
Service life L10 at 20 °C	50000 h
Service life L10 at 60 °C	20000 h
Cable	Leads AWG 28, TR 64, stripped and tin-plated.
Motor protection	Protection against reverse polarity and blocked rotor.
Approval	VDE, CSA, UL
Option	Possible custom designs: Speed signal Go / No-go alarm PWM control input Moisture protection

Product drawing

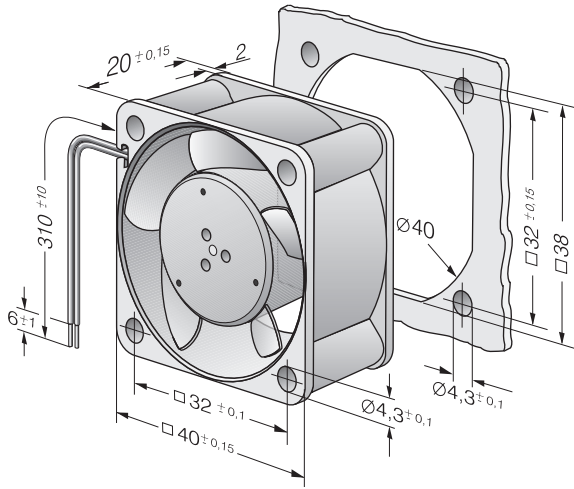

Curves: Air performance

