

DataVS2 - VSM Vision Sensor Monitor

QUICK REFERENCE GUIDE

DESCRIPTION

The VSM is an external monitor compatible with all the vision sensors of the DataVS2 series. The device displays images, results and statistics of the check carried-out on the sensor as well as the fine tuning of the configuration parameters.

- Monitor with 3.5" colour LCD display;
- Operator interface with 8 push-buttons and 8 signalling LEDs;
- Compatibility with the entire DataVS2 series;
- Image and statistics visualisation;
- Configuration parameter modification;
- Memorisation of 20 different inspections;
- Different user profiles management through passwords.

FEATURES

VSM MONITOR

The VSM displays the images processed by the DataVS2, manages inspections and carries-out the parameter fine tuning.

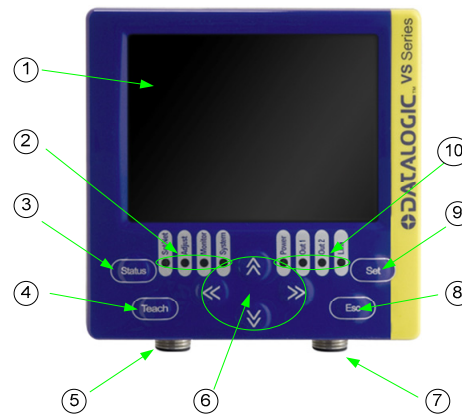

1. Monitor
2. Status LEDs
3. STATUS Button
4. TEACH Button
5. Power Supply Connector
6. ARROW Buttons
7. Ethernet Network Connector
8. ESC Button
9. SET Button
10. Power, OUT, ETH Link LEDs

SIGNALLING LEDS

From left to right

1. Setup Mode, green;
2. Adjust Mode, green;
3. Monitor Mode, green;
4. Main Menu, green;
5. Power Supply, green;
6. Digital Output 1, yellow;
7. Digital Output 2, yellow;
8. Connection Status, green.



ELECTRICAL CONNECTIONS

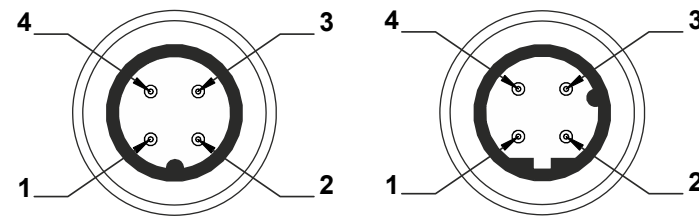

M12 4-Pin Male
(Power Supply)

- pin 1: +24 Vdc
- pin 2: Reserved
- pin 3: GROUND
- pin 4: Reserved

M12 Reverse Keyed 4-Pin Male
(Ethernet Network)

- pin 1: Ethernet RX+
- pin 2: Ethernet TX+
- pin 3: Ethernet RX-
- pin 4: Ethernet TX-

The VSM monitor can be connected in a LAN network using a straight Ethernet cable or can be connected using a point to point connection directly to a vision sensor.

LAN CONNECTION

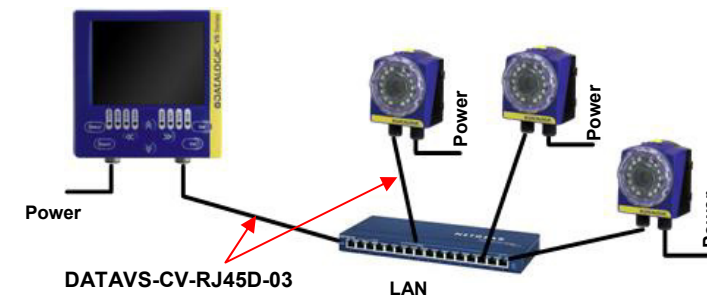

POINT-TO-POINT CONNECTION

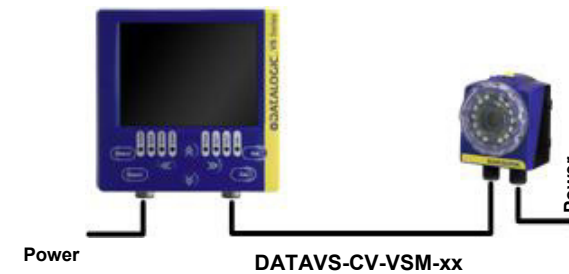

GROUND CONNECTION

To comply with the EMC requirements, the Ethernet cable shield has to be grounded. (Use the yellow/green cable supplied with the VSM).

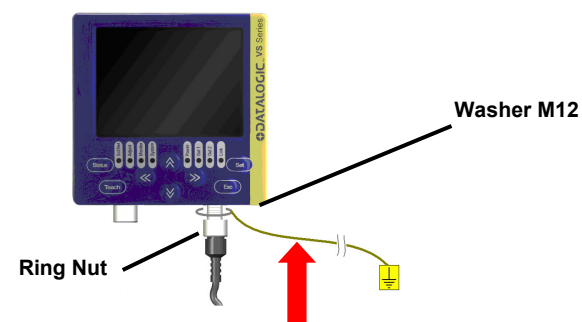

Insert the washer M12 on the yellow/green cable in the VSM connector and then screw the Ethernet cable until the ring nut reaches the washer.

Warnings

- Insert the cable into the correct connector following the key indications inside the body
- After inserting the cable, turn the ring nut anticlockwise to ensure connection
- Never force the cable inside the connectors.
- Make sure that every cable is connected to the right connector
- Before disconnecting the cable, completely turn the ring nut anticlockwise

VSM MOUNTING

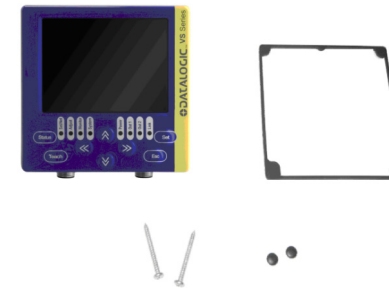

All the accessories for VSM mounting are included in the package. The VSM unit can be installed on a DIN rail or on a panel.

DIN RAIL MOUNTING

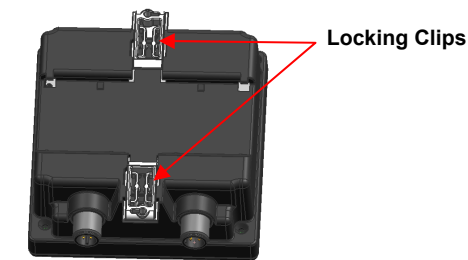

Wedge the VSM unit in the DIN rail. First set the upper part of the monitor and then press down the lower part.

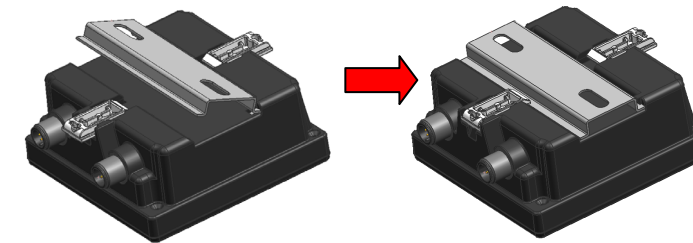

Once inserted, block the VSM monitor using the two white side locking clips.

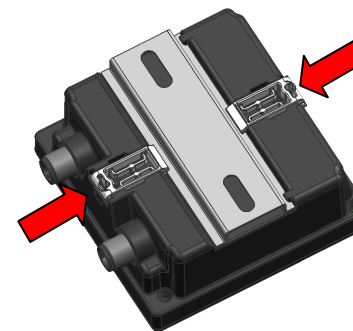

PANEL MOUNTING

Place the rubber seal around the monitor body.

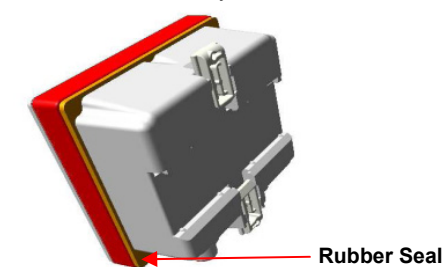

Then fix the monitor on the panel using the two locking screws and the two rubber caps.

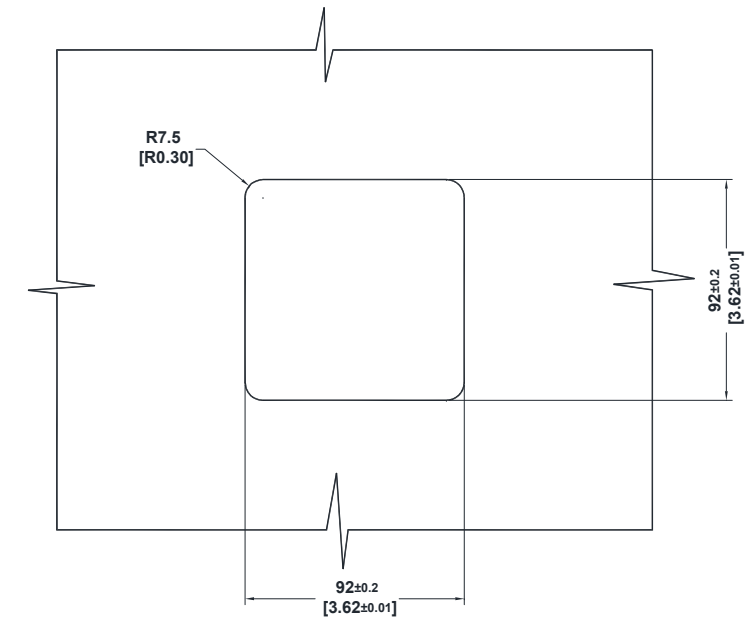
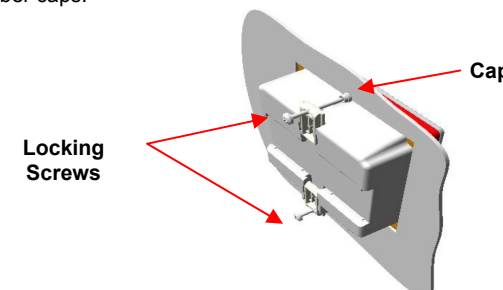

Panel Cutout

TECHNICAL DATA

Supply Voltage:	24 Vdc ± 10%
Ripple Voltage:	2.4 Vpp max
Current Draw:	Max 150 mA @ 24 Vdc
Dimensions:	96 x 96 x 39 mm
Indicators:	8 LEDs + 3.5" LCD color display
Setup:	DataVS2 GUI
Data Retention:	non volatile FLASH memory
Operating Temperature:	-10 °C ... +55 °C
Storage Temperature:	-20 °C ... +70 °C
Vibrations: (EN60068-2-6)	14 mm @ 2 to 10 Hz; 1.5 mm @ 13 to 55 Hz; 2 g @ 70 to 200 Hz; 2 hours on each axis
Shock Resistance: (EN60068-2-27)	11 ms (30 G) 6 shocks on each axis
Housing Material:	ABS
Mechanical Protection:	IP20 (IP40 when panel mounted)
Connections:	2 x M12 4-pin
Weight:	180 g

OVERALL DIMENSIONS

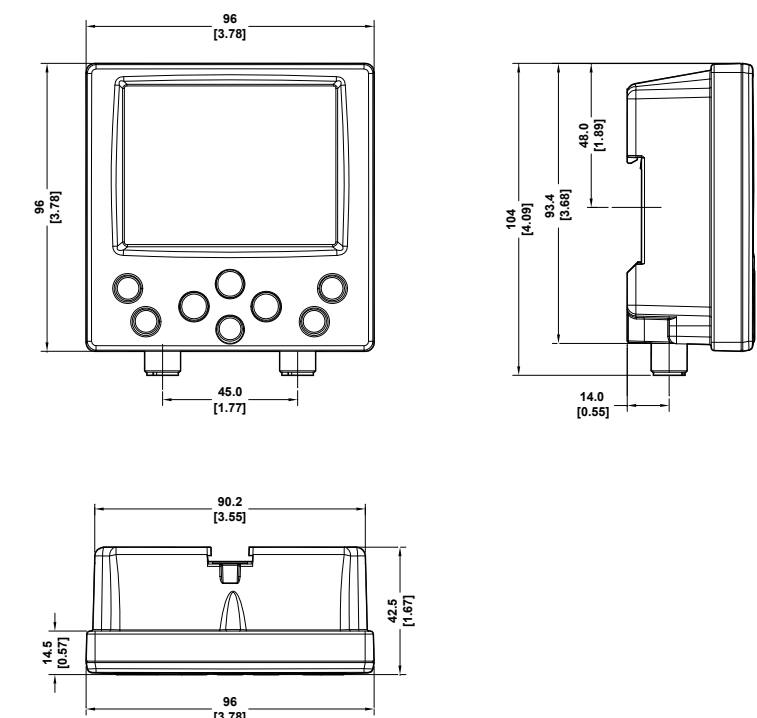

DEVICE USE

CONNECTION TO DATAVS2

To connect the VSM to DataVS2, just select the sensor from the list displayed in the "Net discovering" function.

Use the ARROW buttons to select the sensor and press SET to confirm the selection. If no devices have been found in the first discovery, a new search can be made by pressing TEACH.

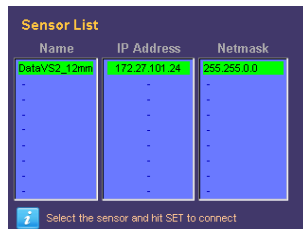

ADJUST MODE

Once connected the desired DataVS2, the VSM enters in the MONITOR mode and the current inspection is displayed together with the results of the relative tools.

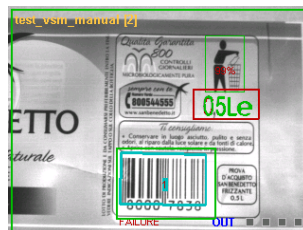

By pressing TEACH, the VSM will display the following panel:



At this point the user can choose to change the current inspection or modify the parameters.

Change of the Sensor Parameters and Tools

Selecting "Adjust Current Inspection" the user accesses the main panel of the Adjust status:



Only the parameters that have been previously enabled by the GUI as "Adjustable", can be displayed and changed.

By selecting "Camera", the user can access the parameters that adjust the brightness of the acquired image, exposure time, gain and operating mode of the illuminator.

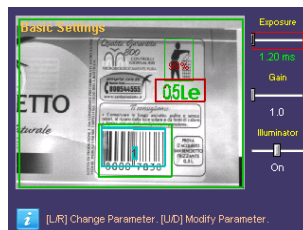

By selecting "Tools", the user can access the panel shown in the figure, and select the tools, on which changes are to be carried-out, using the arrows. Press SET to select the tool.



Once selected the tool, the user can scroll the panels relevant to the different parameters enabled as "Adjustable" using the ARROWS (right and left). The user can choose to move, resize or rotate the ROI by using the ARROW buttons (Up, Down) in the specific ROI adjustment panel. The adjustment can be carried-out using the 4 ARROW buttons once selected the operation by pressing SET.

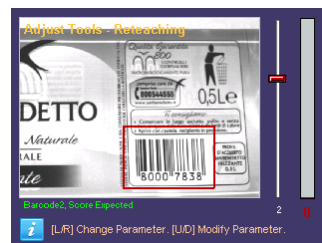

In panels that allow the change of the other parameters, the new value can be selected by moving the slider shown on the right side of the display. In order to correctly adjust parameters, these panels display the current inspection result relevant to the new configuration. The ROI contour and the result bar become green if the result is positive and red if negative.

Current Inspection Change

The following panel is displayed by pressing TEACH always from the monitor status:



By selecting "Change Current Inspection" the user can access another panel where the inspection to carry-out can be selected.

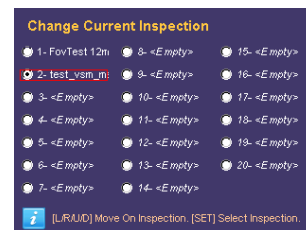

The inspection can be changed by simply pressing SET on the name of the desired inspection. At this point DataVS2 carries-out the new inspection and the monitor status is restored.

INSPECTION MONITORING AND SAVING

The monitor mode allows the user to control the result of the configured inspection. Different visualisations modes are available that can be recalled using the ARROW buttons. The SET button, instead, activates the statistics panel.

Monitor Mode	To Activate Press	View
Standard	Active by default	- Acquired image - Tool used - Result



Monitor Mode	To Activate Press	View
Tool Result	DOWN ARROW	- Tool result
Display on Condition	ESC BUTTON	- Acquired image - Tool used
Zoom	UP ARROW	- Acquired image (with 200% zoom) - Tool used - Result
Statistics	SET BUTTON	- Inspection result - Execution time - Inspections carried-out - Failure rate (%) - Score - Average score - MIN-MAX score

NOTE: The statistics of the single tools can be displayed by pressing STATUS.

MAIN SCREEN DESCRIPTION

The "System" panel is the main menu of the VSM unit and it allows the access to all the other panels and the relative functions available.

System



Press STATUS from Monitor mode to access the "System" panel. When the VSM is already connected to DataVS2, the "Disconnect" icon is displayed. To disconnect DataVS2, the icon has to be selected and SET pressed.

Monitor System Settings



This panel displays all the information relevant to the VSM unit such as name, serial number, model Firmware version, etc...

This panel allows changing the network parameters such as IP Address and NetMask. The data relevant to the last sensor connected are displayed on the bottom.

Sensor Settings

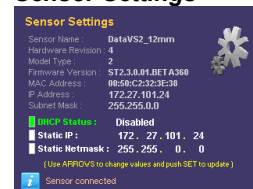

This panel is used to change the network parameters, when the VSM is connected to a DataVS2.

Memory Management

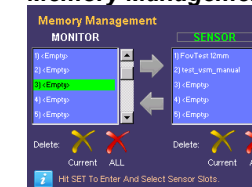

The control of the memory slots is divided in two parts: the "Monitor" section manages the VSM memory slots while the "Sensor" section manages the memory slots of the DataVS2. The slots can be cancelled and/or exchanged between the two devices.

Factory Reset



The reset of the default settings of the VSM is possible. All the memory slots are going to be cancelled, the network parameters changed and passwords cancelled.

Sensor List

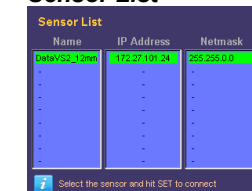

Once carried-out a "Net discovery", the list of DataVS2 devices present in the subnet connected to the VSM, is displayed. To connect the desired sensor, the user has to simply select it from the list and press SET.

Account Selection

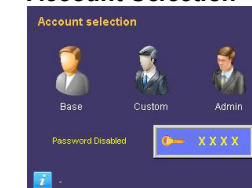

The user typology can be changed in this panel. To proceed with the changes, the user has to simply digit the password relevant to the new typology.

Language



The "Language" panel allows to change the language system of the device.

COMPLIANCE

Only connect Ethernet and dataport connections to a network which has routing only within the plant or building and no routing outside the plant or building.

CE COMPLIANCE

Warning: This is a Class A product. In a domestic environment this product may cause radio interference in which case the user may be required to take adequate measures.

FCC COMPLIANCE

Modifications or changes to this equipment without the expressed written approval of Datalogic could void the authority to use the equipment.

This device complies with PART 15 of the FCC Rules. Operation is subject to the following two conditions: (1) This device may not cause harmful interference, and (2) this device must accept any interference received, including interference which may cause undesired operation.

This equipment has been tested and found to comply with the limits for a Class A digital device, pursuant to part 15 of the FCC Rules. These limits are designed to provide reasonable protection against harmful interference when the equipment is operated in a commercial environment. This equipment generates, uses, and can radiate radio frequency energy and, if not installed and used in accordance with the instruction manual, may cause harmful interference to radio communications. Operation of this equipment in a residential area is likely to cause harmful interference in which case the user will be required to correct the interference at his own expense.

DECLARATION OF CONFORMITY

We DATALOGIC AUTOMATION declare under our sole responsibility that these products are conform to the 2004/108/CE and successive amendments.

WARRANTY

DATALOGIC AUTOMATION warrants its products to be free from defects. DATALOGIC AUTOMATION will repair or replace, free of charge, any product found to be faulty during the warranty period of 24 months from the manufacturing date. This warranty does not cover damage or liability deriving from the improper application of DATALOGIC products.

DATALOGIC AUTOMATION

Via Lavino 265 - 40050 Monte S. Pietro - Bologna - Italy
Phone: +39 051 6765611 Fax: +39 051 6759324
www.datalogic.com e-mail: info_automation@datalogic.com



DATALOGIC AUTOMATION for the environment: 100% recycled paper. DATALOGIC AUTOMATION reserves the right to make changes or improvements to products at any time without prior notice.

Datalogic and the Datalogic logo are registered trademarks of Datalogic S.p.A. in many countries, including the U.S.A. and the E.U.