

**ebm-papst St. Georgen GmbH & Co. KG**

Hermann-Papst-Str. 1

D-78112 St. Georgen

Phone +49 (0) 7724 81-0

Fax +49 (0) 7724 81-1309

info2@de.ebmpapst.com

www.ebmpapst.com

Nominal data

Type	9956	
Phase		1~
Nominal voltage	VAC	230
Frequency	Hz	50
Speed (rpm)	min ⁻¹	2450
Power consumption	W	14.0
Min. ambient temperature	°C	-40
Max. ambient temperature	°C	70
Air flow	m ³ /h	117
Sound power level	B	5.0
Sound pressure level	dB(A)	37

ml = Max. load · me = Max. efficiency · fa = Free air · cs = Customer specification · ce = Customer equipment
Subject to change



Technical description

Weight	0.325 kg
Dimensions	119 x 119 x 25 mm
Impeller material	Mineral-reinforced PA plastic
Housing material	Die-cast aluminum
Airflow direction	Exhaust over struts
Direction of rotation	Counterclockwise, viewed toward rotor
Storage	Ball bearing
Service life L10 at 40 °C	47500 h
Service life L10 at maximum temperature	22500 h
Cable	2 flat plugs 2.8 x 0.5 mm Grounding lug for M4
Motor protection	Protected from overload by impedance protection
Approval	VDE, CSA, UL, CE



Product drawing

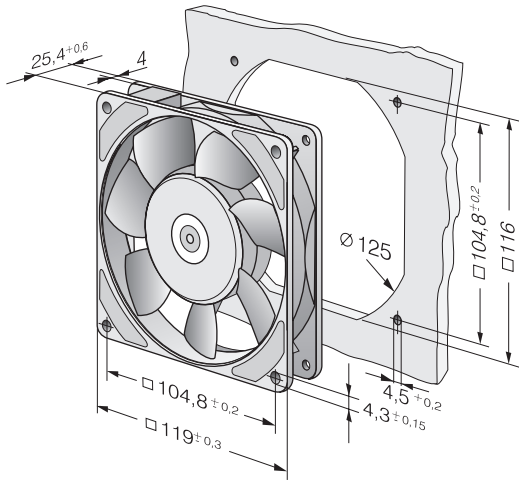

Curves: Air performance

