

# ARD-D Series

## DeviceNet Digital Remote I/O

### ■ Features

- Automatic communication speed recognition  
: Enables to recognize communication speed automatically when connecting with master
- Network Voltage monitoring  
: If PV is lower than SV, enables to receive error flag for network power monitoring as Explicit message.
- Additional expansion units
  - Standard terminal block type: Connectable up to 3 expansion units
  - Sensor connector type: Connectable up to 7 expansion units
- Expandable I/O points up to max. 64 points for Standard terminal type, sensor connector type
- Reading the number of expansion units  
: Reads the number of connected expansion units
- Reading model name: Reads the connected model name of connected units (sensor connector type)
- Reading the unit specifications: Reads the specifications of connected units

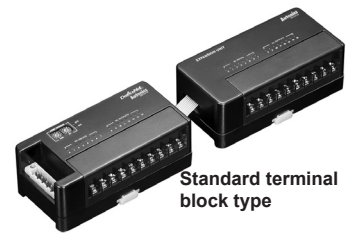

**⚠** Please read "Caution for your safety" in operation manual before using.



### ■ Ordering information

<b>AR</b>	<b>D</b>	<b>-</b>	<b>D</b>	<b>I</b>	<b>08</b>	<b>A</b>	<b>E</b>	<b>-</b>	<b>4S</b>	Terminal block <sup>※2</sup>			
										No-mark	Standard terminal block type		
										4S	Sensor connector type(4pin)		
										No-mark	Basic unit		
										E <sup>※4</sup>	Expansion unit		
										A	AC voltage	R	Relay
										N	NPN open collector	S	SSR
										P	PNP open collector		
										08	8 points type		
										16	16 points type		
										I	Input type		
										O	Output type		
										X	I/O mixed type		
										D	Digital type		
										A <sup>※5</sup>	Analog type		
										D	Basic unit(DeviceNet type)		
										X <sup>※3</sup>	Expansion unit(use in DeviceNet/Modbus)		
										AR	Autonics Remote I/O		

※1: Sensor connector type (ARD-□□-4S) model is only for NPN, PNP I/O specifications.

※2: Sensor connector(CNE-P04-□) is sold separately. It is compatible with e-CON connector.

※3: It is only for an expansion unit of sensor connector type.

※4: It is only for an expansion unit of standard terminal block type.

※5: For ARD-A Series as analog type, refer to S-13 page.

### ■ Model

Model	Specification		
Terminal type	Basic unit	Expansion unit	Specification
Standard terminal block type	ARD-DI08A	ARD-DI08AE	75-250VAC input 8-point(13mA/point)
	ARD-DI16N	ARD-DI16NE	10-28VDC NPN input 16-point(10mA/point)
	ARD-DI16P	ARD-DI16PE	10-28VDC PNP input 16-point(10mA/point)
	ARD-DO08R	ARD-DO08RE	Relay output 8-point(2A/point), Life cycle of contact : 100,000 times
	ARD-DO08S	ARD-DO08SE	SSR output 8-point(1A/point)
	ARD-DO16N	ARD-DO16NE	NPN output 16-point(0.5A/point)
	ARD-DO16P	ARD-DO16PE	PNP output 16-point(0.5A/point)
	ARD-DX16N	ARD-DX16NE	10-28VDC NPN input 8-point(10mA/point), NPN output 8-point(0.5A/point)
	ARD-DX16P	ARD-DX16PE	10-28VDC PNP input 8-point(10mA/point), PNP output 8-point(0.5A/point)
Sensor connector type	ARD-DI08N-4S	ARX-DI08N-4S	10-28VDC NPN input 8-point(10mA/point)
	ARD-DI08P-4S	ARX-DI08P-4S	10-28VDC PNP input 8-point(10mA/point)
	ARD-DO08N-4S	ARX-DO08N-4S	NPN output 8-point(0.3A/point)
	ARD-DO08P-4S	ARX-DO08P-4S	PNP output 8-point(0.3A/point)

# DeviceNet Digital Remote I/O

## ■ Specifications

Type		Standard terminal block type								
Model	Basic unit	ARD-DI08A	ARD-DI16N	ARD-DI16P	ARD-DO08R	ARD-DO08S	ARD-DO16N	ARD-DO16P	ARD-DX16N	ARD-DX16P
	Expansion unit	ARD-DI08AE	ARD-DI16NE	ARD-DI16PE	ARD-DO08RE	ARD-DO08SE	ARD-DO16NE	ARD-DO16PE	ARD-DX16NE	ARD-DX16PE
Power supply		Rated voltage: 24VDC, Voltage range: 12-28VDC								
Power consumption		Max. 3W								
Insulation type		Photocoupler isolated								
I/O points		AC input 8-point	NPN input 16-point	PNP input 16-point	Relay output 8-point	SSR output 8-point	NPN output 16-point	PNP output 16-point	NPN input 8-point + output 8-point	PNP input 8-point + output 8-point
Control I/O	Voltage	75-250VAC	10-28VDC		Normally open(N.O.) 250VAC 2A 1a	30-250VAC	10-28VDC(voltage drop: max. 0.5VDC)			
	Current	13mA/point	10mA/point			1A/point	0.5A/point (leakage current: max. 0.5 mA)	Input: 10mA, Output: 0.5A/point (leakage current: max. 0.5mA)		
Common		8-point, common			1-point, COM	8-point, common				
Insulation resistance		Min. 200MΩ(at 500VDC megger)								
Noise resistance		±240 V the square wave noise (pulse width: 1μs) by the noise simulator								
Dielectric strength		1000 VAC 50/60 Hz for 1 min.								
Vibration		1.5 mm amplitude at frequency of 10 to 55Hz (for 1 min.) in each of X, Y, Z directions for 2 hours								
Shock		500 m/s <sup>2</sup> (approx. 50G) in X, Y, Z directions for 3 times								
Environment	Ambient temperature	-10 to 50°C, storage : -25 to 75 °C								
	Ambient humidity	35 to 85%RH, storage : 35 to 85%RH								
Protection		IP20(IEC standard)								
Protection circuit		Surge protection circuit, Reverse polarity protection circuit (common) ● Transistor output type - Overcurrent protection circuit (NPN type : operated at min. 1.9A → re-supply power in overcurrent status, PNP type : operated at min. 0.7A), Overheating protection circuit(Min. 165°C), Short-circuit protection circuit								
Indicator		Network status (NS) LED (green, red), Unit status (MS) LED (green, red), I/O status LED (input: green, output: red)								
Material		Front case, Body Case: PC, Rubber cap: NBR								
Mounting		DIN rail or screw lock type								
Approval		DeviceNet CE DeviceNet		DeviceNet		CE DeviceNet				
Unit weight		Approx. 150g	Approx. 140g	Approx. 160g	Approx. 170g	Approx. 140g				

※Environment resistance is rated at no freezing or condensation.

Type		Sensor connector type								
Model	Basic unit	ARD-DI08N-4S			ARD-DI08P-4S		ARD-DO08N-4S		ARD-DO08P-4S	
	Expansion unit	ARX-DI08N-4S			ARX-DI08P-4S		ARX-DO08N-4S		ARX-DO08P-4S	
Power supply		Rated voltage: 24VDC, Voltage range: 12-28VDC)								
Power consumption		Max. 3W								
Insulation type		Photocoupler isolated								
I/O points		NPN input 8-point			PNP input 8-point		NPN output 8-point		PNP output 8-point	
Control I/O	Voltage	10-28VDC					10-28VDC(voltage drop: max. 0.5VDC)			
	Current	10mA/point(Sensor current: 150 mA/point)				0.3A/point(leakage current: max.0.5mA)				
Common		8-point, common								
Insulation resistance		Min. 200MΩ(at 500VDC megger)								
Noise resistance		±240V the square wave noise (pulse width: 1μs) by the noise simulator								
Dielectric strength		1,000VAC 50/60Hz for 1min. (between external terminals and case)								
Vibration		1.5mm amplitude at frequency of 10 to 55 Hz (for 1 min.) in each of X, Y, Z directions for 2 hours								
Shock		500m/s <sup>2</sup> (approx. 50 G) in X, Y, Z directions for 3 times								
Environment	Ambient temperature	-10 to 50°C, storage : -25 to 75°C								
	Ambient humidity	35 to 85%RH, storage : 35 to 85%RH								
Protection		IP20(IEC standard)								
Protection circuit		Surge, Short-circuit, Overheating (over 165 °C) and ESD protection, Reverse polarity protection circuit Overcurrent protection circuit(operated at min. 0.17A)   Over current protection circuit(operated at min. 0.7A)								
Indicator		Network status (NS) LED (green, red), Unit status (MS) LED (green, red), I/O status LED (Input: green, Output: red)								
Material		Front case, Body Case: PC								
Mounting		DIN rail or screw lock type								
Approval		CE DeviceNet								
Unit weight	Basic unit	Approx. 64 g			Approx. 64 g		Approx. 65 g		Approx. 67 g	
	Expansion unit	Approx. 56 g			Approx. 57 g		Approx. 58 g		Approx. 59 g	

※Environment resistance is rated at no freezing or condensation.

(A) Photo electric sensor

(B) Fiber optic sensor

(C) Door/Area sensor

(D) Proximity sensor

(E) Pressure sensor

(F) Rotary encoder

(G) Connector/Socket

(H) Temp. controller

(I) SSR/ Power controller

(J) Counter

(K) Timer

(L) Panel meter

(M) Tacho/ Speed/ Pulse meter

(N) Display unit

(O) Sensor controller

(P) Switching mode power supply

(Q) Stepper motor& Driver&Controller

(R) Graphic/ Logic panel

(S) Field network device

(T) Software

(U) Other

# ARD-D Series

## ■ DeviceNet communication

Item	Specifications
Communication	I/O Slave messaging(Group 2 Only slave) ·Poll command: Yes ·Bit_strobe command: Yes ·Cyclic command: Yes ·COS command: Yes
Communication distance	Max. 500m(125kbps), Max. 250m(250kbps), Max. 100m(500kbps)
NODE ADDRESS setting	Max. 64 nodes(set by the front rotary switch)
Communication speed	125, 250, 500kbps(automatically set when connecting with Master)
Insulation	I/O and inner circuit: Photocoupler isolated, DeviceNet and inner circuit: non-insulation, DeviceNet power: non-isolated
DeviceNet power	·Rated voltage: 24VDC ·Voltage range: 12-28VDC ·Power consumption: Max. 3W
Approval	ODVA Conformance tested

## ■ Part description

### ◎ Basic unit

#### ● Standard terminal block type

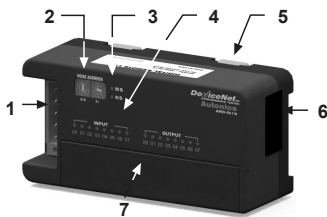

#### ● Sensor connector type

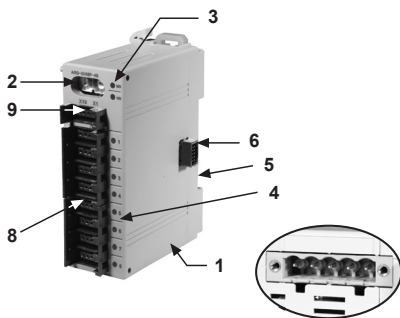

#### 1. DeviceNet connector

No.	Color	For	Organization
5	Red	24VDC(+)	
4	White	CAN_H	
3	None	Shield	
2	Blue	CAN_L	
1	Black	24DC(-)	

#### 2. Rotary switch for node address

: Rotary switch for setting node address.

×10 represents tens digit and ×1 represents ones digit.

**3. Status LED:** It displays the status of unit(MS) and network(NS).

**4. I/O status LED:** It displays each I/O status.

**5. Rail lock:** It is used for mounting DIN rail or with screw.

**6. Connector output part:** It connects an expansion unit.

**7. I/O terminal block:** It is used for connecting external device I/O.

**8. Sensor connector:** It is used for connecting external device I/O.

**9. External power connector:** It is used for supplying external power.

### ◎ Expansion unit

#### ● Standard terminal block type

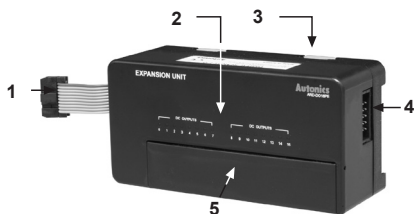

#### ● Sensor connector type

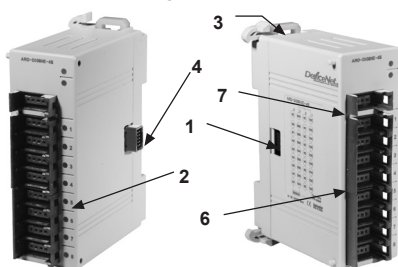

**1. Connector input part:** It connects expansion unit and is joined into expansion connector output.

**2. I/O status LED:** It displays each I/O status.

**3. Rail lock:** It is used for mounting DIN rail or with screw.

**4. Connector output part:** It connects an expansion unit.

**5. I/O terminal block:** It is used for connecting external device I/O.

**6. Sensor connector:** It is used for connecting external device I/O.

**7. External power connector:** It is used for supplying external power

# DeviceNet Digital Remote I/O

## I/O circuit diagram

### Standard terminal block type

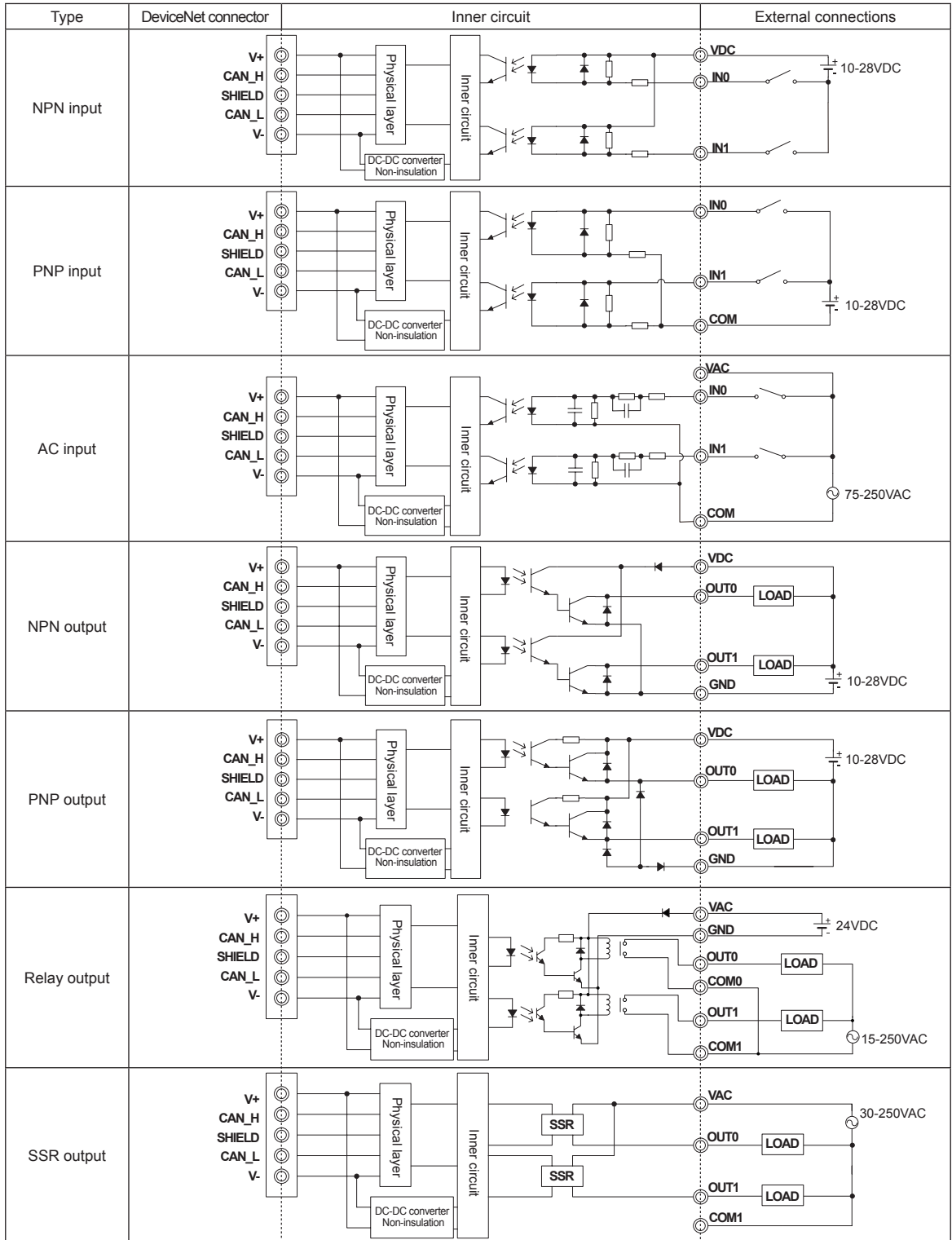

(A) Photo electric sensor

(B) Fiber optic sensor

(C) Door/Area sensor

(D) Proximity sensor

(E) Pressure sensor

(F) Rotary encoder

(G) Connector/Socket

(H) Temp. controller

(I) SSR/ Power controller

(J) Counter

(K) Timer

(L) Panel meter

(M) Tacho/ Speed/ Pulse meter

(N) Display unit

(O) Sensor controller

(P) Switching mode power supply

(Q) Stepper motor& Driver&Controller

(R) Graphic/ Logic panel

(S) Field network device

(T) Software

(U) Other

# ARD-D Series

## I/O circuit diagram

### Sensor connector type

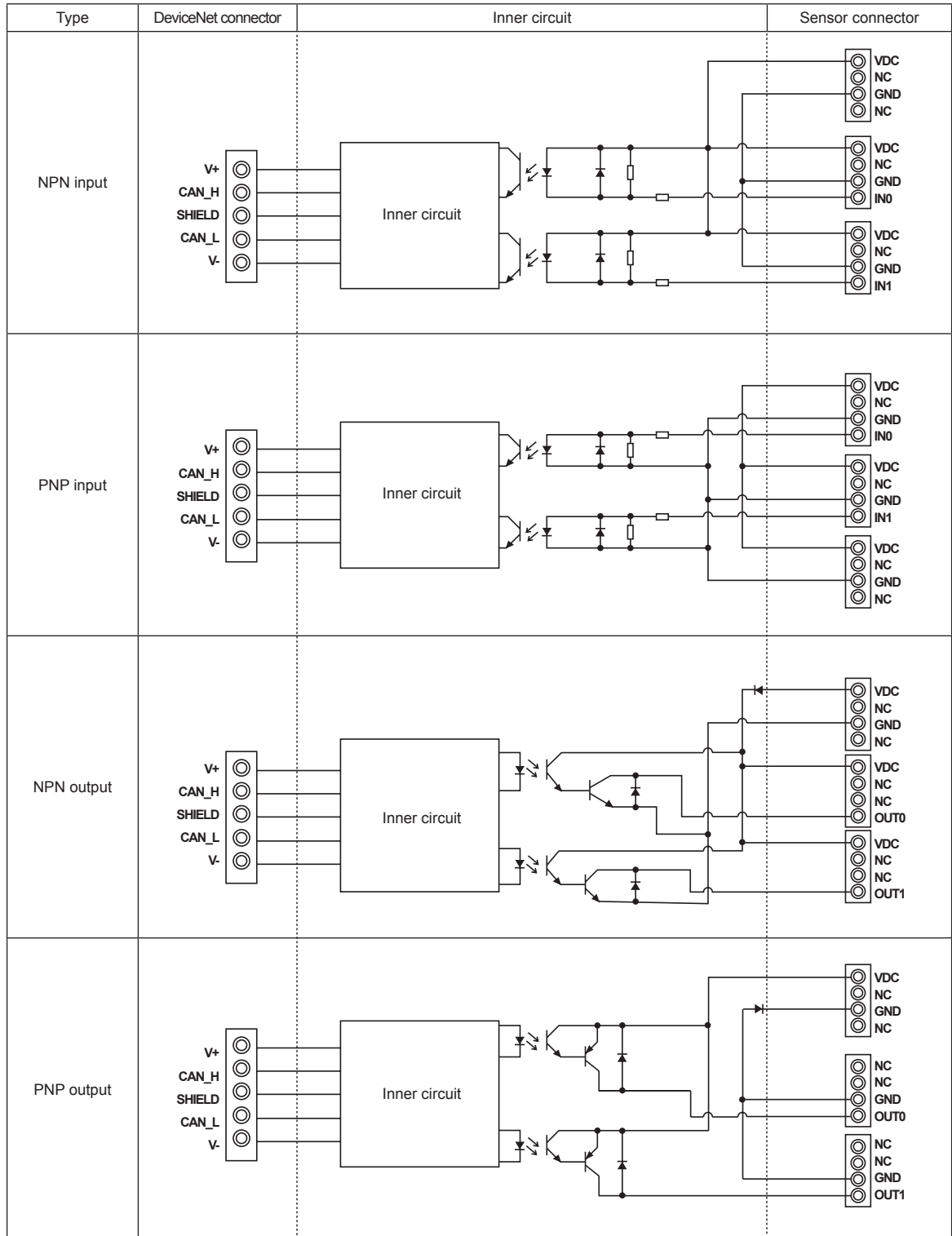

# DeviceNet Digital Remote I/O

## ■ Connections

### ◎ Standard terminal block type

#### ● ARD-DI08A(E) [AC input]

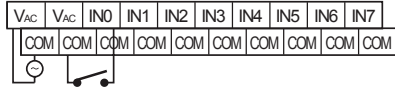

#### ● ARD-DI16N(E) [DC NPN input]

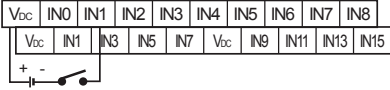

#### ● ARD-DO08R(E) [Relay output]

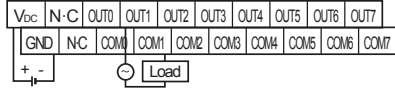

#### ● ARD-DO16N(E) [NPN output]

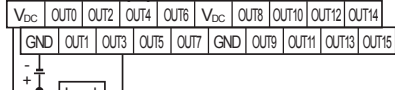

#### ● ARD-DX16N(E) [DC NPN input/DC NPN output]

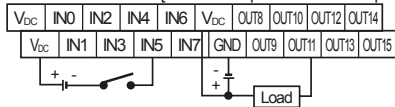

#### ● ARD-DI16P(E) [DC PNP input]

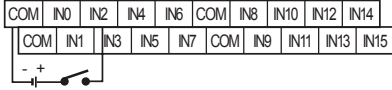

#### ● ARD-DO08S(E) [SSR output]

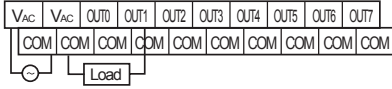

#### ● ARD-DO16P(E) [PNP output]

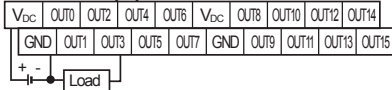

#### ● ARD-DX16P(E) [DC PNP input/DC PNP output]

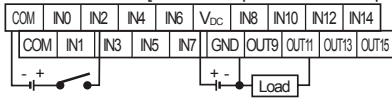

### ◎ Sensor connector type

#### ● AR□-DI08N-4S

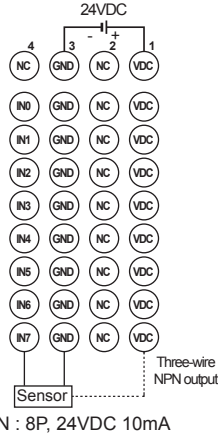

#### ● AR□-DI08P-4S

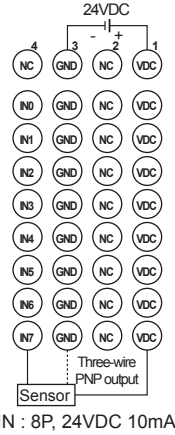

#### ● AR□-DO08N-4S

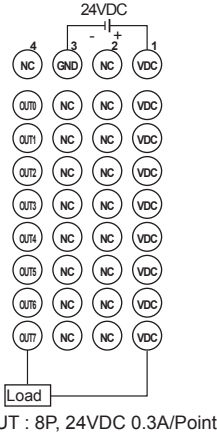

#### ● AR□-DO08P-4S

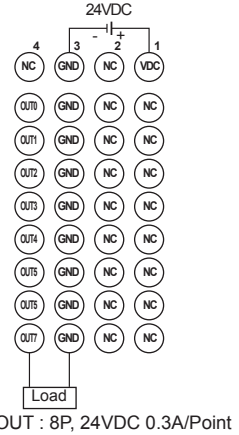

## ■ Dimensions

### ◎ Standard terminal block type

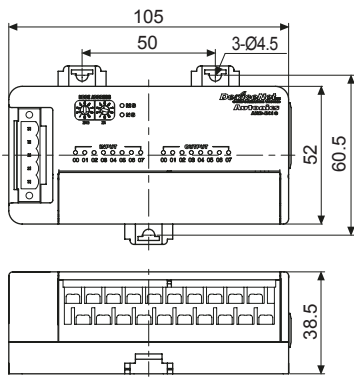

### ● Panel cut-out

(unit:mm)

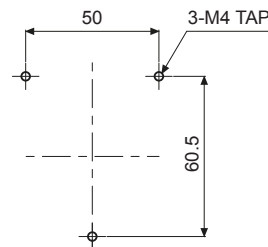

- ※ Tightening torque: 1.8 to 2.5N·m
- ※ Same dimensions are applied to both basic and expansion unit.
- ※ Connecting connectors are included for expansion units.

(A)	Photo electric sensor
(B)	Fiber optic sensor
(C)	Door/Area sensor
(D)	Proximity sensor
(E)	Pressure sensor
(F)	Rotary encoder
(G)	Connector/Socket
(H)	Temp. controller
(I)	SSR/Power controller
(J)	Counter
(K)	Timer
(L)	Panel meter
(M)	Tacho/Speed/Pulse meter
(N)	Display unit
(O)	Sensor controller
(P)	Switching mode power supply
(Q)	Stepper motor& Driver&Controller
(R)	Graphic/Logic panel
(S)	Field network device
(T)	Software
(U)	Other

# ARD-D Series

## ■ Dimensions

### ◎ Sensor connector type

#### ● Mounting on DIN rail

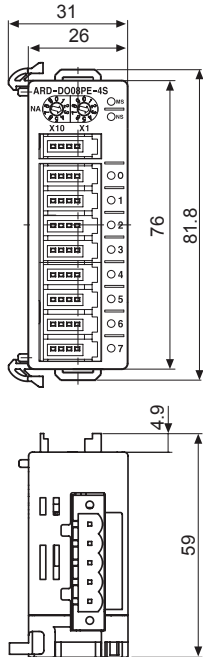

#### ● Mounting with screws

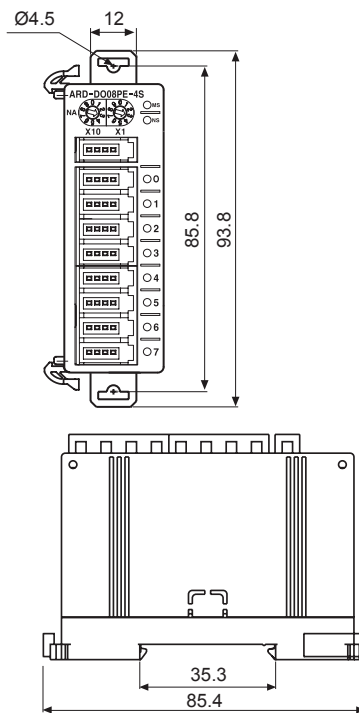

#### ● Connector

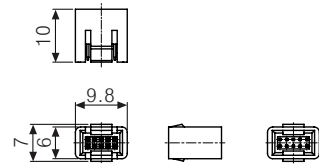

(unit:mm)

※Tightening torque: 1.8 to 2.5N·m

※Same dimensions are applied to both basic and expansion unit.

## ■ Status LED

(: ON, : Flash, : OFF)

Item	LED status		Description
	Red	Green	
Module status(MS) LED		●	Unrecoverable error
		●	Recoverable error & communication error of expansion unit
	●		Normal operation
	●	●	Power is not supplied
Network status(NS) LED	●		Normal standby
	●		Network On-Line
		●	Dupl. MAC ID / Bus-Off
		●	Time Out
	●	●	Network Off-Line

## ■ Installation and setup

### ◎ Node address setup

- Two rotary switches are used for setting node address.  
X10 switch represents the 10's multiplier and X10 switch represents the 1's multiplier.  
Node address is settable from 0 to 63.
- Node address is changed when re-supplying the power to the unit.  
After changing node address, must re-supply the power.

(Ex)

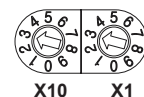

### ◎ Mounting on panel

- ① Pull Rail Locks(standard terminal block type: 3EA, sensor connector type: 2EA) on the rear part of a unit, there are fixing screw hole.
- ② Place the unit on a panel to be mounted.
- ③ Make holes on fixing screw positions.
- ④ Fasten the screw to fix the unit tightly.  
Tightening torque should be below 0.5N·m.



## ■ Installation and setup

### ○ Mounting on DIN rail

- ① Pull Rail Locks(standard terminal block type: 3EA, sensor connector type: 2EA) on the rear part of unit.
- ② Place the unit on DIN rail to be mounted.
- ③ Press Rail Locks to fix the unit tightly.

### ○ Connection of Basic unit and Expansion units (standard terminal block type)

- ① Turn OFF the power of a Basic unit.
- ② Place an expansion unit to be installed next to the basic unit.
- ③ Connect the cable of expansion unit to the connector of a basic unit.
- ④ Install a connected expansion units as the right figures.
- ⑤ Supply the power to a Basic unit.  
(Re-supply the power of a basic unit and it recognizes expansion units.)

### ○ Connection of Basic unit and Expansion units (sensor connector type)

- ① Turn OFF the power of the Basic unit.
- ② Remove a cover of connector for extension with nippers, etc.
- ③ Connect connector input part of an expansion unit and connector output part of a basic unit with a connector which is enclosed with an expansion unit box.
- ④ Install a connected expansion units as the right figure.
- ⑤ Supply the power to the Basic unit.  
(Re-supply the power of a basic unit and it recognizes expansion units.)



## ■ Communication distance

Baud Rate	Max. network length	Max. branch line length	Max. extended branch line length
125kbps	500m	6m	156m
250kbps	250m	6m	78m
500kbps	100m	6m	39m

## ■ Terminating resistance

- 120Ω ● 1% of metallic film ● 1/2W

※Do not install terminating resistance on the unit, or it may cause network terminating problem (Impedance can be too high or low) and trouble.

※Connect terminating resistance on the both ends of the trunk line.

## ■ Caution for using

- Turn OFF the power before connecting or disconnecting expansion units.
- Node addresses of connected units on network should not be duplicated. If you change a node address during operation, unit status (MS) red LED flashes and it communicates with a previous node address.  
Re-supply power and the changed node address is applied.
- Communication speed which is set on master is set automatically. If you change the communication speed during operation, network status (NS) red LED turns ON and it does not communicate.  
Re-supply power and it operates normally.
- Make sure to use DeviceNet standards communication cables, and taps.  
It may cause communication error if non-standards products are used.
- Make sure to examine disconnection or short-circuit before connecting cables.
- Avoid installing the units where severe dust exists or where corrosion may occur.
- Installation environment
  - It shall be used indoor.
  - Altitude Max. 2,000m
  - Pollution Degree 2
  - Installation Category II

(A) Photo electric sensor

(B) Fiber optic sensor

(C) Door/Area sensor

(D) Proximity sensor

(E) Pressure sensor

(F) Rotary encoder

(G) Connector/Socket

(H) Temp. controller

(I) SSR/Power controller

(J) Counter

(K) Timer

(L) Panel meter

(M) Tacho/Speed/ Pulse meter

(N) Display unit

(O) Sensor controller

(P) Switching mode power supply

(Q) Stepper motor& Driver&Controller

(R) Graphic/Logic panel

(S) Field network device

(T) Software

(U) Other